



Design Example Report

Title	<i>3.5W CV/CC Adapter using TNY264P</i>
Specification	Input: 90 – 265 VAC Output: 5.5V /0.65A
Application	Cell Phone Charger
Author	Power Integrations Applications Department
Document Number	DER-35
Date	April 5, 2004
Revision	1.0

Summary and Features

This document is an engineering report describing a cell phone charger power supply utilizing a TNY264P, with the following features:

- Low cost
- No Y-cap
- Meets EMI
- Very Low Leakage Current
- Does not require a TL431

The products and applications illustrated herein (including circuits external to the products and transformer construction) may be covered by one or more U.S. and foreign patents or potentially by pending U.S. and foreign patent applications assigned to Power Integrations. A complete list of Power Integrations' patents may be found at www.powerint.com.

Table Of Contents

1	Introduction.....	3
2	Power Supply Specification.....	4
3	Schematic.....	5
4	PCB Layout.....	6
5	Bill Of Materials.....	7
6	Transformer Specification.....	8
	6.1 Electrical Diagram.....	8
	6.2 Electrical Specifications.....	8
	6.3 Materials.....	8
	6.4 Transformer Build Diagram.....	9
	6.5 Transformer Construction.....	9
7	Transformer Spreadsheets.....	10
8	Performance Data.....	12
	8.1 Efficiency.....	12
	8.2 No-load Input Power.....	13
	8.3 Output Characteristic.....	13
	8.4 Line Regulation.....	14
9	Thermal Performance.....	15
10	Waveforms.....	16
	10.1 Drain Voltage and Current, Normal Operation.....	16
	10.2 Output Voltage Start-up Profile.....	16
	10.3 Drain Voltage and Current Start-up Profile.....	17
	10.4 Load Transient Response (75% to 100% Load Step).....	17
	10.5 Out put Ripple Measurements.....	18
	10.5.1 Ripple Measurement Technique.....	18
	10.5.2 Measurement Results.....	19
11	Conducted EMI.....	20
12	Revision History.....	21

Important Note:

Although this board is designed to satisfy safety isolation requirements, the engineering prototype has not been agency approved. Therefore, all testing should be performed using an isolation transformer to provide the AC input to the prototype board.

Design Reports contain a power supply design specification, schematic, bill of materials, and transformer documentation. Performance data and typical operation characteristics are included. Typically only a single prototype has been built.



1 Introduction

This document is an engineering report describing a cell phone charger power supply utilizing a TNY264P.

The document contains the power supply specification, schematic, bill of materials, transformer documentation, printed circuit layout, and performance data.

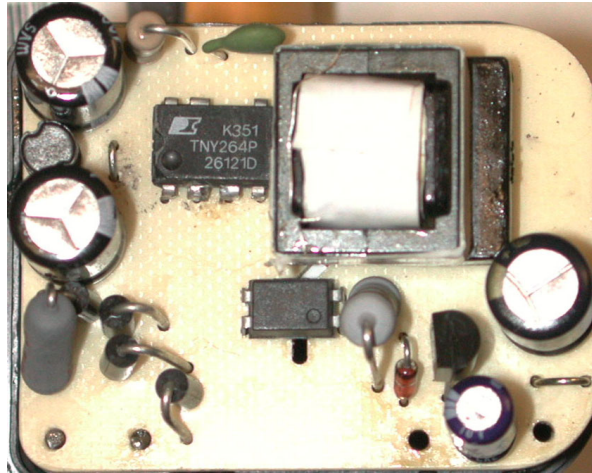

Figure 1 – Populated Circuit Board Photograph.



2 Power Supply Specification

Description	Symbol	Min	Typ	Max	Units	Comment
Input						
Voltage	V_{IN}	90	115/230	264	VAC	2 Wire – no P.E.
Frequency	f_{LINE}	47	50/60	63	Hz	
Output						
Output Voltage 1	V_{OUT1}	5.1	5.4	5.7	V	when in CV Mode 20 MHz Bandwidth when in CC mode
Output Ripple Voltage 1	$V_{RIPPLE1}$			100	mV	
Output Current 1	I_{OUT1}	600		720	mA	
Total Output Power						
Continuous Output Power	P_{OUT}		3.5		W	
Efficiency	η		55		%	Measured at Full Load Nominal Input Voltage 25 °C
Environmental						
Conducted EMI			Meets CISPR22B / EN55022B			
Safety			Designed to meet IEC950, UL1950 Class II			
Ambient Temperature	T_{AMB}	0	25	40	°C	Free convection, sea level



3 Schematic

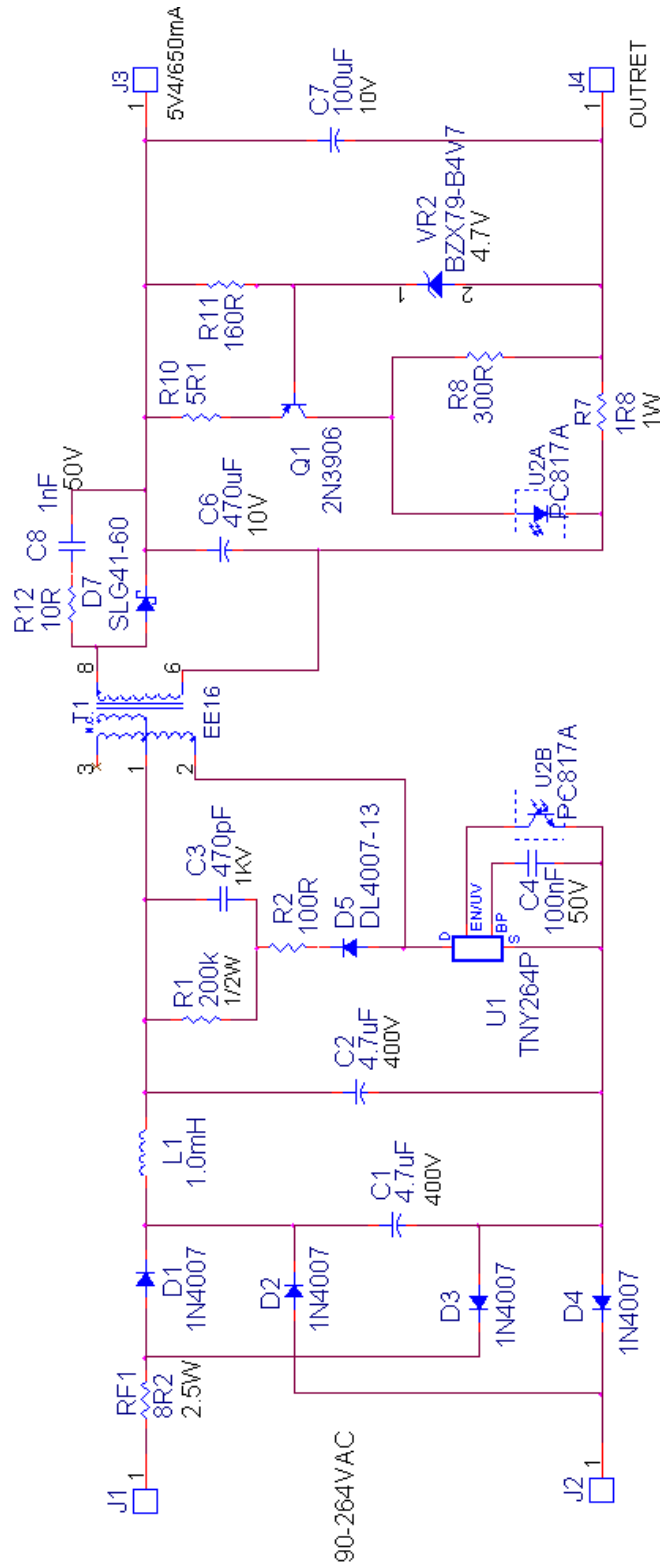

Figure 2 – Schematic.



4 PCB Layout

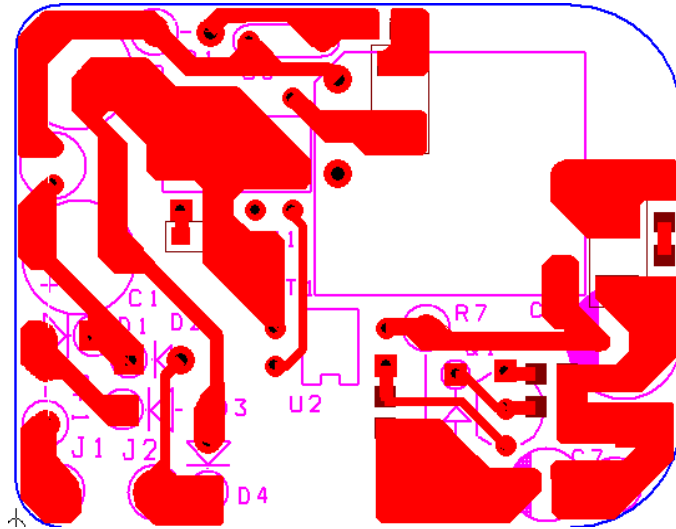

Figure 3 Printed Circuit Layout TOP Silk Screen and Copper Bottom Layers

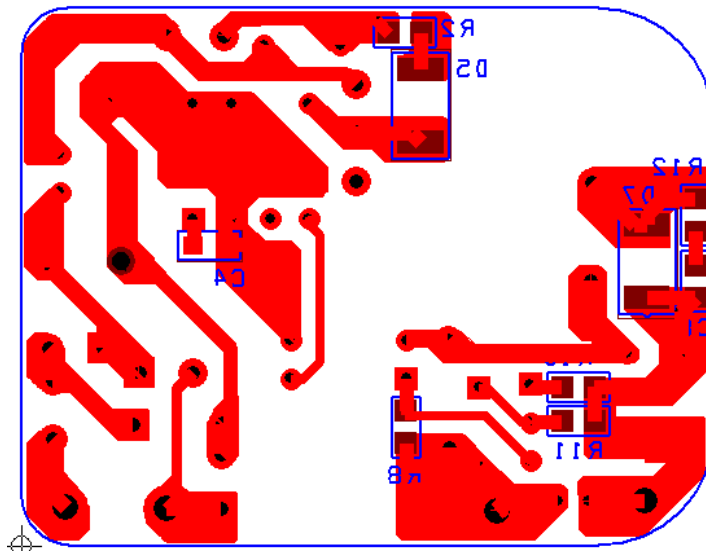

Figure 4 – Printed Circuit Layout. Bottom Silk Screen and Copper Bottom Layers.

5 Bill Of Materials

Item Number	Quantity	Part Reference	Description
1	2	C1 C2	Cap,Al Elect,4.7uF,400V,8mmX11.5mm,Sam Young
2	1	C3	Cap,Cer,470pF, 1000V, 10%
3	1	C4	CAP 0.1uF 50V CERM CHIP X7R 0805 SMD
4	1	C6	Cap,Al Elect,470uF,10V,8mmX11.5mm,KZE Series,NIPPON CHEMI-CON
5	1	C7	Cap,Al Elect,100uF,10V,5mmX11.5mm,LXZ Series,NIPPON CHEMI-CON
6	1	C8	CAP 1000pF 50V CERM CHIP X7R 0805 SMD
7	4	D1 D2 D3 D4	Rectifier GPP 1000V 1A DO-41
8	1	D5	RECT,DL4007-13 PASSIVATED 1A 1000V SMD MELF
9	1	D7	SLG41-60 DIODE SCHOTTKY,60V 1A
10	4	J1 J2 J3 J4	Terminal,1Pin,18AWG
11	1	L1	CHOKE,1mH,SBCP_47HY102B,TOKIN
12	1	Q1	TRANS,2N3906, PNP SS GP 200MA TO-92
13	1	R1	Res, 200K, 1/2W, 5%, Carbon Film
14	1	R2	Res,100 1/10W 5% 0805 SMD
15	1	R7	Res, 1.8 ,1W, 5%, Metal Film
16	1	R8	Res,300 1/10W 5% 0805 SMD
17	1	R10	Res,5.1 1/10W 5% 0805 SMD
18	1	R11	Res,160 1/10W 5% 0805 SMD
19	1	R12	Res,10 1/10W 5% 0805 SMD
20	1	RF1	Res, Wirewound,8.2 Ohm,2.5W,Flame Retardant
21	1	T1	BEE16_H_LOPROFILE_10P
22	1	U1	IC,TNY264P,L POWER SWITCHER 6W,DIP-8B
23	1	U2	IC,PC817A,PHOTOCOUPLER TRAN OUT CTR 80-160% 4-DIP
24	1	VR2	Diode, Zener, 4.7V, 1/2W, 2%, DO-35



6 Transformer Specification

6.1 Electrical Diagram

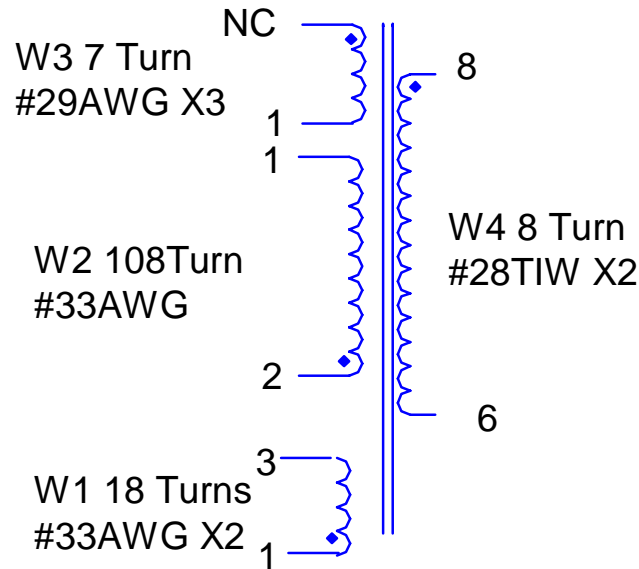

Figure 5 Transformer Electrical Diagram

6.2 Electrical Specifications

Electrical Strength	1 second, 60 Hz, from Pins 1-5 to Pins 6-10	3000 VAC
Primary Inductance	Pins 1-2, all other windings open, measured at 132 kHz,	2030 μ H, -/+10%
Resonant Frequency	Pins 1-2, all other windings open	620 kHz (Min.)
Primary Leakage Inductance	Pins 1-2, with Pins 6-8 shorted, measured at 132 kHz.	65 μ H (Max.)

6.3 Materials

Item	Description
[1]	Core: PC40EE16, TDK or equivalent Gapped for AL of 173nH/T ²
[2]	Bobbin: Horizontal 10 pin
[3]	Magnet Wire: #33 AWG
[4]	Magnet Wire: #29 AWG
[5]	Bus wire #29AWG
[6]	Triple Insulated Wire: #28 AWG.
[7]	Tape: 3M 1298 Polyester Film, 2.0 mils thick, 8.4 mm wide
[8]	Varnish

6.4 Transformer Build Diagram

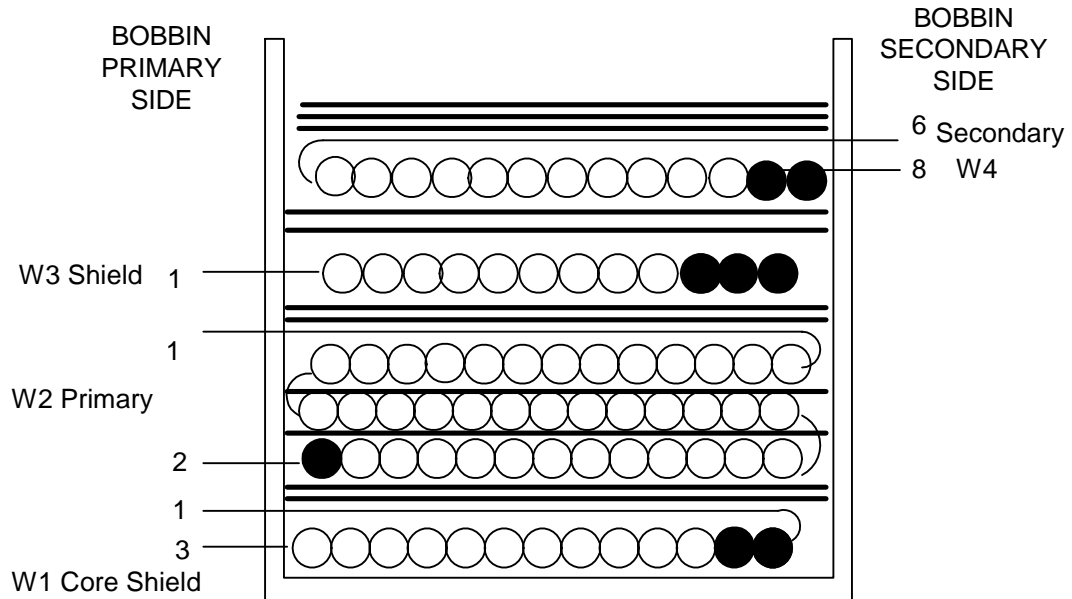

Figure 6 – Transformer Build Diagram.

6.5 Transformer Construction

Bobbin Preparation	Place the bobbin item [2] in the winding machine with primary side oriented to the left hand side.
Core Cancellation	Start at Pin 8 temporarily. Wind 18 bifilar turns of item [3] from right to left. Wind uniformly with tight tension across winding area. Finish on pin 3 Fold and attach the starting lead to pin 1
Basic Insulation	Use two layers of item [7] for basic insulation.
Primary	Start at pin 2 wind 36 turns of item [3] from left to right, apply one layer of item [7]. Continue winding on a second layer. Wind 36 turns from right to left, apply one layer of item [7]. On a third layer wind 36 turns from left to right. Wind with tight tension across entire bobbin. Finish at pin 1
Basic Insulation	Use two layers of item [7] for basic insulation.
Shield	Start at Pin 8 temporarily, wind 7 trifilar turns of item [4]. Wind from right to left with tight tension in a single layer across entire width of bobbin. Finish on Pin 1.
Shield	Cut the starting lead right where the winding begins
Basic Insulation	Use two layer of item [7] for basic insulation.
Secondary Winding	Start at Pins 8. Wind 8 bifilar turns of item [6] Spread turns evenly across bobbin. Finish on Pin 6.
Outer Wrap	Use two layer of item [7] for basic insulation.
Core Preparation	Assembly cores halves. Wind two turns of item [5] around the core. The wire should be placed very close to the primary pin side of the bobbin. Terminate the wire at pin 1.
Final Assembly	Varnish impregnate (item [8]). Cut pins 4,5,7,9,and 10 of Bobbin [2]



7 Transformer Spreadsheets

ACDC_TNY-II_Rev1_1_032701 Copyright Power Integrations Inc. 2001		INPUT	INFO	OUTPUT	UNIT	ACDC_TNYII_Rev1_1_032701.xls: TinySwitch-II Continuous/Discontinuous Flyback Transformer Design Spreadsheet
ENTER APPLICATION VARIABLES						TRANSFORMER 1
VACMIN		90			Volts	Minimum AC Input Voltage
VACMAX		265			Volts	Maximum AC Input Voltage
fL		47			Hertz	AC Mains Frequency
VO		5.4			Volts	Output Voltage
PO		4.468979			Watts	Output Power
n		62				Efficiency Estimate
Z		0.67				Loss Allocation Factor
tC		0.5				Bridge Rectifier Conduction Time Estimate
CIN		3			mSeconds	Bridge Rectifier Conduction Time Estimate
		9.4			uFarads	Input Filter Capacitor
ENTER TinySwitch-II VARIABLES						
TNY-II		TNY264			Universal	115 Doubled/230V
Chosen Device			TNY264	Power Out	6W	9W
ILIMITMIN				0.233	Amps	TINYSwitch Minimum Current Limit
ILIMITMAX				0.267	Amps	TINYSwitch Maximum Current Limit
fS				132000	Hertz	TINYSwitch Switching Frequency
fSmin				120000	Hertz	TINYSwitch Minimum Switching Frequency (inc. jitter)
fSmax				144000	Hertz	TINYSwitch Maximum Switching Frequency (inc. jitter)
VOR		80			Volts	Reflected Output Voltage
VDS		10			Volts	TINYSwitch on-state Drain to Source Voltage
VD		0.5			Volts	Output Winding Diode Forward Voltage Drop
KP				0.60		Ripple to Peak Current Ratio (0.6<KRP<1.0 : 1.0<KDP<6.0)
ENTER TRANSFORMER CORE/CONSTRUCTION VARIABLES						
Core Type		EE16				
Core			EE16		P/N:	PC40EE16-Z
Bobbin			EE16_BOBBIN		P/N:	BE-16-118CPH
AE				0.192	cm^2	Core Effective Cross Sectional Area
LE				3.5	cm	Core Effective Path Length
AL				1140	nH/T^2	Ungapped Core Effective Inductance
BW				8.6	mm	Bobbin Physical Winding Width
M		0			mm	Safety Margin Width (Half the Primary to Secondary Creepage Distance)
L		3				Number of Primary Layers
NS		8				Number of Secondary Turns
DC INPUT VOLTAGE PARAMETERS						
VMIN				73	Volts	Minimum DC Input Voltage
VMAX				375	Volts	Maximum DC Input Voltage
CURRENT WAVEFORM SHAPE PARAMETERS						
DMAX				0.56		Maximum Duty Cycle
I AVG				0.09	Amps	Average Primary Current
IP				0.23	Amps	Minimum Peak Primary Current
IR				0.14	Amps	Primary Ripple Current
IRMS				0.13	Amps	Primary RMS Current
TRANSFORMER PRIMARY DESIGN PARAMETERS						
LP				2035	uHenries	Primary Inductance
NP				108		Primary Winding Number of Turns
ALG				173	nH/T^2	Gapped Core Effective Inductance
BM				2609	Gauss	Flux Density, IP (BP<3000)
BAC				683	Gauss	AC Flux Density for Core Loss Curves (0.5 X Peak to Peak)
ur				1654		Relative Permeability of Ungapped Core
LG				0.12	mm	Gap Length (Lg > 0.1 mm)



BWE			25.8	mm	Effective Bobbin Width
OD			0.24	mm	Maximum Primary Wire Diameter including insulation
INS			0.05	mm	Estimated Total Insulation Thickness (= 2 * film thickness)
DIA			0.19	mm	Bare conductor diameter
AWG			33	AWG	Primary Wire Gauge (Rounded to next smaller standard AWG value)
CM			51	Cmils	Bare conductor effective area in circular mils
CMA			405	Cmils/Amp	Primary Winding Current Capacity (200 < CMA < 500)
TRANSFORMER SECONDARY DESIGN PARAMETERS (SINGLE OUTPUT / SINGLE OUTPUT EQUIVALENT)					
Lumped parameters					
ISP			3.16	Amps	Peak Secondary Current
ISRMS			1.51	Amps	Secondary RMS Current
IO			0.83	Amps	Power Supply Output Current
IRIPPLE			1.27	Amps	Output Capacitor RMS Ripple Current
CMS			303	Cmils	Secondary Bare Conductor minimum circular mils
AWGS			25	AWG	Secondary Wire Gauge (Rounded up to next larger standard AWG value)
DIAS			0.46	mm	Secondary Minimum Bare Conductor Diameter
ODS			1.08	mm	Secondary Maximum Outside Diameter for Triple Insulated Wire
INSS			0.31	mm	Maximum Secondary Insulation Wall Thickness
VOLTAGE STRESS PARAMETERS					
VDRAIN			563	Volts	Maximum Drain Voltage Estimate (Includes Effect of Leakage Inductance)
PIVS			33	Volts	Output Rectifier Maximum Peak Inverse Voltage



8 Performance Data

All measurements performed at room temperature, 60 Hz input frequency.

8.1 Efficiency

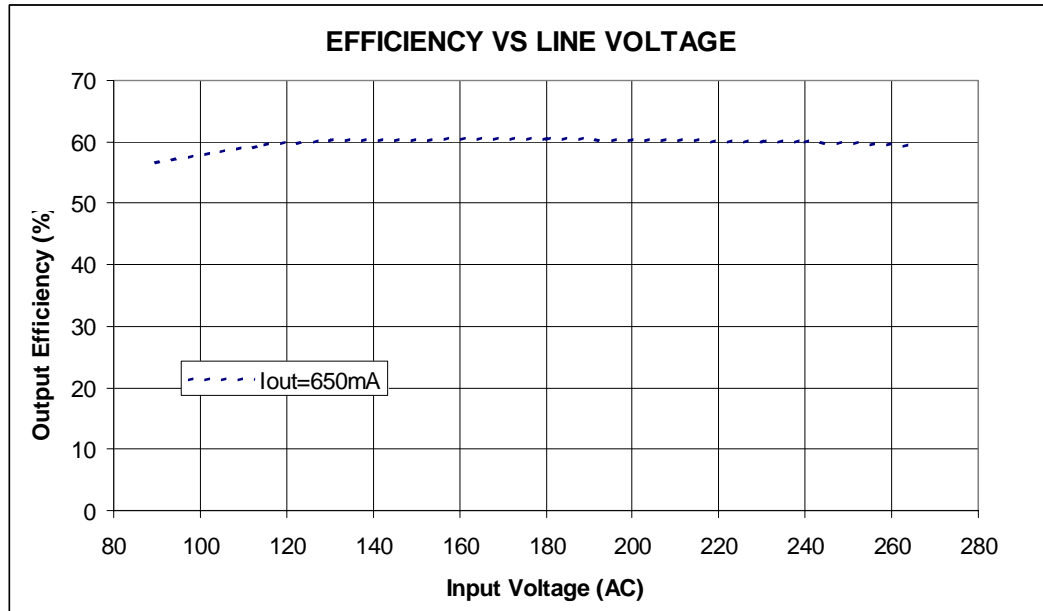

Figure 7- Efficiency vs. Input Voltage, Room Temperature, 60 Hz.

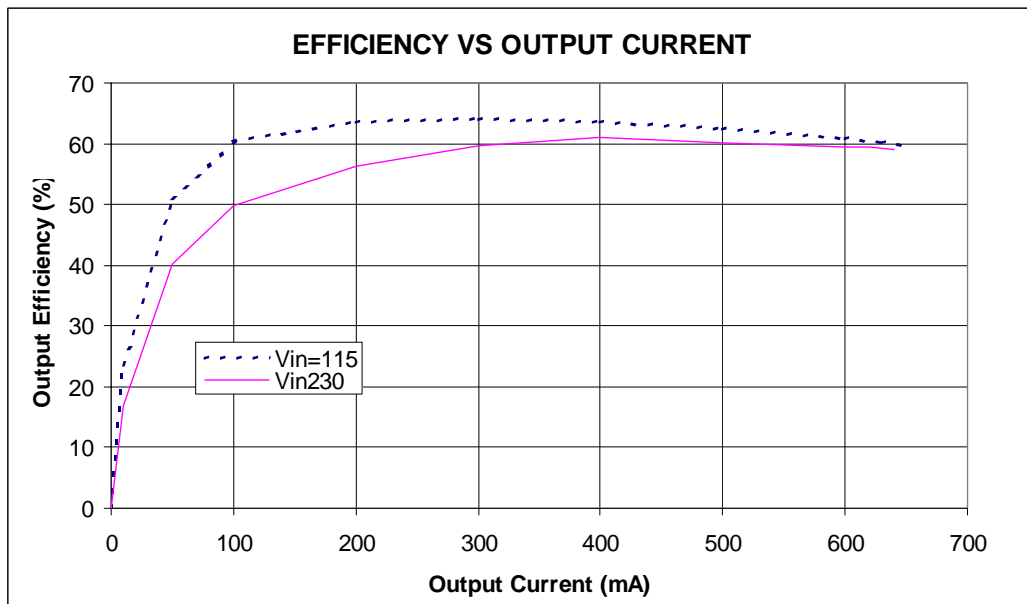

Figure 8. Efficiency VS Output Load. Room Temperature, 60 Hz.



8.2 No-load Input Power

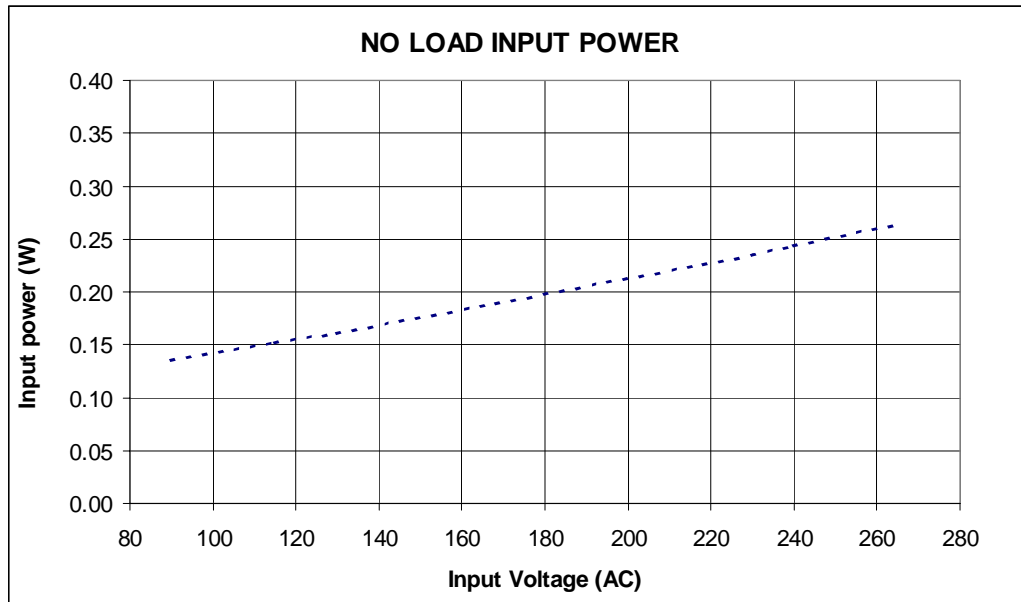

Figure 9- Zero Load Input Power vs. Input Line Voltage, Room Temperature, 60 Hz.

8.3 Output Characteristic.

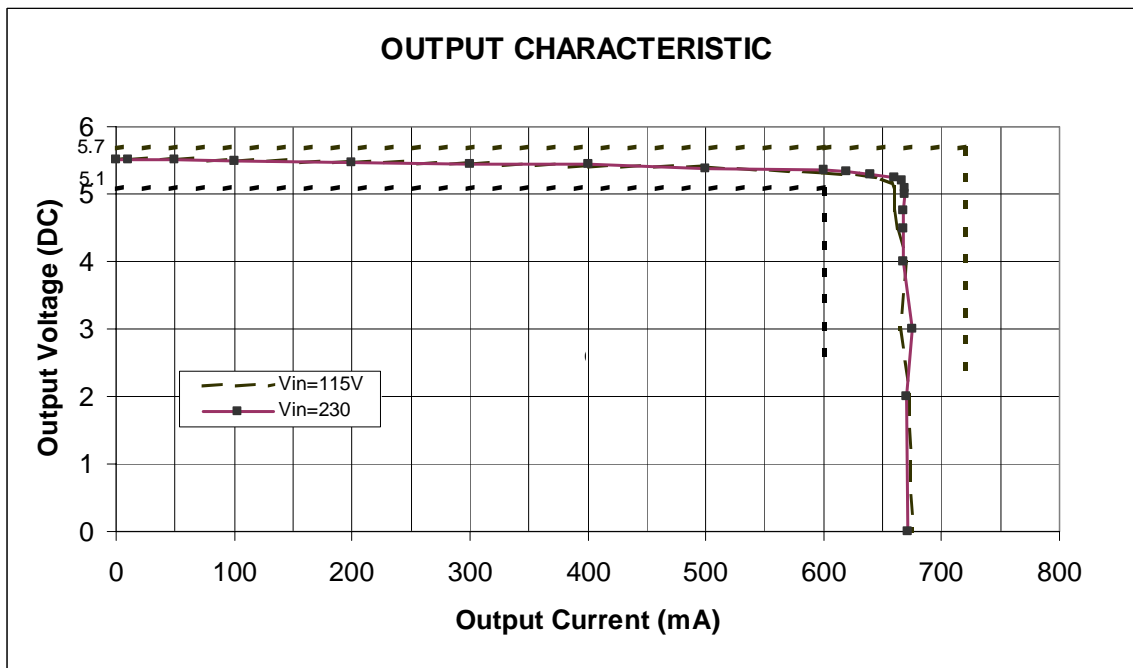

Figure 10 –Output Characteristic, 25 °C



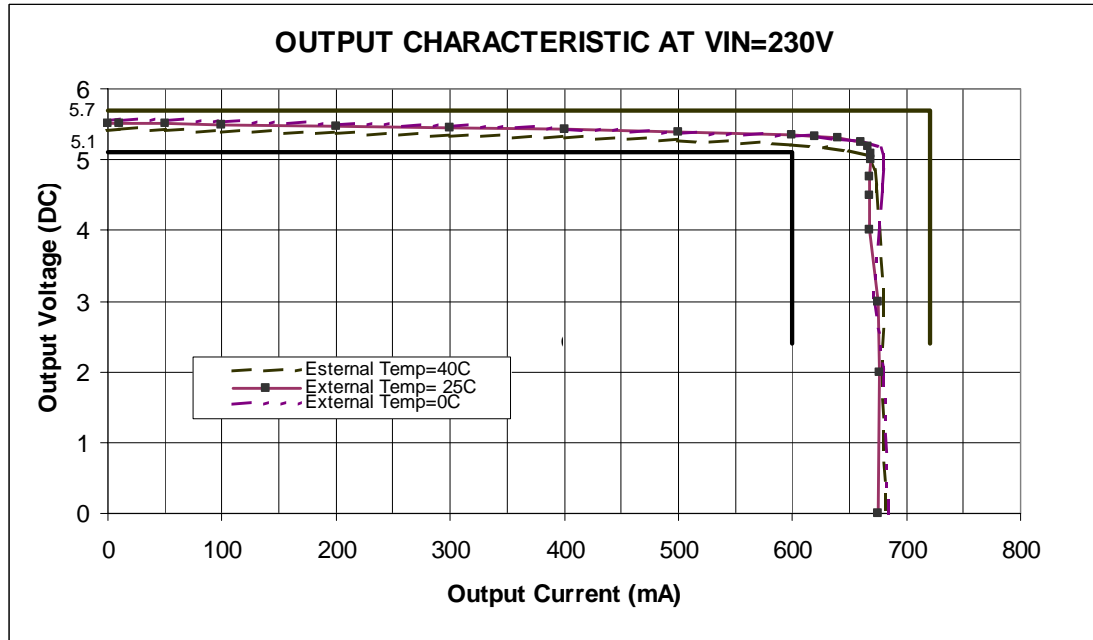

Figure 11. Output Characteristic at different ambient temperatures

8.4 Line Regulation

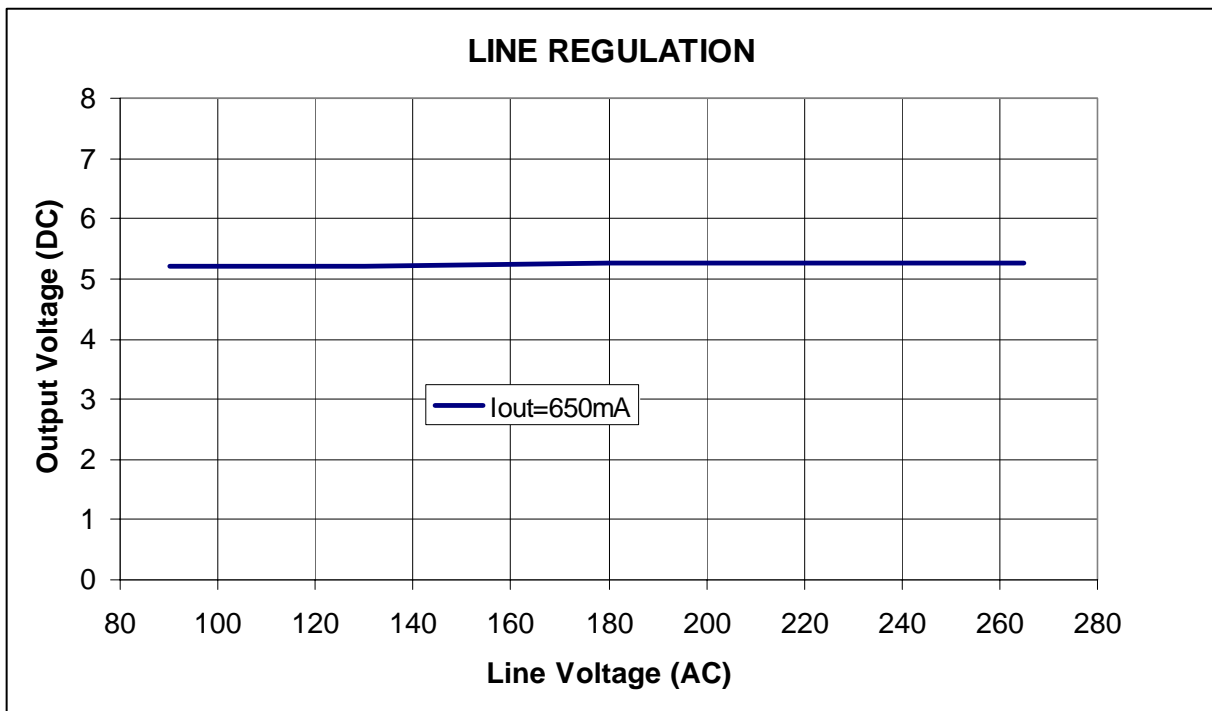

Figure 12 – Line Regulation, Room Temperature, Full Load.



9 Thermal Performance

Measurements were done with the supply enclosed in its case.

Temperature (°C)			
Item	Vin=90VAC	Vin=115VAC	Vin=230VAC
Ambient (C)	25	25	25
Transformer (T1)	73	70	69
Blocking Diode (D5)	71	67	65
<i>TinySwitch-II</i> (U1)	97	77	69
Output Rectifier (D7)	69	68	67



10 Waveforms

10.1 Drain Voltage and Current, Normal Operation

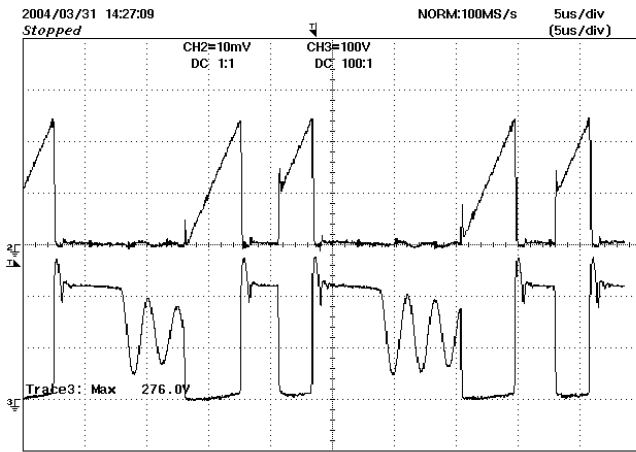

Figure 13 - 90 VAC, Full Load.
Upper: I_{DRAIN} , 0.1 A / div
Lower: V_{DRAIN} , 100 V, 5 μ s / div

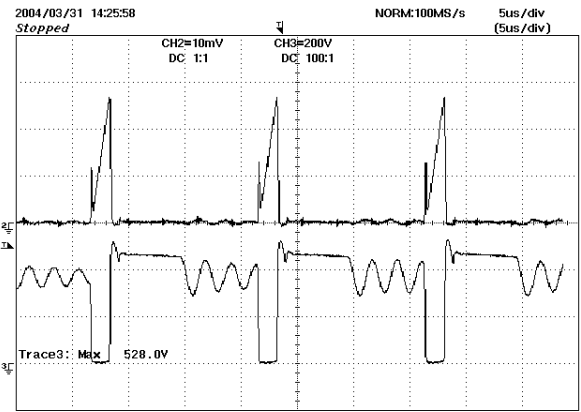

Figure 14 - 264 VAC, Full Load
Upper: I_{DRAIN} , 0.1 A / div
Lower: V_{DRAIN} , 200 V / div

10.2 Output Voltage Start-up Profile

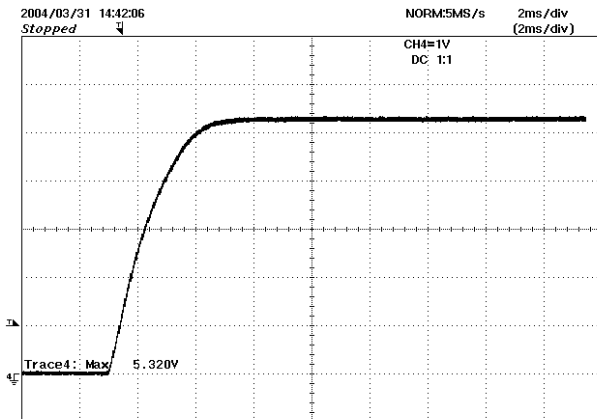

Figure 15 - Start-up Profile, 115VAC
1 V, 2 ms / div.

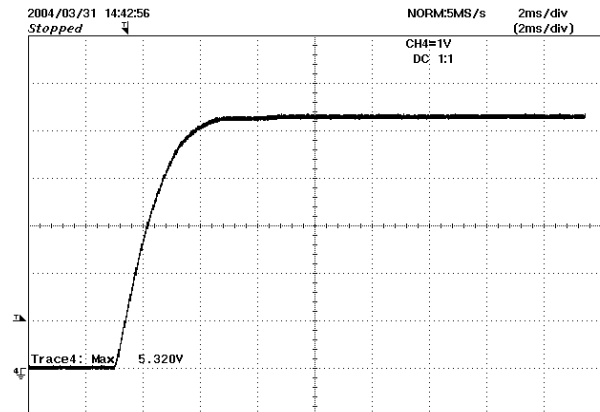

Figure 16 - Start-up Profile, 230 VAC
1 V, 2 ms / div.



10.3 Drain Voltage and Current Start-up Profile

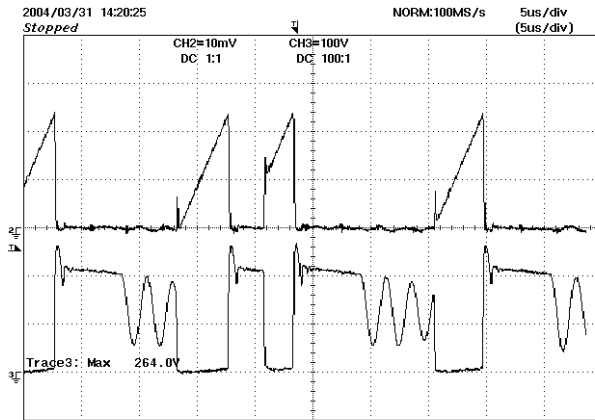

Figure 17 - 90 VAC Input and Maximum Load.
 Upper: I_{DRAIN} , 0.1 A / div.
 Lower: V_{DRAIN} , 100 V & 5us / div.

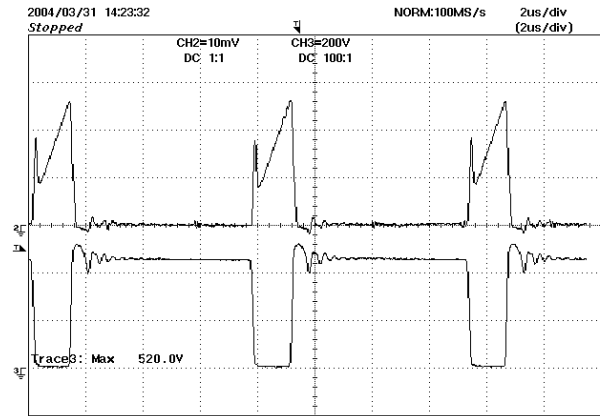

Figure 18 - 264 VAC Input and Maximum Load.
 Upper: I_{DRAIN} , 0.1 A / div.
 Lower: V_{DRAIN} , 200 V & 2us / div.

10.4 Load Transient Response (75% to 100% Load Step)

In the figures shown below, the oscilloscope was triggered using the load current step as a trigger source.

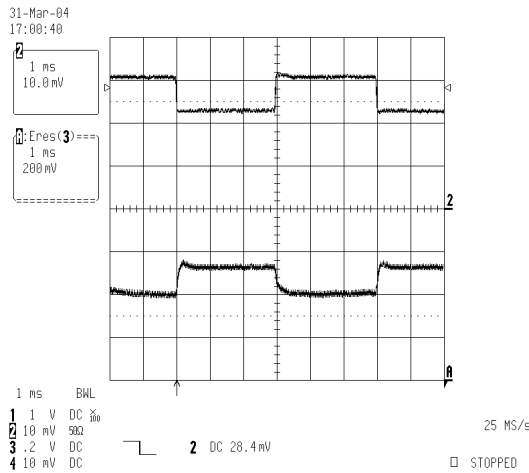

Figure 19 – Transient Response, 115 VAC, 75-100-75% Load Step.
 Top: Load Current, 0.2 A/div.
 Bottom: Output Voltage 200 mV, 1ms / div.

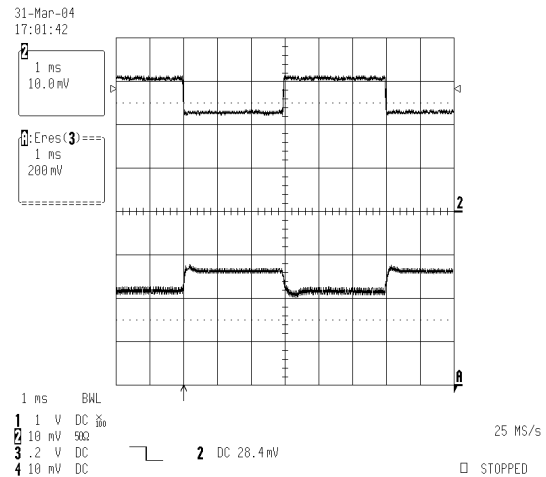

Figure 20 – Transient Response, 230 VAC, 75-100-75% Load Step
 Upper: Load Current, 0.2 A / div.
 Bottom: Output Voltage 200mV, 1ms / div.



10.5 Out put Ripple Measurements

10.5.1 Ripple Measurement Technique

For DC output ripple measurements, a modified oscilloscope test probe must be utilized in order to reduce spurious signals due to pickup. Details of the probe modification are provided in Figure 21 and Figure 22.

The 5125BA probe adapter is affixed with two capacitors tied in parallel across the probe tip. The capacitors include one (1) 0.1 $\mu\text{F}/50\text{ V}$ ceramic type and one (1) 10.0 $\mu\text{F}/50\text{ V}$ aluminum electrolytic. **The aluminum electrolytic type capacitor is polarized, so proper polarity across DC outputs must be maintained (see below).**

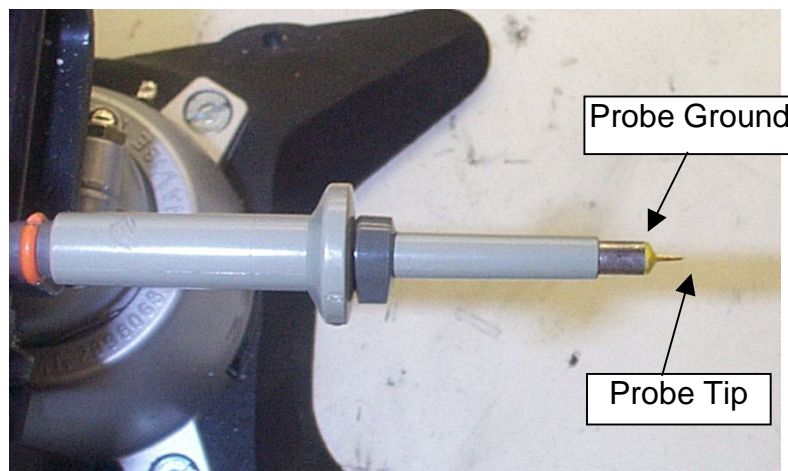

Figure 21 - Oscilloscope Probe Prepared for Ripple Measurement. (End Cap and Ground Lead Removed)

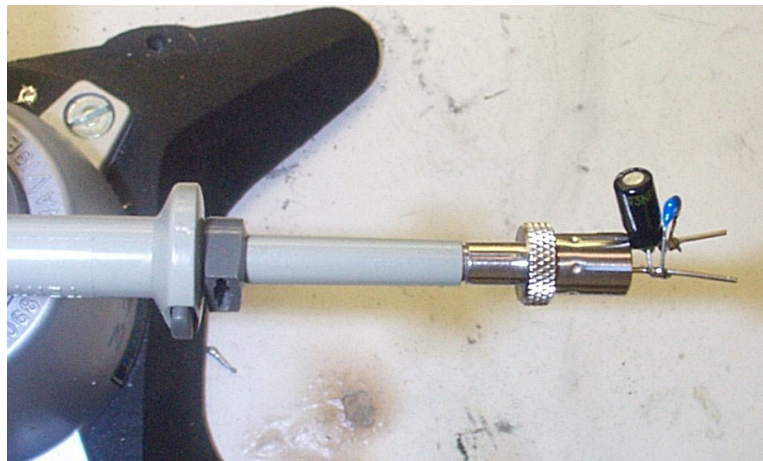

Figure 22 - Oscilloscope Probe with Probe Master 5125BA BNC Adapter. (Modified with wires for probe ground for ripple measurement, and two parallel decoupling capacitors added)

10.5.2 Measurement Results

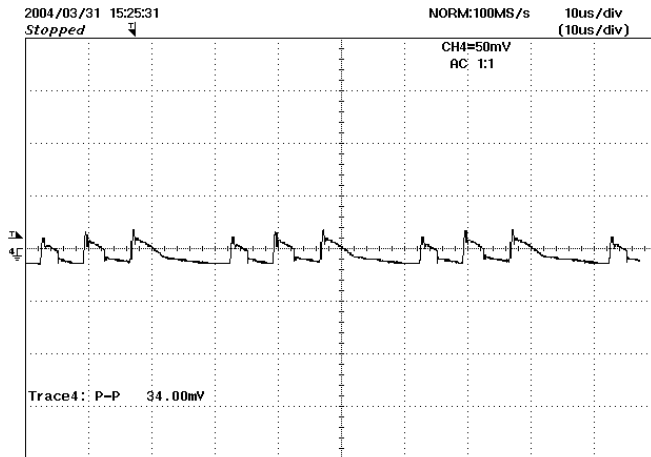

Figure 23 – Output Ripple, 85 VAC, Full Load.
10us, 50 mV / div

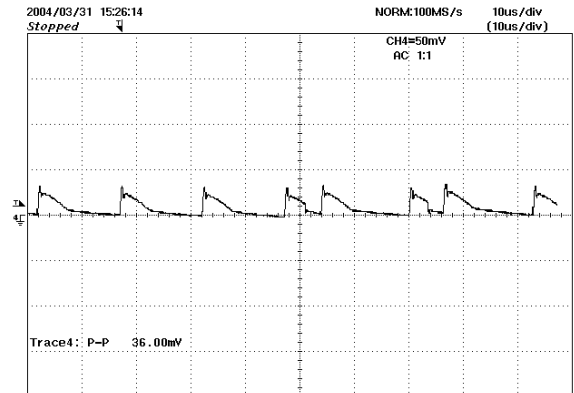

Figure 24 - Output Ripple, 115 VAC, Full Load.
10us, 50 mV / div

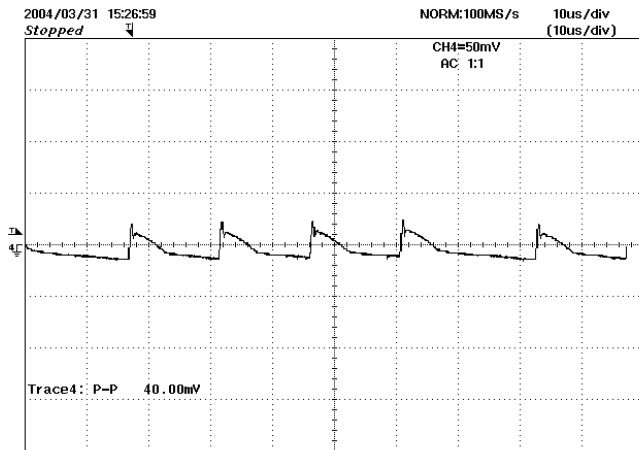

Figure 25 – Output Ripple, 230 VAC, Full Load.
10us, 50 mV /div



11 Conducted EMI

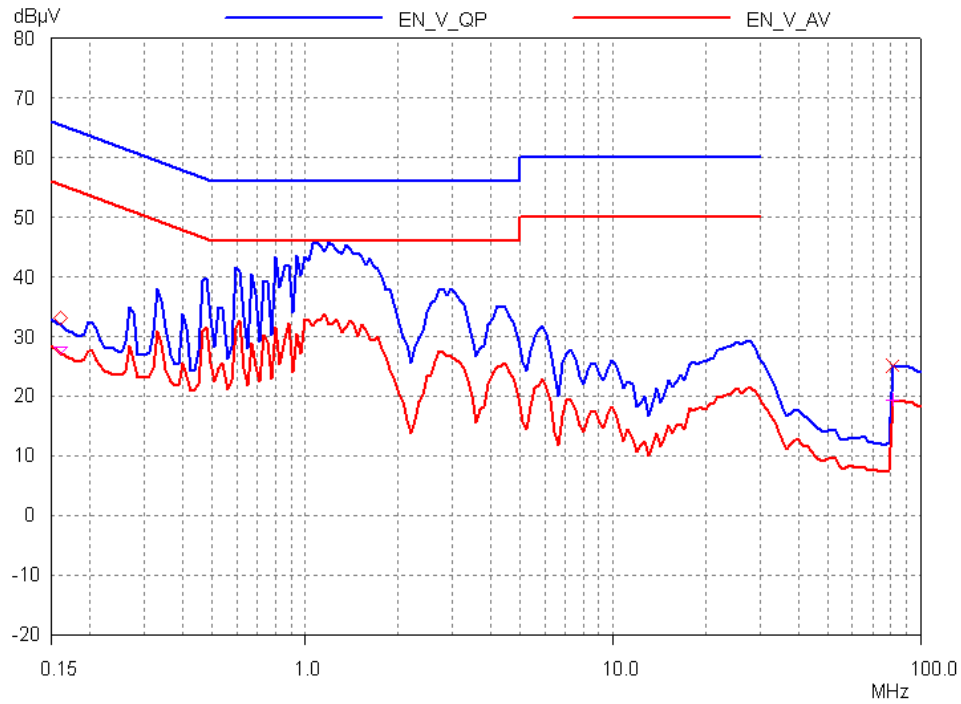

Figure 26 - Conducted EMI, Maximum Steady State Load, 115 VAC, 60 Hz, and EN55022 B Limits.

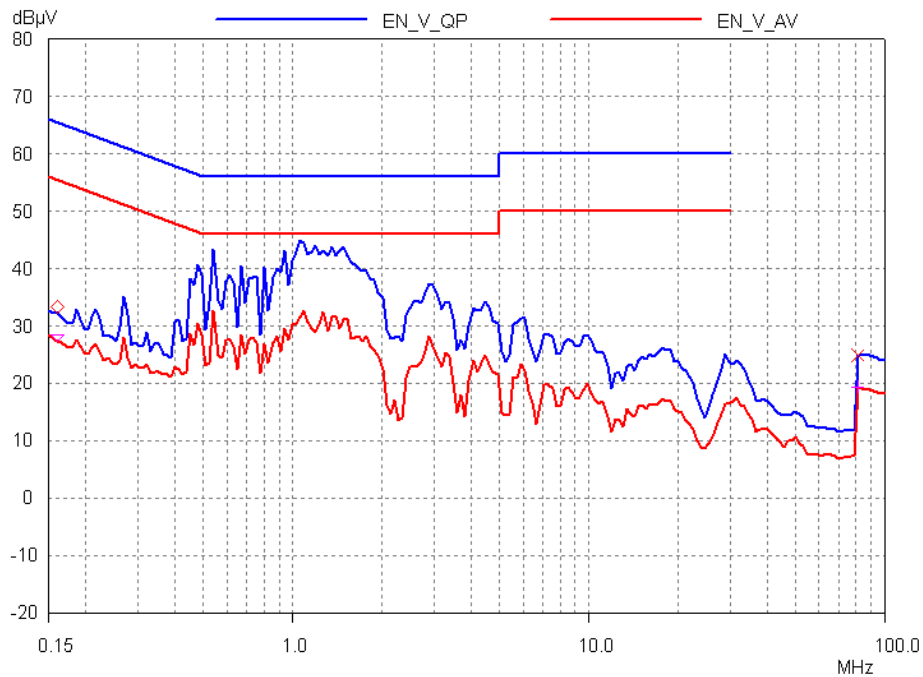

Figure 27 - Conducted EMI, Maximum Steady State Load, 230 VAC, 60 Hz, and EN55022 B Limits.



12 Revision History

Date	Author	Revision	Description & changes	Reviewed
April 5, 2004	VC	1.0	Initial release	AM / VC



For the latest updates, visit our Web site: www.powerint.com

Power Integrations may make changes to its products at any time. Power Integrations has no liability arising from your use of any information, device or circuit described herein nor does it convey any license under its patent rights or the rights of others. POWER INTEGRATIONS MAKES NO WARRANTIES HEREIN AND SPECIFICALLY DISCLAIMS ALL WARRANTIES INCLUDING, WITHOUT LIMITATION, THE IMPLIED WARRANTIES OF MERCHANTABILITY, FITNESS FOR A PARTICULAR PURPOSE, AND NON-INFRINGEMENT OF THIRD PARTY RIGHTS.

PATENT INFORMATION

The products and applications illustrated herein (including circuits external to the products and transformer construction) may be covered by one or more U.S. and foreign patents or potentially by pending U.S. and foreign patent applications assigned to Power Integrations. A complete list of Power Integrations' patents may be found at www.powerint.com.

The PI Logo, **TOPSwitch**, **TinySwitch**, **LinkSwitch**, and **EcoSmart** are registered trademarks of Power Integrations. **PI Expert** and **DPA-Switch** are trademarks of Power Integrations.
© Copyright 2004, Power Integrations.

WORLD HEADQUARTERS

Power Integrations
5245 Hellyer Avenue,
San Jose, CA 95138, USA
Main: +1-408-414-9200
Customer Service:
Phone: +1-408-414-9665
Fax: +1-408-414-9765
e-mail:
usasales@powerint.com

AMERICAS

Power Integrations, Inc.
4335 South Lee Street,
Suite G,
Buford, GA 30518, USA
Phone: +1-678-714-6033
Fax: +1-678-714-6012
e-mail:
usasales@powerint.com

CHINA (SHANGHAI)

Power Integrations
International Holdings, Inc.
Rm 807, Pacheer,
Commercial Centre,
555 Nanjing West Road,
Shanghai, 200041, China
Phone: +86-21-6215-5548
Fax: +86-21-6215-2468
e-mail:
chinasales@powerint.com

APPLICATIONS HOTLINE

World Wide +1-408-414-9660

CHINA (SHENZHEN)

Power Integrations
International Holdings, Inc.
Rm# 1705, Bao Hua Bldg.
1016 Hua Qiang Bei Lu,
Shenzhen, Guangdong,
518031, China
Phone: +86-755-8367-5143
Fax: +86-755-8377-9610
e-mail: chinasales@powerint.com

GERMANY

Power Integrations, GmbH
Rueckertstrasse 3,
D-80336, Munich, Germany
Phone: +49-895-527-3910
Fax: +49-895-527-3920
e-mail: eurosales@powerint.com

INDIA (TECHNICAL SUPPORT)

Innovatech
261/A, Ground Floor
7th Main, 17th Cross,
Sadashivanagar
Bangalore, India, 560080
Phone: +91-80-5113-8020
Fax: +91-80-5113-8023
e-mail: indiasales@powerint.com

APPLICATIONS FAX

World Wide +1-408-414-9760

ITALY

Power Integrations s.r.l.
Via Vittorio Veneto 12,
Bresso, Milano,
20091, Italy
Phone: +39-028-928-6001
Fax: +39-028-928-6009
e-mail:
eurosales@powerint.com

JAPAN

Power Integrations, K.K.
Keihin-Tatemono 1st Bldg.
12-20 Shin-Yokohama,
2-Chome,
Kohoku-ku, Yokohama-shi,
Kanagawa 222-0033, Japan
Phone: +81-45-471-1021
Fax: +81-45-471-3717
e-mail:
japansales@powerint.com

KOREA

Power Integrations
International Holdings, Inc.
8th Floor, DongSung Bldg.
17-8 Yoido-dong,
Youngdeungpo-gu,
Seoul, 150-874, Korea
Phone: +82-2-782-2840
Fax: +82-2-782-4427
e-mail:
koreasales@powerint.com

SINGAPORE (ASIA PACIFIC HEADQUARTERS)

Power Integrations, Singapore
51 Newton Road,
#15-08/10 Goldhill Plaza,
Singapore, 308900
Phone: +65-6358-2160
Fax: +65-6358-2015
e-mail:
singaporesales@powerint.com

TAIWAN

Power Integrations
International Holdings, Inc.
17F-3, No. 510,
Chung Hsiao E. Rd., Sec. 5,
Taipei, Taiwan 110, R.O.C.
Phone: +886-2-2727-1221
Fax: +886-2-2727-1223
e-mail:
taiwansales@powerint.com

UK (EUROPE & AFRICA HEADQUARTERS)

1st Floor, St. James's House
East Street
Farnham, Surrey GU9 7TJ
United Kingdom
Phone: +44-1252-730-140
Fax: +44-1252-727-689
e-mail: eurosales@powerint.com

ER or EPR template – Rev 3.4 – Single sided

