

TURBO 2 ULTRAFAST HIGH VOLTAGE RECTIFIER
Table 1: Main Product Characteristics

$I_{F(AV)}$	5 A
V_{RRM}	600 V
T_j	175°C
V_F (typ)	1.4 V
t_{rr} (max)	40 ns

FEATURES AND BENEFITS

- Ultrafast switching
- Low reverse recovery current
- Low thermal resistance
- Reduces switching losses

DESCRIPTION

The STTH5R06, which is using ST Turbo 2 600V technology, is specially suited as boost diode in continuous mode power factor corrections and hard switching conditions. This device is also intended for use as a free wheeling diode in power supplies and other power switching applications.

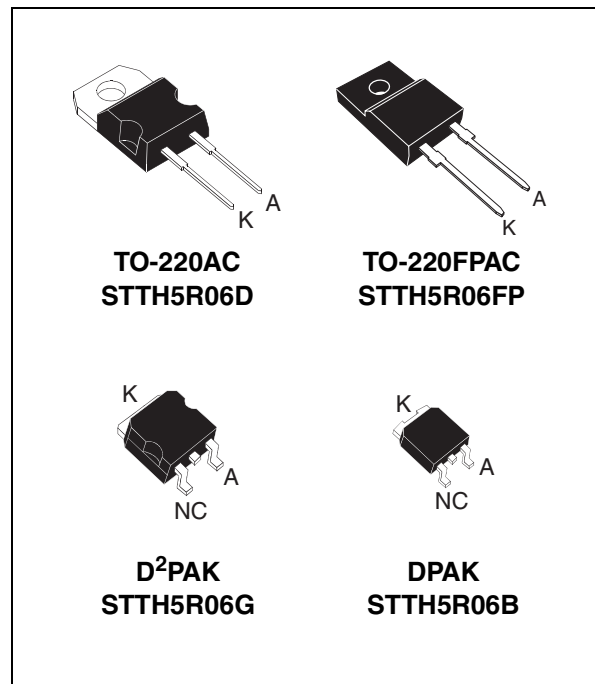
Table 2: Order Codes

Part Number	Marking
STTH5R06D	STTH5R06D
STTH5R06FP	STTH5R06FP
STTH5R06B	STTH5R06B

Part Number	Marking
STTH5R06B-TR	STTH5R06B
STTH5R06G	STTH5R06G
STTH5R06G-TR	STTH5R06G

Table 3: Absolute Ratings (limiting values)

Symbol	Parameter		Value	Unit	
V_{RRM}	Repetitive peak reverse voltage		600	V	
$I_{F(RMS)}$	RMS forward current	TO-220AC / TO-220FPAC / D ² PAK	20	A	
		DPAK	10		
$I_{F(AV)}$	Average forward current	TO-220AC / DPAK / D ² PAK	$T_c = 135^\circ\text{C} \quad \delta = 0.5$	A	
		TO-220FPAC	$T_c = 105^\circ\text{C} \quad \delta = 0.5$		
I_{FSM}	Surge non repetitive forward current		$t_p = 10\text{ms sinusoidal}$	50	A
T_{stg}	Storage temperature range		-65 to + 175	°C	
T_j	Maximum operating junction temperature		175	°C	

Table 4: Thermal Resistance

Symbol	Parameter		Value (max).	Unit
R _{th(j-c)}	Junction to case	TO-220AC / DPA / D ² PAK	3.0	°C/W
		TO-220FPAC	5.5	

Table 5: Static Electrical Characteristics

Symbol	Parameter	Test conditions		Min.	Typ	Max.	Unit
I _R *	Reverse leakage current	T _j = 25°C	V _R = V _{RRM}			20	µA
		T _j = 125°C			25	250	
V _F **	Forward voltage drop	T _j = 25°C	I _F = 5A			2.9	V
		T _j = 125°C			1.4	1.8	

Pulse test: * tp = 5 ms, δ < 2%

** tp = 380 µs, δ < 2%

To evaluate the conduction losses use the following equation: $P = 1.164 \times I_{F(AV)} + 0.128 I_F^2 (RMS)$

Table 6: Dynamic Characteristics

Symbol	Parameter	Test conditions		Min.	Typ	Max.	Unit
t _{rr}	Reverse recovery time	T _j = 25°C	I _F = 0.5A I _{rr} = 0.25A I _R = 1A			25	ns
			I _F = 1A di _F /dt = -50 A/µs V _R = 30V			40	
I _{RM}	Reverse recovery current	T _j = 125°C	I _F = 5A V _R = 400V di _F /dt = -200 A/µs		5.0	6.0	A
S factor	Softness factor				0.35		
Q _{rr}	Reverse recovery charges				110		nC
t _{fr}	Forward recovery time	T _j = 25°C	I _F = 5A di _F /dt = 40 A/µs V _{FR} = 1.1 x V _{Fmax}			150	ns
V _{FP}	Forward recovery voltage	T _j = 25°C	I _F = 5A di _F /dt = 40 A/µs V _{FR} = 1.1 x V _{Fmax}			4.5	V

Figure 1: Conduction losses versus average current

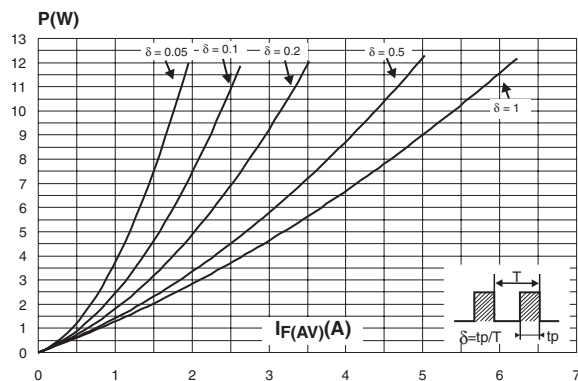

Figure 2: Forward voltage drop versus forward current

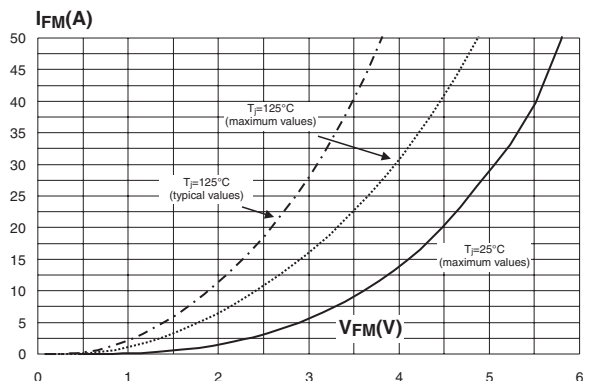

Figure 3: Relative variation of thermal impedance junction to case versus pulse duration (TO-220AC, DPAK, D²PAK)

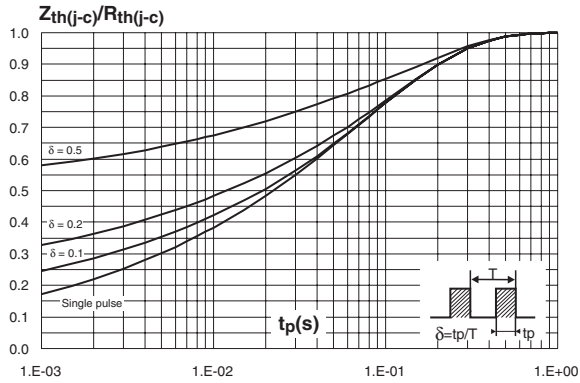

Figure 4: Relative variation of thermal impedance junction to case versus pulse duration (TO-220FPAC)

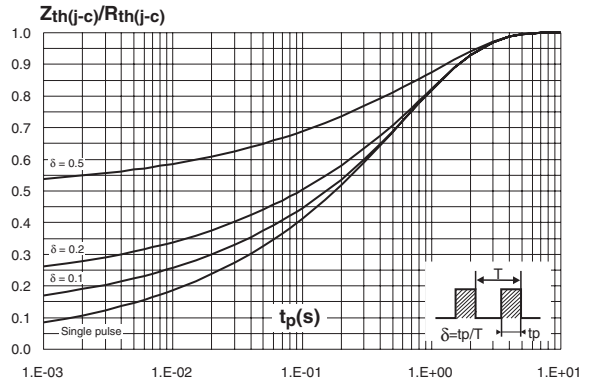

Figure 5: Peak reverse recovery current versus di_F/dt (90% confidence)

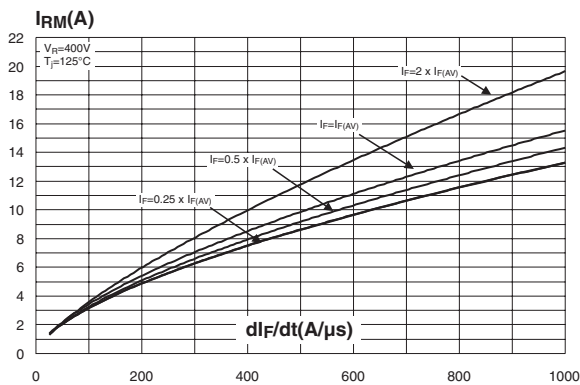

Figure 6: Reverse recovery time versus di_F/dt (90% confidence)

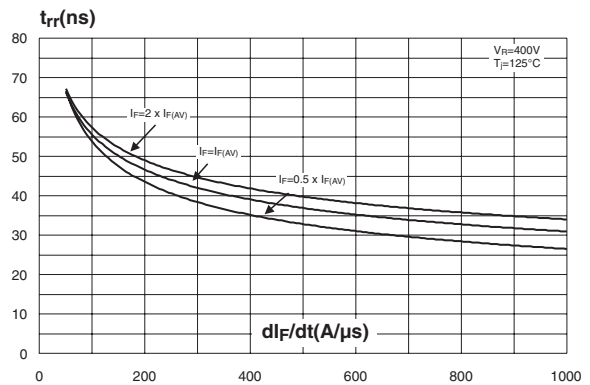

Figure 7: Reverse recovery charges versus di_F/dt (90% confidence)

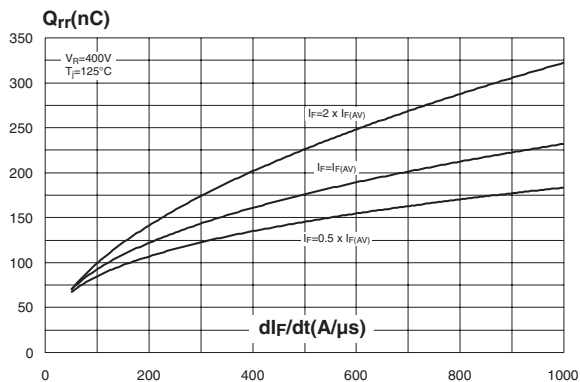

Figure 8: Softness factor versus di_F/dt (typical values)

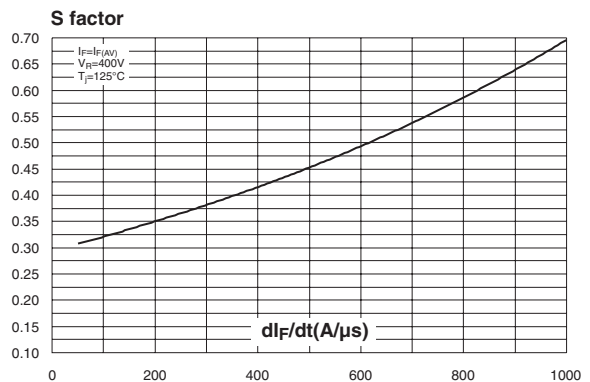

Figure 9: Relative variations of dynamic parameters versus junction temperature

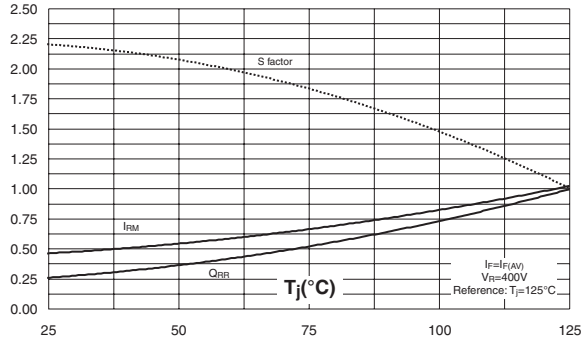

Figure 10: Transient peak forward voltage versus di_F/dt (90% confidence)

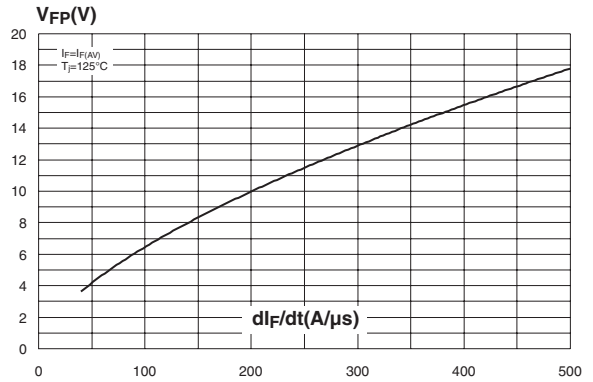

Figure 11: Forward recovery time versus di_F/dt (90% confidence)

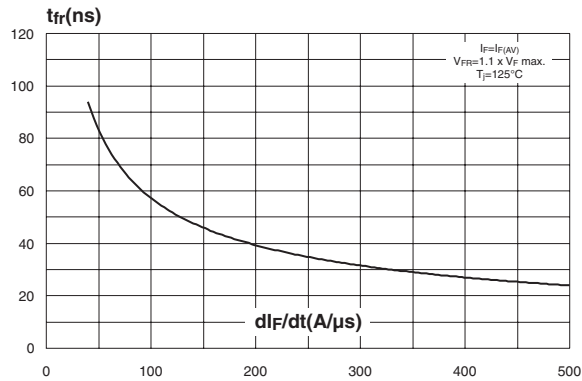

Figure 12: Junction capacitance versus reverse voltage applied (typical values)

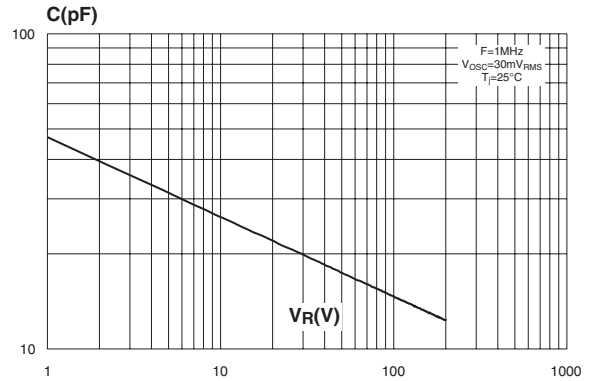

Figure 13: Thermal resistance junction to ambient versus copper surface under tab (epoxy FR4, $e_{CU} = 35\mu\text{m}$) (DPAK and D²PAK)

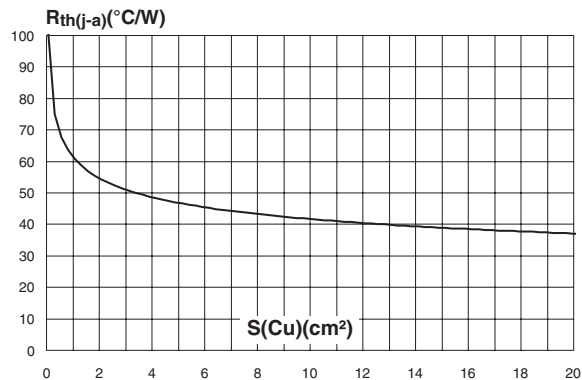

Figure 14: DPAK Package Mechanical Data

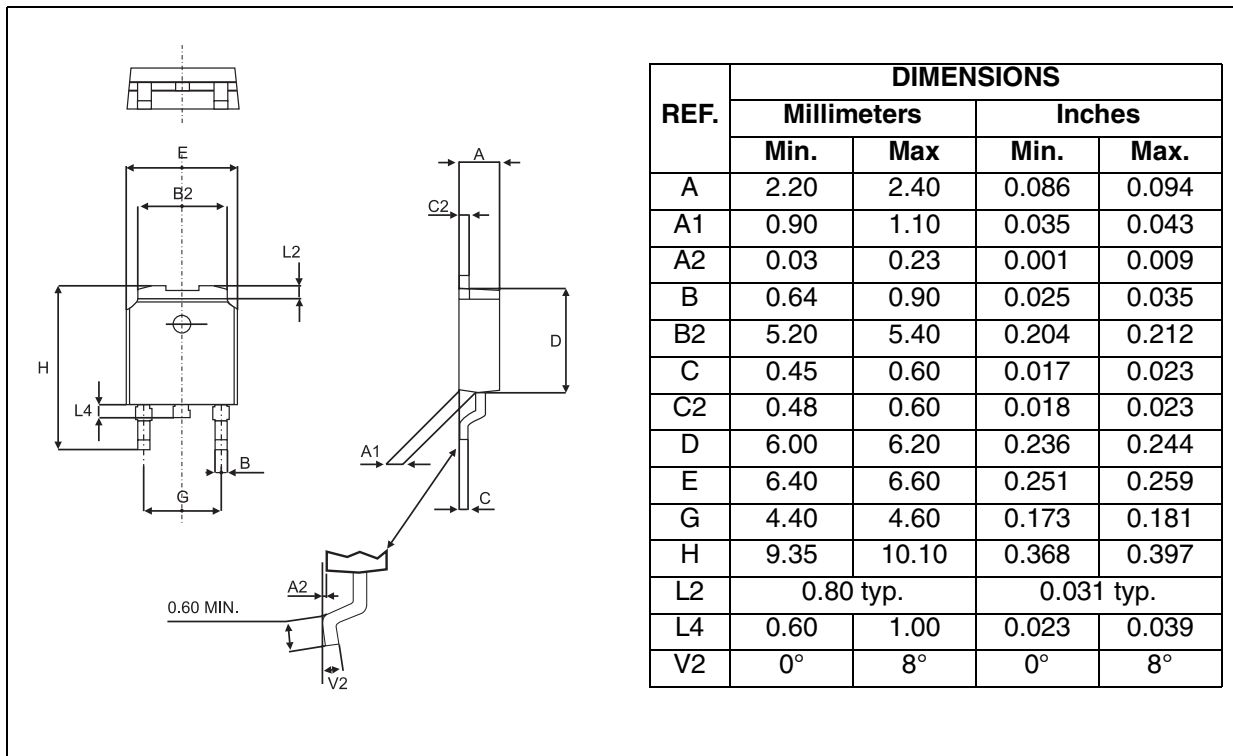

Figure 15: DPAK Foot Print Dimensions (in millimeters)

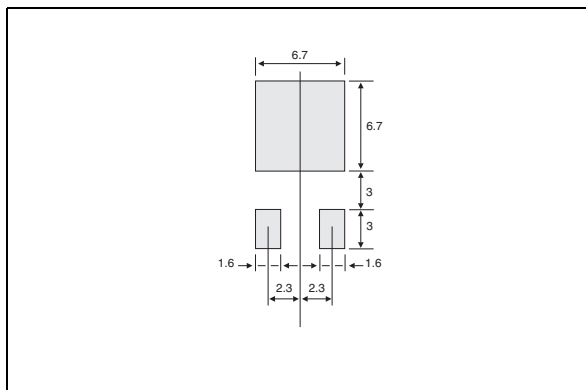

Figure 16: D²PAK Package Mechanical Data

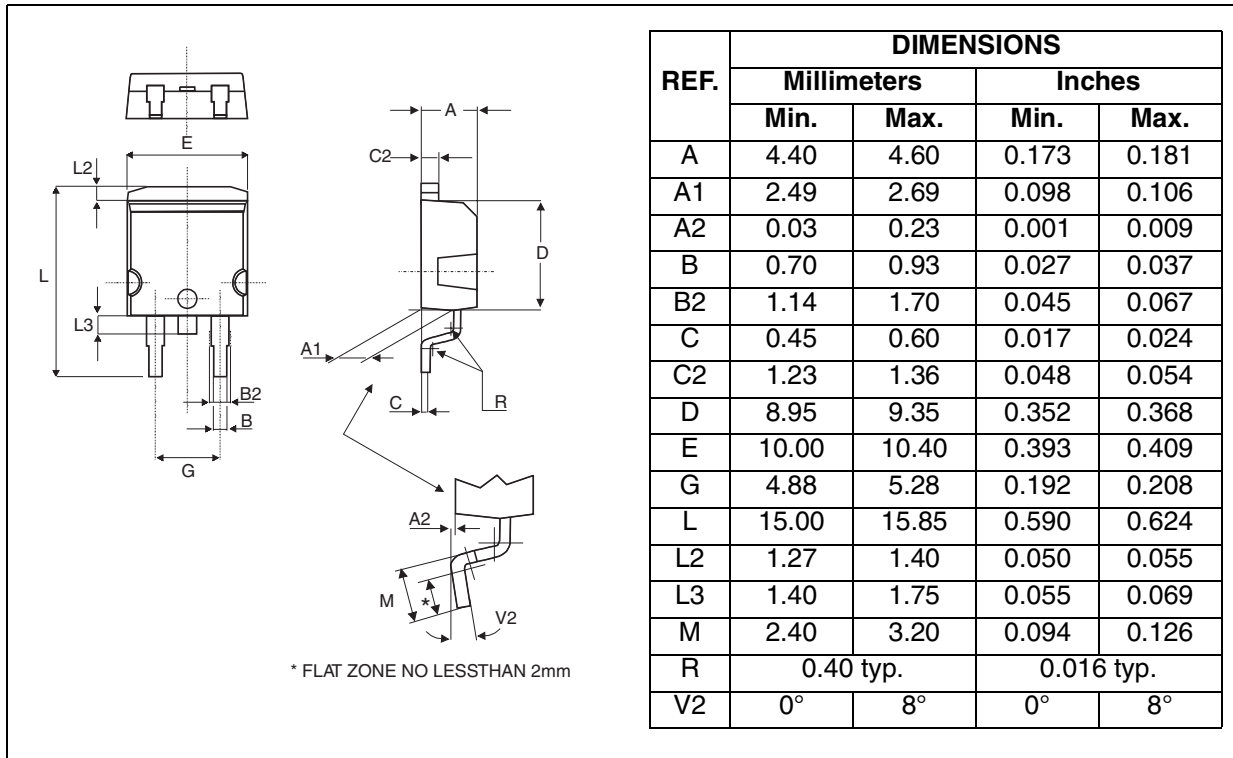

Figure 17: D²PAK Foot Print Dimensions (in millimeters)

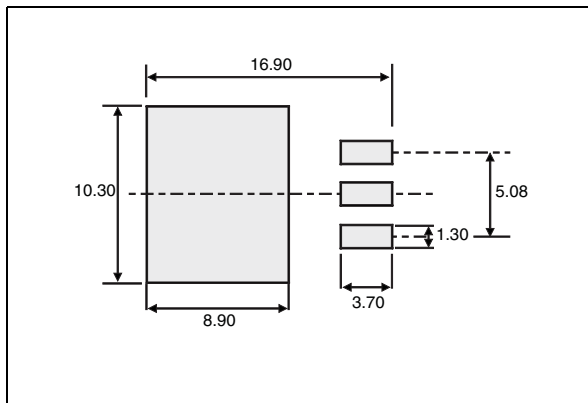

Figure 18: TO-220FPAC Package Mechanical Data

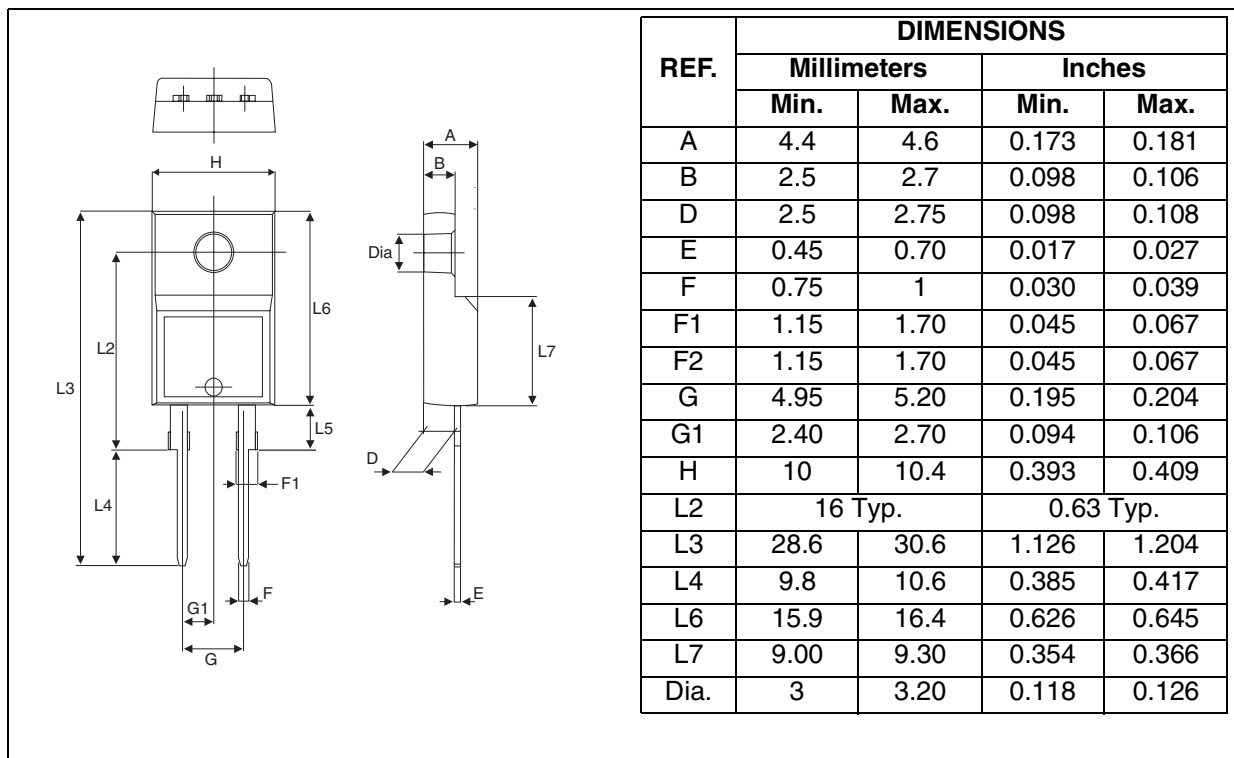
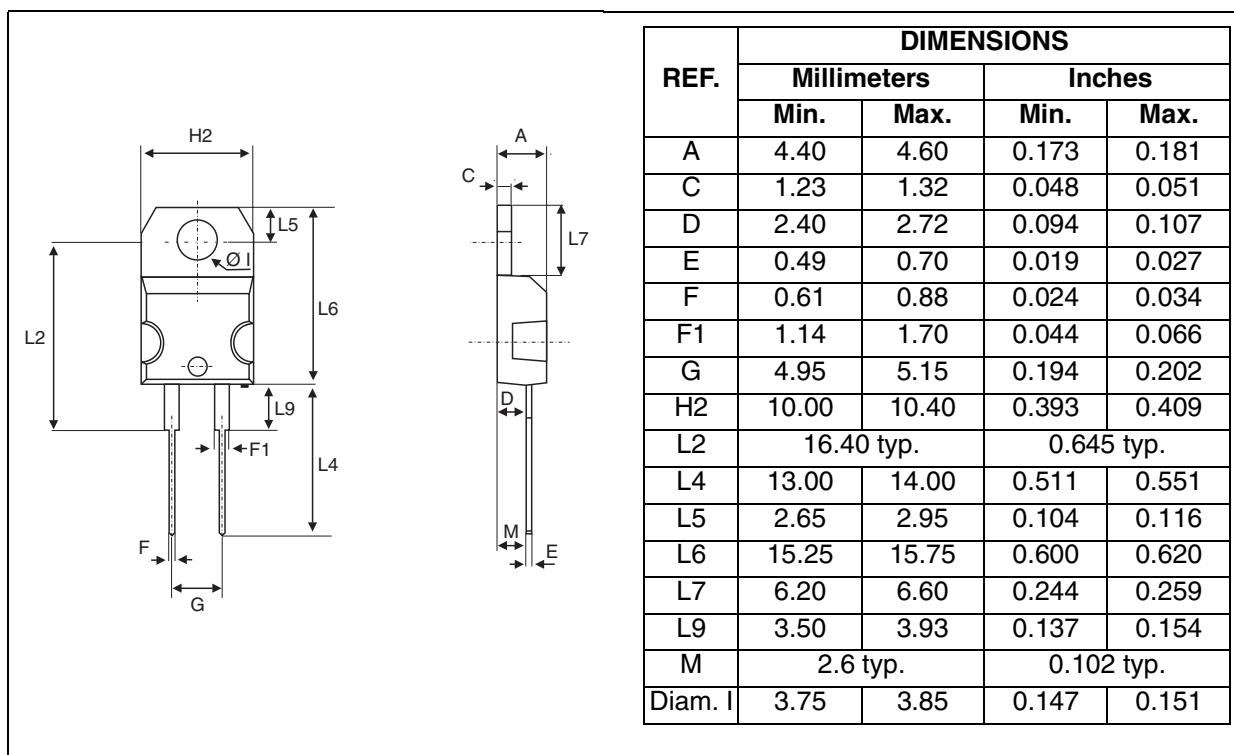

Figure 19: TO-220AC Package Mechanical Data



STTH5R06

Table 7: Ordering Information

Ordering type	Marking	Package	Weight	Base qty	Delivery mode
STTH5R06D	STTH5R06D	TO-220AC	1.90 g	50	Tube
STTHR5R06G	STTH5R06G	D ² PAK	1.48 g	50	Tube
STTHR5R06G-TR	STTHR5R06G	D ² PAK	1.48 g	1000	Tape & reel
STTHR5R06FP	STTHR5R06FP	TO-220FPAC	1.70 g	50	Tube
STTHR5R06B	STTHR5R06B	DPAK	0.3 g	75	Tube
STTHR5R06B-TR	STTHR5R06B-TR	DPAK	0.3 g	2500	Tape & reel

- Epoxy meets UL94, V0
- Cooling method: by conduction (C)
- Recommended torque value: 0.8 m.N. (TO-220FPAC) / 0.55 m.N. (TO-220AC)
- Maximum torque value: 1.0 m.N. (TO-220FPAC) / 0.70 m.N. (TO-220AC)

Table 8: Revision History

Date	Revision	Description of Changes
Oct-2002	3	Last update
07-Sep-2004	4	Tcases values splitted for TO-220FPAC package

Information furnished is believed to be accurate and reliable. However, STMicroelectronics assumes no responsibility for the consequences of use of such information nor for any infringement of patents or other rights of third parties which may result from its use. No license is granted by implication or otherwise under any patent or patent rights of STMicroelectronics. Specifications mentioned in this publication are subject to change without notice. This publication supersedes and replaces all information previously supplied. STMicroelectronics products are not authorized for use as critical components in life support devices or systems without express written approval of STMicroelectronics.

The ST logo is a registered trademark of STMicroelectronics.
All other names are the property of their respective owners

© 2004 STMicroelectronics - All rights reserved

STMicroelectronics group of companies

Australia - Belgium - Brazil - Canada - China - Czech Republic - Finland - France - Germany - Hong Kong - India - Israel - Italy - Japan -
Malaysia - Malta - Morocco - Singapore - Spain - Sweden - Switzerland - United Kingdom - United States of America

www.st.com

