

TURBO 2 ULTRAFAST HIGH VOLTAGE RECTIFIER

Table 1: Main Product Characteristics

$I_{F(AV)}$	12 A
V_{RRM}	600 V
I_{RM} (typ)	7 A
T_j	175°C
V_F (typ)	1.4 V
t_{rr} (max)	25 ns

FEATURES AND BENEFITS

- Ultrafast switching
- Low reverse recovery current
- Low thermal resistance
- Reduces switching losses

DESCRIPTION

The STTH12R06, which is using ST Turbo 2 600V technology, is specially suited as boost diode in continuous mode power factor corrections and hard switching conditions.

This device is also intended for use as a free wheeling diode in power supplies and other power switching applications.

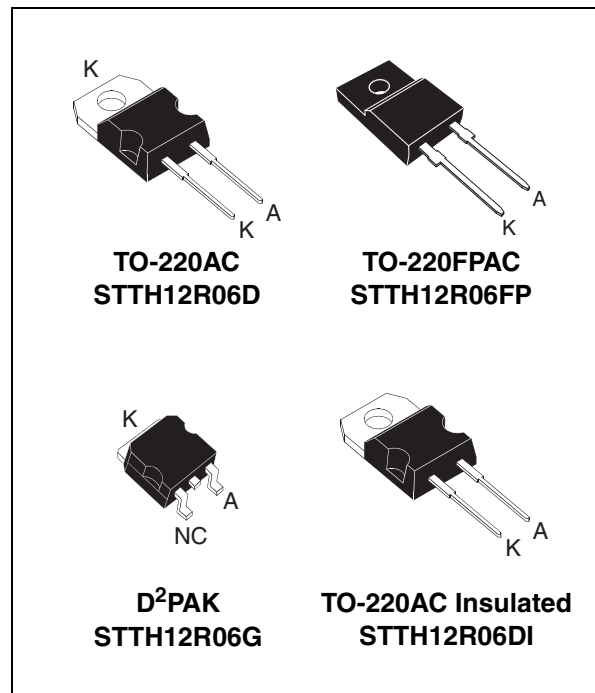

Table 2: Order Codes

Part Number	Marking
STTH12R06D	STTH12R06D
STTH12R06FP	STTH12R06FP
STTH12R06G	STTH12R06G
STTH12R06G-TR	STTH12R06G
STTH12R06DI	STTH12R06DI
STTH12R06DIRG	STTH12R06DI

STTH12R06

Table 3: Absolute Ratings (limiting values)

Symbol	Parameter		Value	Unit	
V_{RRM}	Repetitive peak reverse voltage		600	V	
$I_{F(RMS)}$	RMS forward voltage	TO-220AC / TO-220FPAC / D ² PAK	30	A	
		TO-220AC Ins.	24		
$I_{F(AV)}$	Average forward current $\delta = 0.5$	TO-220AC / D ² PAK	12	A	
		TO-220FPAC			$T_c = T_{125^\circ C}$
		TO-220AC Ins.			$T_c = 50^\circ C$
		TO-220AC Ins.	$T_c = 80^\circ C$		
I_{FSM}	Surge non repetitive forward current		tp = 10ms sinusoidal	100	A
T_{stg}	Storage temperature range		-65 to + 175		°C
T_j	Maximum operating junction temperature		175		°C

Table 4: Thermal Resistance

Symbol	Parameter		Value (max).	Unit
$R_{th(j-c)}$	Junction to case	TO-220AC / D ² PAK	1.7	°C/W
		TO-220FPAC	4.4	
		TO-220AC Ins.	3.3	

Table 5: Static Electrical Characteristics

Symbol	Parameter	Test conditions		Min.	Typ	Max.	Unit
I_R	Reverse leakage current	$T_j = 25^\circ C$	$V_R = V_{RRM}$			45	μA
		$T_j = 125^\circ C$			50	600	
V_F	Forward voltage drop	$T_j = 25^\circ C$	$I_F = 12A$			2.9	V
		$T_j = 125^\circ C$			1.4	1.8	

To evaluate the conduction losses use the following equation: $P = 1.16 \times I_{F(AV)} + 0.053 I_{F(RMS)}^2$

Table 6: Dynamic Characteristics

Symbol	Parameter	Test conditions		Min.	Typ	Max.	Unit
t_{rr}	Reverse recovery time	$T_j = 25^\circ C$	$I_F = 0.5A$ $I_{rr} = 0.25A$ $I_R = 1A$			25	ns
			$I_F = 1A$ $di_F/dt = -50 A/\mu s$ $V_R = 30V$			45	
I_{RM}	Reverse recovery current	$T_j = 125^\circ C$	$I_F = 12A$ $V_R = 400V$ $di_F/dt = -200 A/\mu s$		7.0	8.4	A
S factor	Softness factor				0.2		
Qrr	Reverse recovery charges				180		
t_{fr}	Forward recovery time	$T_j = 25^\circ C$	$I_F = 12A$ $di_F/dt = 96 A/\mu s$ $V_{FR} = 1.1 \times V_{Fmax}$			200	ns
V_{FP}	Forward recovery voltage					5.5	V

Figure 1: Conduction losses versus average current

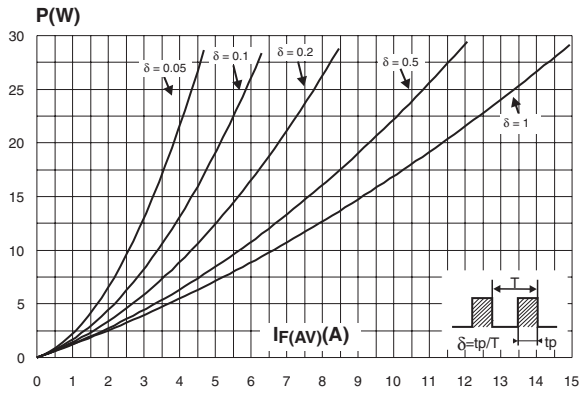

Figure 2: Forward voltage drop versus forward current

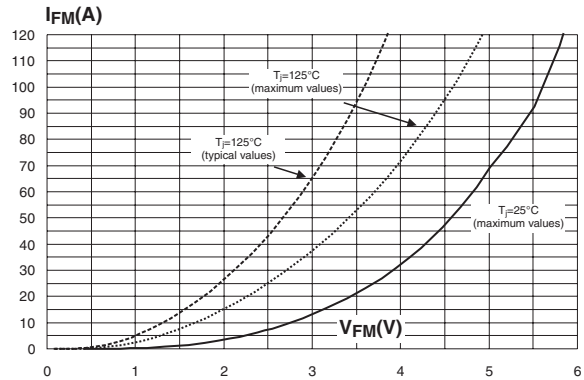

Figure 3: Relative variation of thermal impedance junction to case versus pulse duration (TO-220AC, TO-220AC Ins., D²PAK)

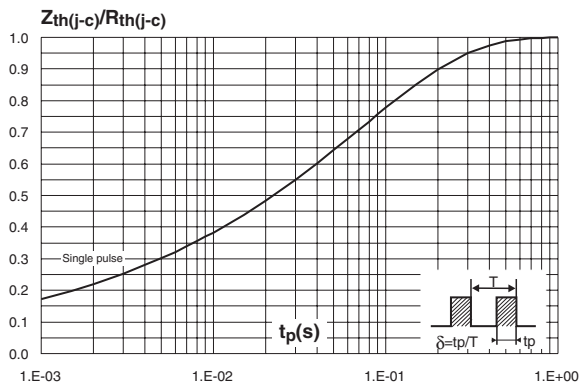

Figure 4: Relative variation of thermal impedance junction to case versus pulse duration (TO-220FPAC)

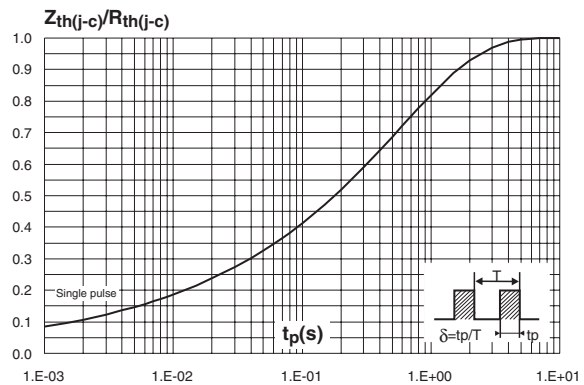

Figure 5: Peak reverse recovery current versus di_F/dt (typical values)

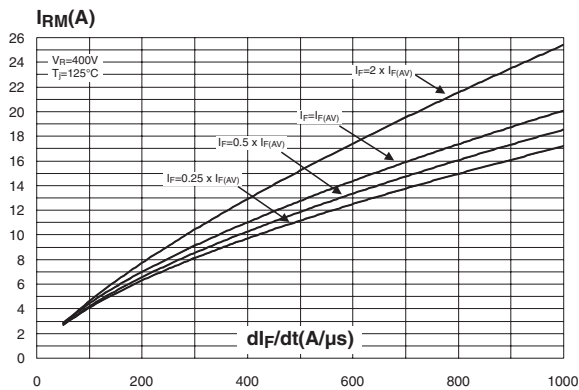

Figure 6: Reverse recovery time versus di_F/dt (typical values)

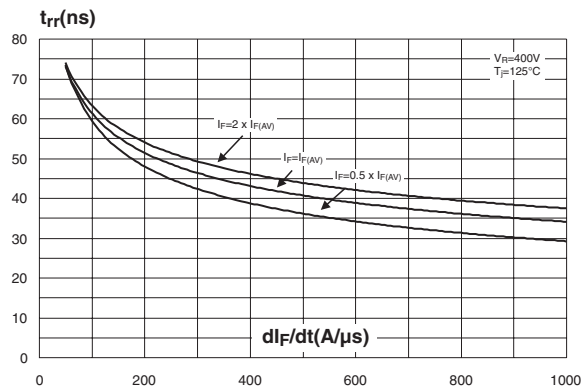

Figure 7: Reverse recovery charges versus di_F/dt (typical values)

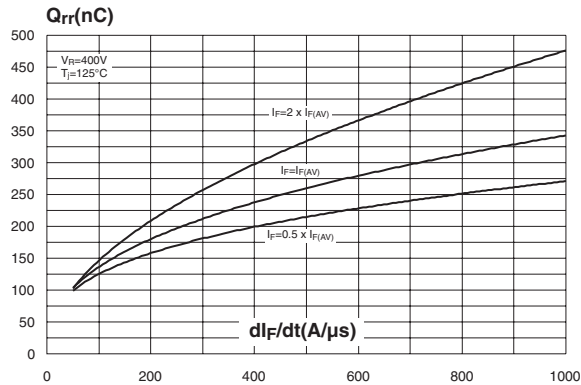

Figure 8: Softness factor versus di_F/dt (typical values)

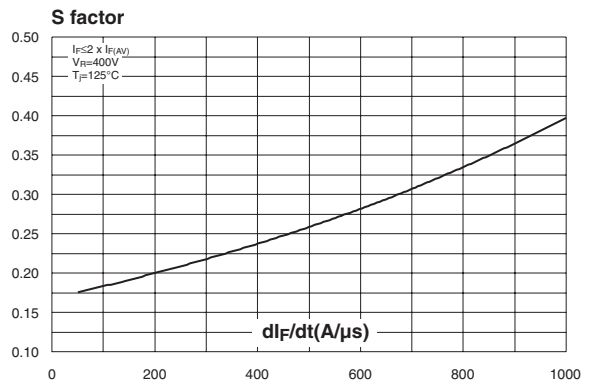

Figure 9: Relative variations of dynamic parameters versus junction temperature

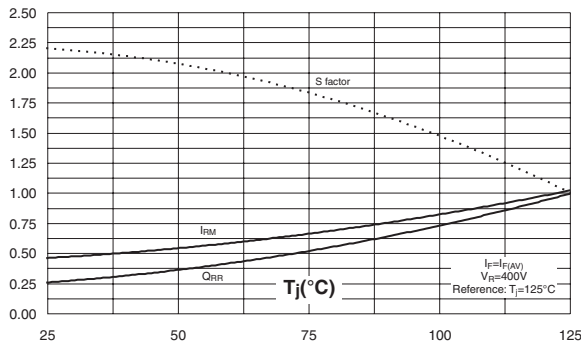

Figure 10: Transient peak forward voltage versus di_F/dt (typical values)

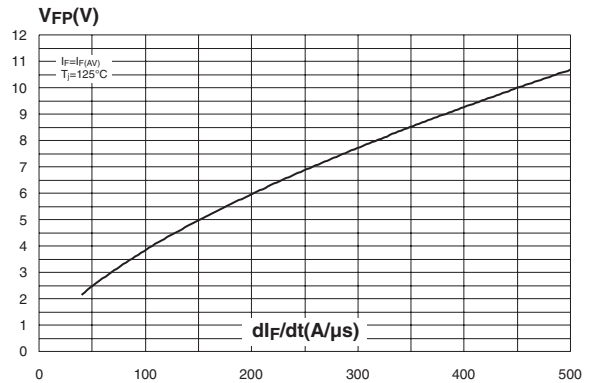

Figure 11: Forward recovery time versus di_F/dt (typical values)

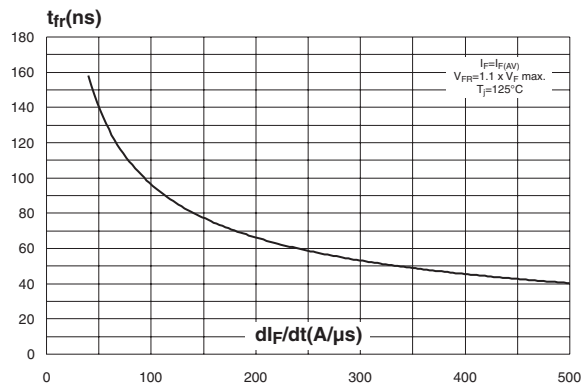

Figure 12: Junction capacitance versus reverse voltage applied (typical values)

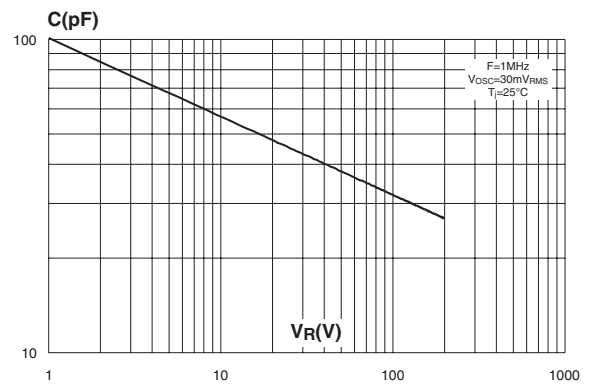

Figure 13: Thermal resistance junction to ambient versus copper surface under tab (epoxy FR4, $e_{Cu}=35\mu m$) (D²PAK)

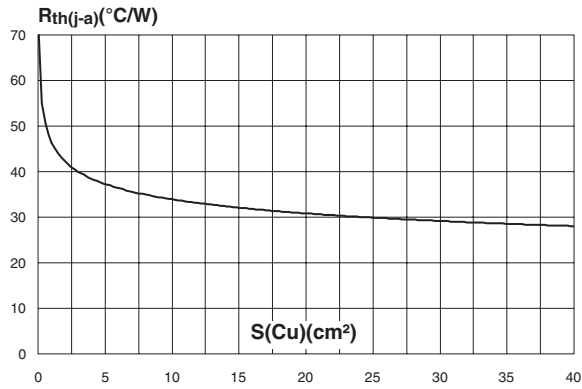

Figure 14: TO-220FPAC Package Mechanical Data

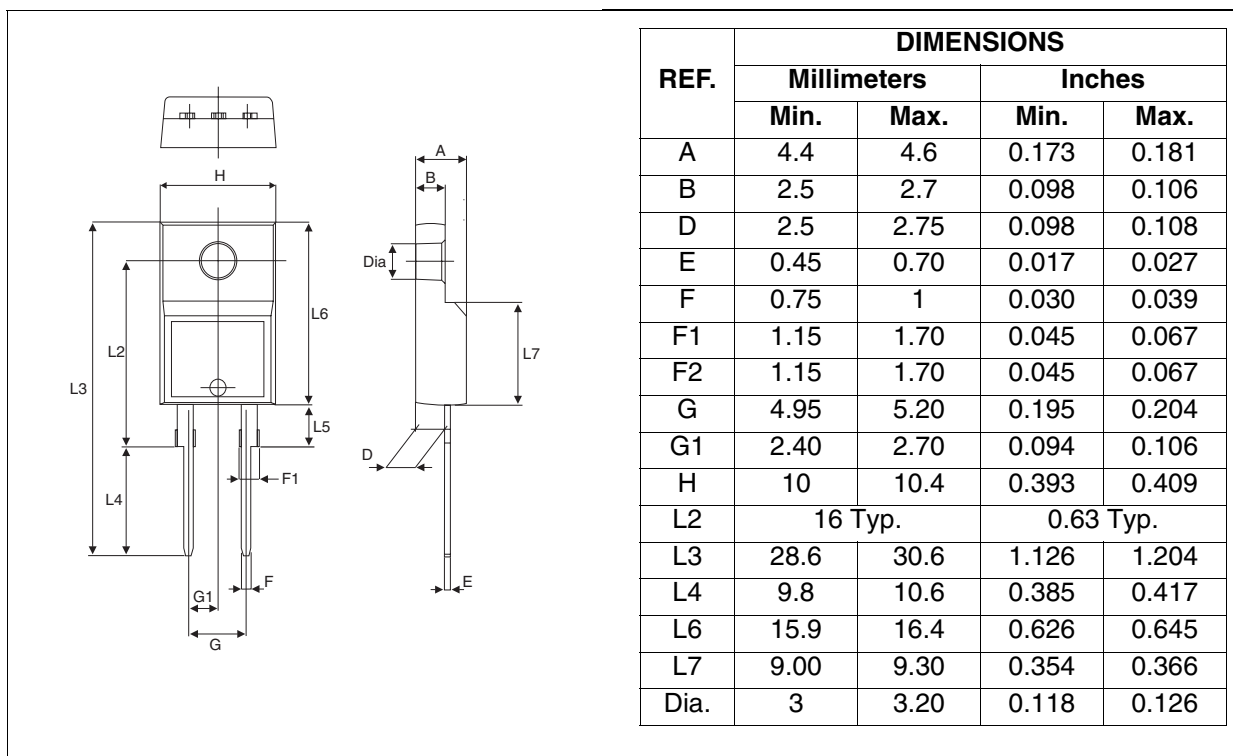

Figure 15: D²PAK Package Mechanical Data

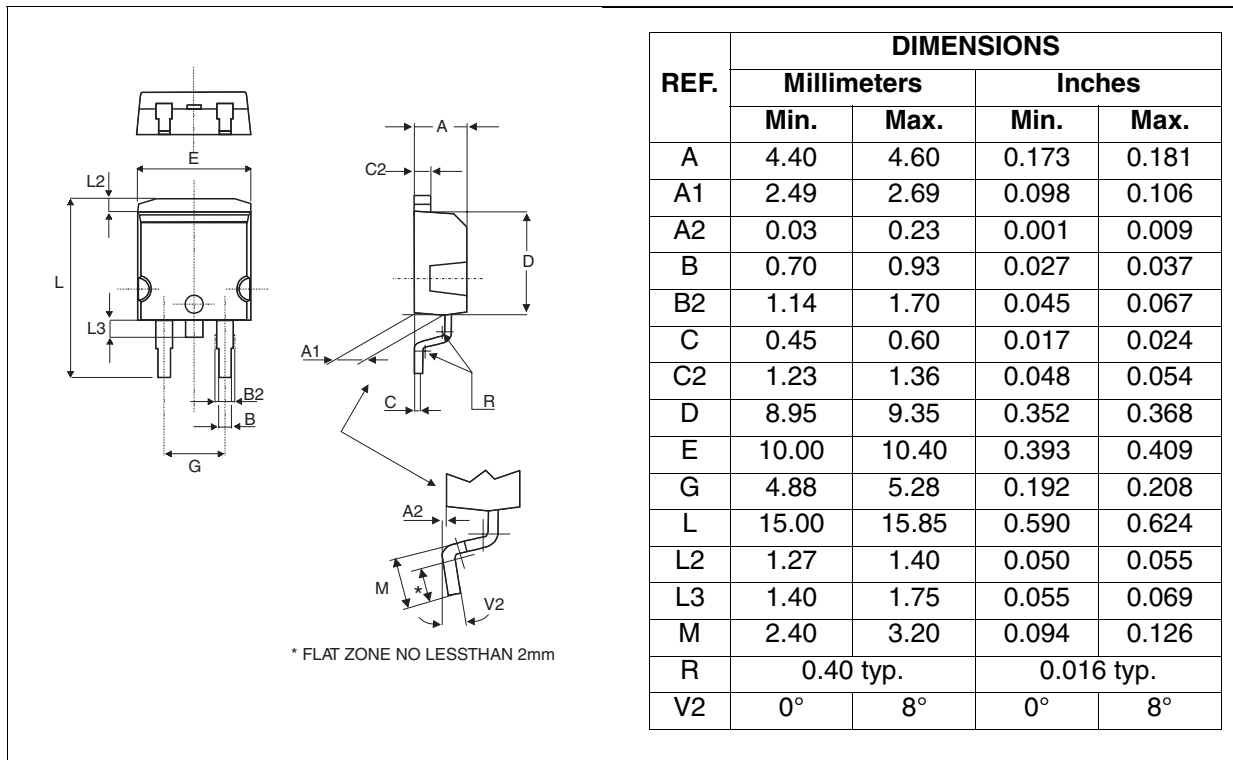

Figure 16: D²PAK Foot Print Dimensions (in millimeters)

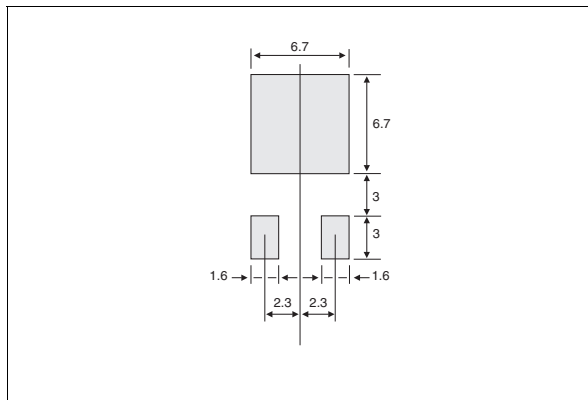

Figure 17: TO-220AC Package Mechanical Data

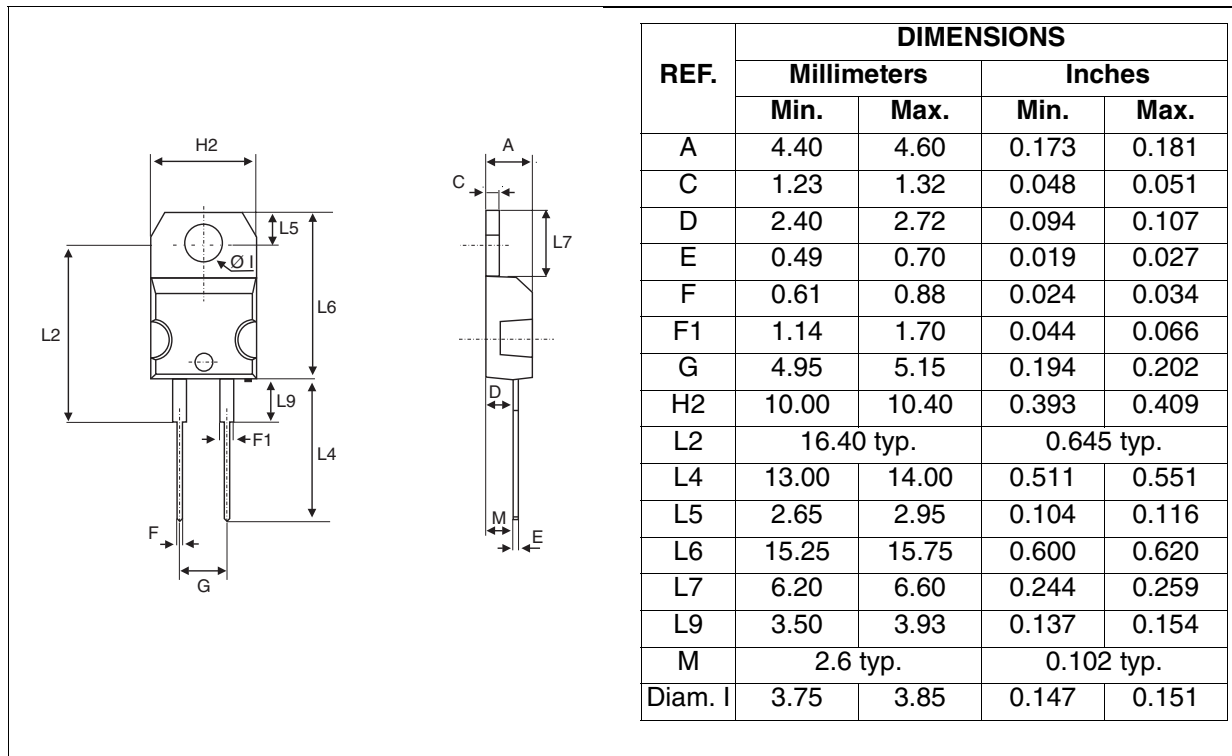
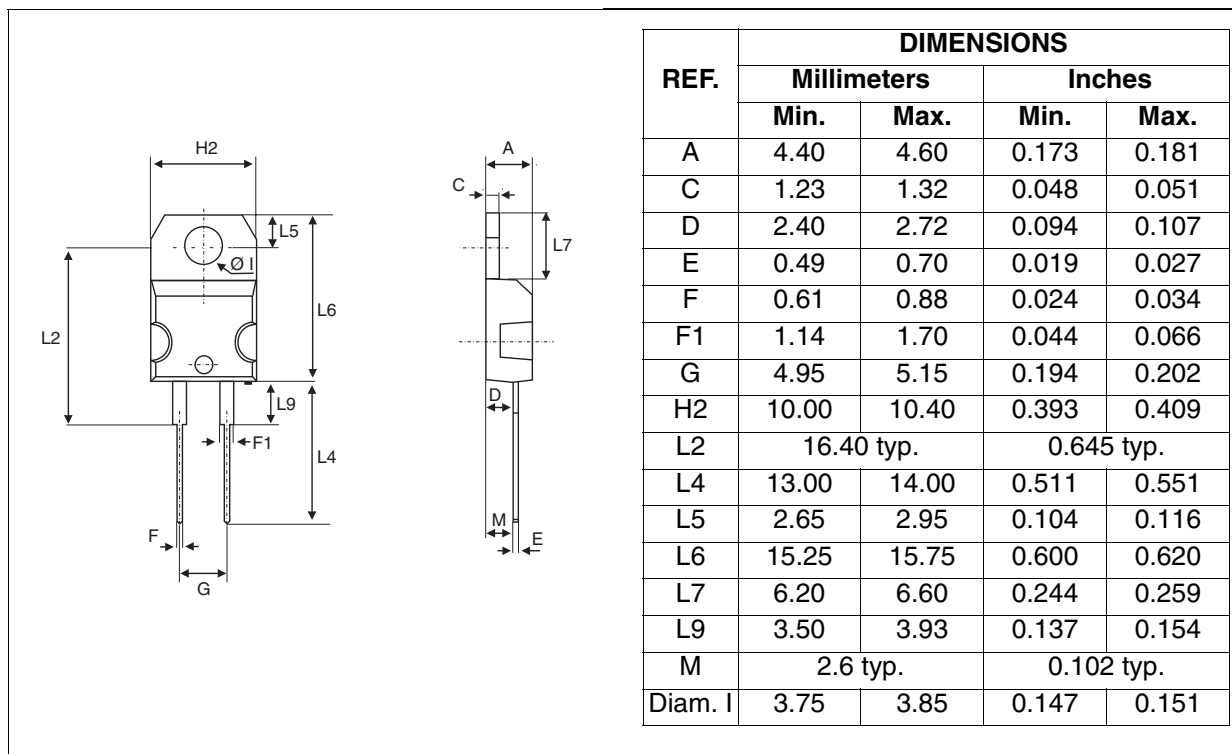

Figure 18: TO-220AC Insulated Package Mechanical Data



STTH12R06

Table 7: Ordering Information

Ordering type	Marking	Package	Weight	Base qty	Delivery mode
STTH12R06D	STTH12R06D	TO-220AC	1.90 g	50	Tube
STTH12R06G	STTH12R06G	D ² PAK	1.48 g	50	Tube
STTH12R066G-TR	STTH12R06G	D ² PAK	1.48 g	1000	Tape & reel
STTH12R06FP	STTH12R06FP	TO-220FPAC	1.70 g	50	Tube
STTH12R06DI	STTH12R06DI	TO-220AC Ins.	1.86 g	250	Box
STTH12R06DIRG	STTH12R06DI	TO-220AC Ins.	1.86 g	50	Tube

- Epoxy meets UL94, V0
- Cooling method: by conduction (C)
- Recommended torque value: 0.8 m.N. (TO-220FPAC) / 0.55 m.N. (TO-220AC)
- Maximum torque value: 1.0 m.N. (TO-220FPAC) / 0.70 m.N. (TO-220AC)

Table 8: Revision History

Date	Revision	Description of Changes
January-2002	1	First issue
18-Oct-2004	2	D ² PAK and TO-220AC Insulated packages added

Information furnished is believed to be accurate and reliable. However, STMicroelectronics assumes no responsibility for the consequences of use of such information nor for any infringement of patents or other rights of third parties which may result from its use. No license is granted by implication or otherwise under any patent or patent rights of STMicroelectronics. Specifications mentioned in this publication are subject to change without notice. This publication supersedes and replaces all information previously supplied. STMicroelectronics products are not authorized for use as critical components in life support devices or systems without express written approval of STMicroelectronics.

The ST logo is a registered trademark of STMicroelectronics.
All other names are the property of their respective owners

© 2004 STMicroelectronics - All rights reserved

STMicroelectronics group of companies

Australia - Belgium - Brazil - Canada - China - Czech Republic - Finland - France - Germany - Hong Kong - India - Israel - Italy - Japan - Malaysia - Malta - Morocco - Singapore - Spain - Sweden - Switzerland - United Kingdom - United States of America

www.st.com

