

SPECIFICATION	MESSRS.
<u>DEVICE TYPE NAME</u>	
Sanken Hybrid Voltage Regulator Module - STR58041A(LF502)	

1. Scope

The present specifications shall only apply to Sanken Hybrid Voltage Regulator, type STR58041A.

2. Features

- a) Hybrid Voltage regulator module with a triple diffused planar transistor incorporated.
- b) For TV switch mode power supply application.
- c) Fixed output Voltage.

3. Equivalent circuit

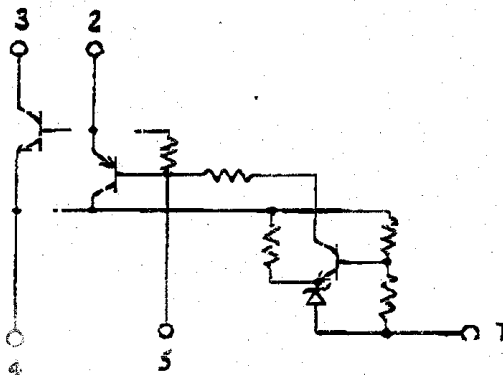

- 1. Vout SENSE (-)
- 2. BASE DRIVE (B)
- 3. INPUT (C)
- 4. EARTH (E)
- 5. Reference Adjust

4. Outline, dimension and pin connection are per Fig.1

5. The type number and lot number shall be marked in white.

DATE ISSUED: Aug. 21, 1996	APPLICATION ENGINEERING	2/18
PREPARED BY: <i>Tatsuo Takasaki</i>	SEMICONDUCTOR DIVISION	
CHECKED BY: <i>Mitsuo Uehara</i>	SPECIFICATION NUMBER	
CHECKED BY: <i>W. S. Lee</i>	SSE-20361E	

6. Absolute Maximum Ratings(Ta=25°C)

Characteristic	Symbol	Unit	Ratings
Collector-Emitter Voltage	V _{CEX}	V	650 (*1)
Input Current	I _{IN}	A	6 (pulse 12)
Maximum Power Dissipation	P _D	W	27 (T _F -100°C)
Operating Temperature	T _{OP}	°C	-20~+105 (T _F) (*2)
Storage Temperature	T _{stg}	°C	-40~+125
Power Tr Junction Temp.	T _j	°C	+150

 (*1) V_{CEO}=6(K)V Min (Reference value)

(*2) Refer to the accelerated data of TFT (Thermal Fatigue Test) on Page.16 for thermal design.

7. Electrical Characteristics(Ta=25°C)

Characteristic	Symbol	Test Conditions	Rating
Fixed Output Voltage.	V _S	I _{IN} =7mA, Test Circuit 1	41.8±0.5V
Output Voltage Temperature Coefficient		T _C =-20~+100°C I _{IN} =7mA, Test Circuit 1	±2.0mV/°C
Collector Saturation Voltage	V _{CE(sat)}	I _C =2A, I _B =0.4A	0.4V Max
DC Current Gain	h _{FE}	V _{CE} =4V, I _C =1A	Min 15 Max 38
Collector Cutoff Current	I _{CEX}	V _{CE} =650V, V _{BE} =-1.5V	250μA Max
Collector-Emitter Voltage	V _{CEX}	I _{CEX} =1.0mA, V _{BE} =-1.5V	850V Min
Base-Emitter Sat. Voltage	V _{BE(sat)}	I _C =2A, I _B =0.4A	1.5V Max
Thermal Resistance	θ _{jF}	Junction to metal frame	1.8 °C/W
Switching Time	Test Circuit 2	t _s	11.0μsec Max
		t _f	0.5μsec Max

※ Power Transistor Characteristics

8. Application Circuit Example(Refer Circuit)

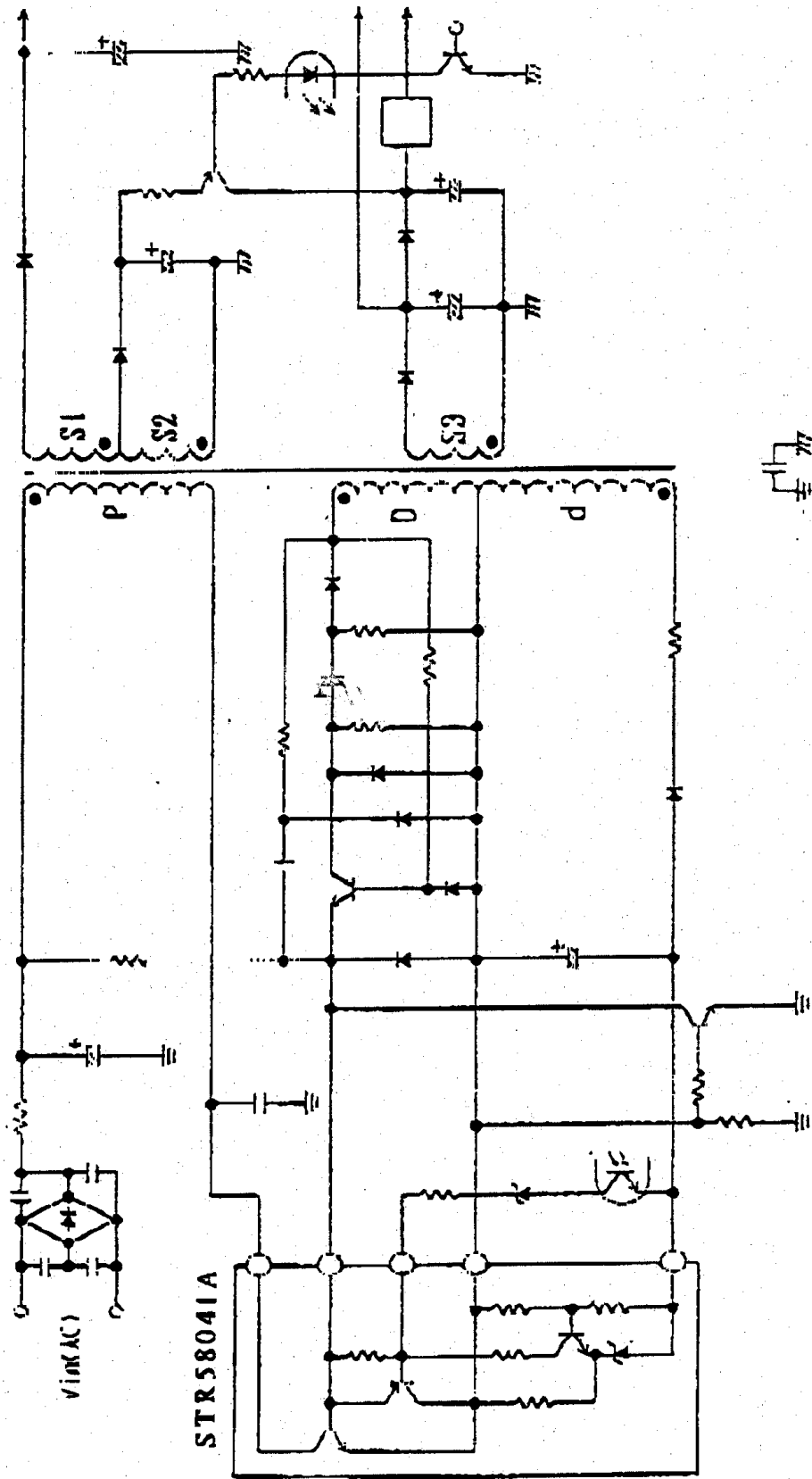

9. Method to the mounting a heatsink

1) Recommended screw torque 6~8 [kg·f·cm]

2) Recommended silicone grease

G-746 (SHINETSU CHEMICAL INDUSTRIES Co., Ltd.)

YG6260 (TOSHIBA SILICONE Co., Ltd.)

SC102 (DAW CORNING TORAY SILICONE CO.,LTD.)

10. Others

Since this device is developed and produced for general purpose , radioactive ray design has not been considered.

Test Circuit 1 : Fixed Output Voltage Test Circuit

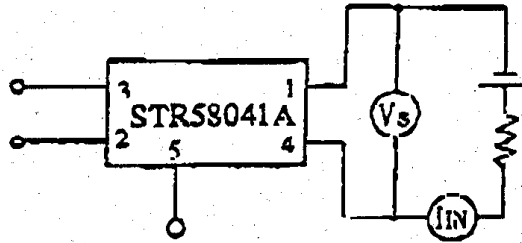

Test Circuit 2 : Switching Time Test Circuit

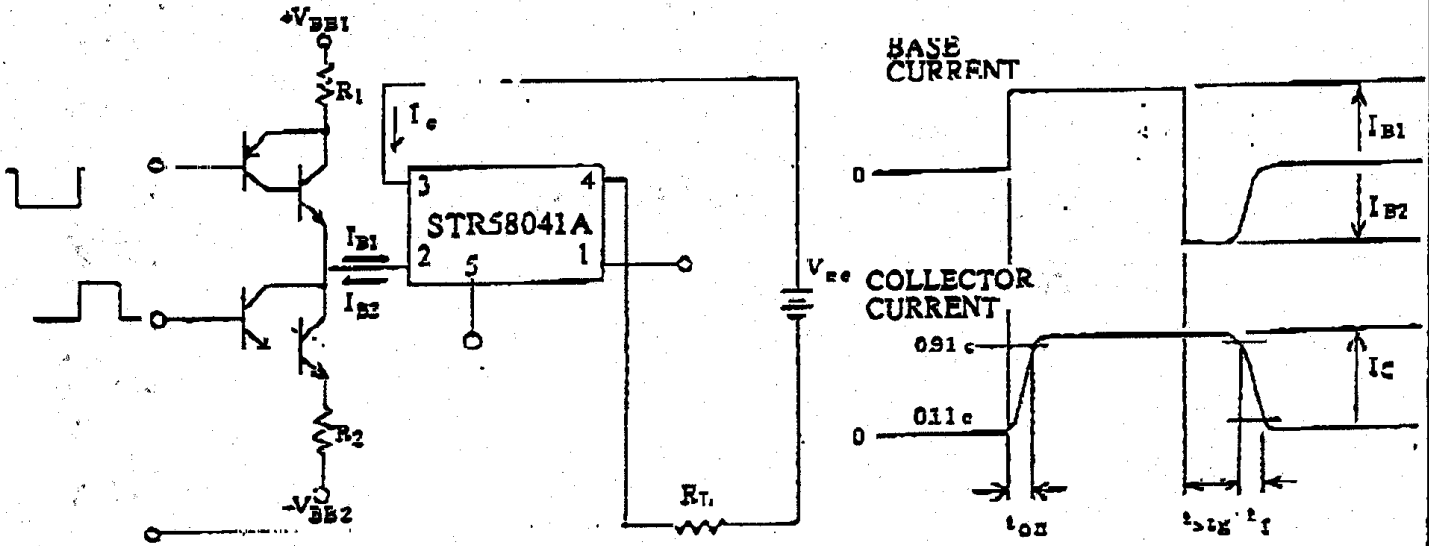

$I_C = 2A, R_L = 100\Omega$

$I_{B1} = 400mA, I_{B2} = 400mA$

Fig-1 : Outline Drawings, Dimensions and Pin Connections
Sanken Lead Forming No. : LF502

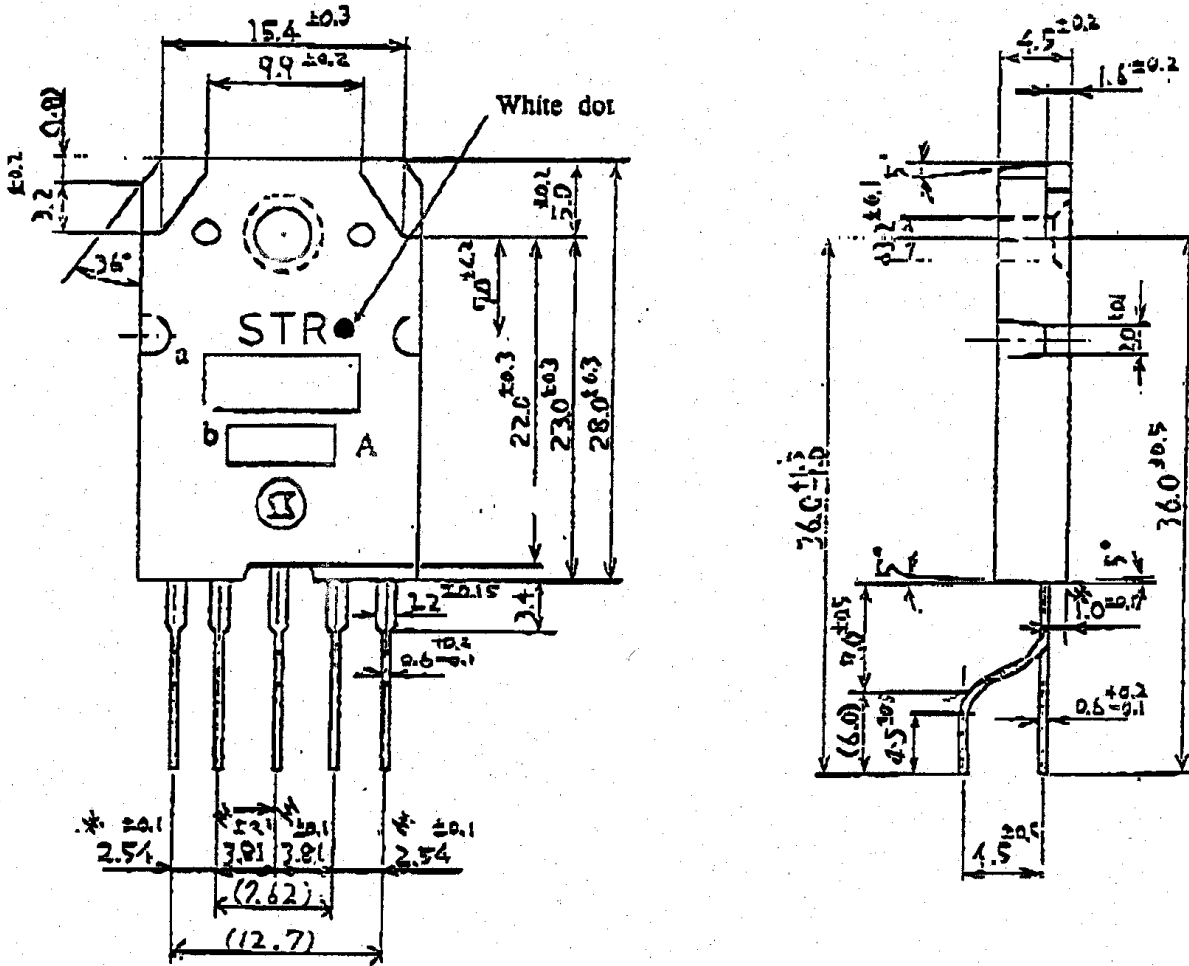

a : Type number 58041

b : Lot number 1st letter - The last digit of year
2nd letter - Month

(1 to 9 for Jan. to Sept.,

O for Oct., N for Nov. and D for Dec.)

3rd & 4th letter - Day

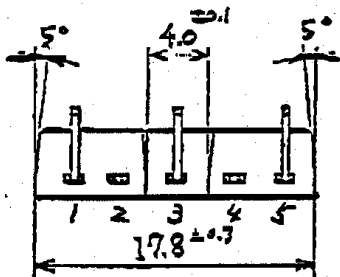

1. Vout SENSE (-)
2. BASE DRIVE (B)
3. INPUT (C)
4. EARTH (E)
5. Reference Adjust

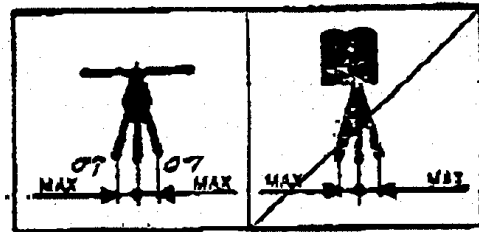

Remarks : The dimensions marked * is measured at the base of lead wires.

Dimensions in mm