



STGD5NB120SZ-1 STGD5NB120SZ

N-CHANNEL 5A - 1200V DPAK/IPAK INTERNALLY CLAMPED PowerMESH™ IGBT

Table 1: General Features

TYPE	V _{CES}	V _{CE(sat)}	I _C
STGD5NB120SZ	1200 V	< 2.0 V	5 A
STGD5NB120SZ-1	1200 V	< 2.0 V	5 A

- HIGH INPUT IMPEDANCE (VOLTAGE DRIVEN)
- LOW ON-VOLTAGE DROP (V_{cesat})
- HIGH CURRENT CAPABILITY
- OFF LOSSES INCLUDE TAIL CURRENT
- HIGH VOLTAGE CLAMPING FEATURES

DESCRIPTION

Using the latest high voltage technology based on a patented strip layout, STMicroelectronics has designed an advanced family of IGBTs, the PowerMESH™ IGBTs, with outstanding performances. The suffix "S" identifies a family optimized achieve minimum on-voltage drop for low frequency applications (<1kHz). The built in collector-gate zener exhibits a very precise active clamping.

APPLICATIONS

- LIGHT DIMMER
- INRUSH CURRENT LIMITATION
- PRE-HEATING FOR ELECTRONIC LAMP BALLAST

Figure 1: Package

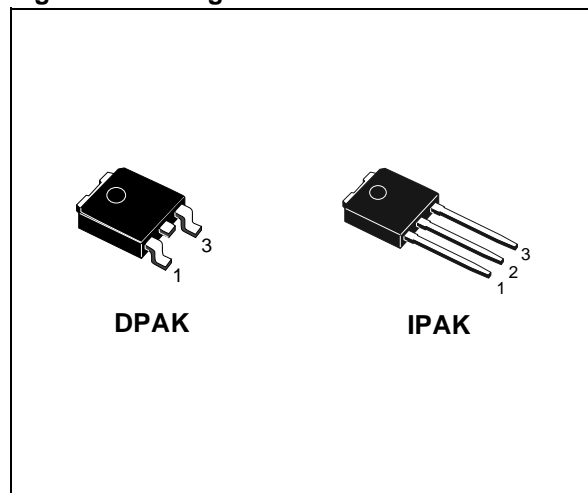

Figure 2: Internal Schematic Diagram

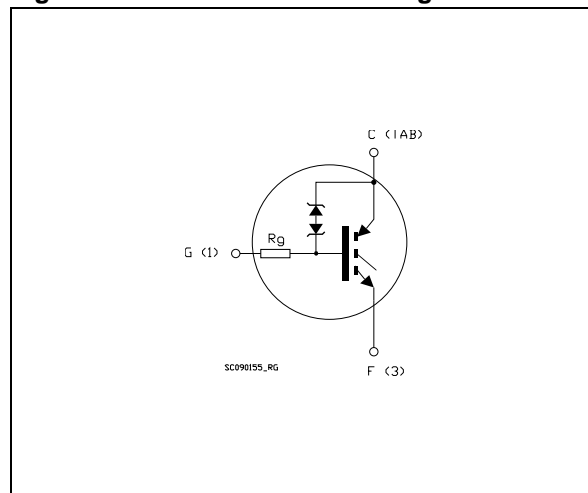

Table 2: Order Code

PART NUMBER	MARKING	PACKAGE	PACKAGING
STGD5NB120SZT4	GD5NB120SZ	DPAK	TAPE & REEL
STGD5NB120SZ-1	GD5NB120SZ	IPAK	TUBE

Table 3: Absolute Maximum ratings

Symbol	Parameter	Value	Unit
V_{CES}	Collector-Emitter Voltage ($V_{GS} = 0$)	1200	V
V_{ECR}	Emitter-Collector Voltage	20	V
V_{GE}	Gate-Emitter Voltage	± 20	V
I_C	Collector Current (continuous) at $T_C = 25^\circ\text{C}$	10	A
I_C	Collector Current (continuous) at $T_C = 100^\circ\text{C}$	5	A
I_{CM} (■)	Collector Current (pulsed)	20	A
P_{TOT}	Total Dissipation at $T_C = 25^\circ\text{C}$	55	W
	Derating Factor	0.44	W/°C
Eas (1)	Single Pulse Avalanche Energy at $T_j = 25^\circ\text{C}$	10	mJ
	Single Pulse Avalanche Energy at $T_j = 100^\circ\text{C}$	7	mJ
T_{stg}	Storage Temperature	-55 to 150	°C
T_j	Operating Junction Temperature range	150	°C

(■) Pulse width limited by safe operating area

(1) $V_{CE} = 50\text{ V}$, $I_{AV} = 3.3\text{ A}$

Table 4: Thermal Data

		Min.	Typ.	Max.	
Rthj-case	Thermal Resistance Junction-case			2.27	°C/W
Rthj-amb	Thermal Resistance Junction-ambient			100	°C/W

ELECTRICAL CHARACTERISTICS ($T_{CASE} = 25^\circ\text{C}$ UNLESS OTHERWISE SPECIFIED)
Table 5: On/Off

Symbol	Parameter	Test Conditions	Min.	Typ.	Max.	Unit
$V_{BR(CES)}$	Collector-Emitter Breakdown Voltage	$I_C = 10\text{ mA}$, $V_{GE} = 0\text{ V}$	1200			V
I_{CES}	Collector cut-off Current ($V_{GE} = 0$)	$V_{CE} = 900\text{ V}$ $V_{CE} = 900\text{ V}$, $T_j = 125^\circ\text{C}$			50 250	μA μA
I_{GES}	Gate-Emitter Leakage Current ($V_{CE} = 0$)	$V_{GE} = \pm 20\text{ V}$, $V_{CE} = 0\text{ V}$			± 100	nA
$V_{GE(th)}$	Gate Threshold Voltage	$V_{CE} = V_{GE}$, $I_C = 250\text{ }\mu\text{A}$	2		5	V
V_{GE}	Gate Emitter Voltage	$V_{CE} = 2.5\text{ V}$, $I_C = 2\text{ A}$, $T_j = 25\div 125^\circ\text{C}$			6.5	V
$V_{CE(sat)}$	Collector-Emitter Saturation Voltage	$V_{GE} = 15\text{ V}$, $I_C = 5\text{ A}$		1.3	2.0	V
		$V_{GE} = 15\text{ V}$, $I_C = 5\text{ A}$, $T_j = 125^\circ\text{C}$		1.2		V

ELECTRICAL CHARACTERISTICS (CONTINUED)

Table 6: Dynamic

Symbol	Parameter	Test Conditions	Min.	Typ.	Max.	Unit
g_{fs}	Forward Transconductance	$V_{CE} = 25\text{ V}$, $I_C = 5\text{ A}$		5		S
$C_{ies}^{(*)}$	Input Capacitance	$V_{CE} = 25\text{ V}$, $f = 1\text{ MHz}$, $V_{GE} = 0\text{ V}$		430		pF
$C_{oes}^{(*)}$	Output Capacitance			40		pF
$C_{res}^{(*)}$	Reverse Transfer Capacitance			7		pF
R_g	Gate Resistance			4		K Ω

(1) Pulsed: Pulse duration= 300 μs , duty cycle 1.5%

Table 7: Switching On

Symbol	Parameter	Test Conditions	Min.	Typ.	Max.	Unit
$t_{d(on)}$	Delay Time	$I_C = 5\text{ A}$, $V_{CC} = 960\text{ V}$ $V_{GE} = 15\text{ V}$, $R_{drive} = 1\text{ K}\Omega$ $T_j = 25^\circ\text{C}$		690		ns
t_r	Current Rise Time			170		ns
$(di/dt)_{on}$	Turn-on Current Slope			39.6		A/ μs
$t_{d(on)}$	Dealy Time	$I_{CC} = 5\text{ A}$, $V_{CC} = 960\text{ V}$ $V_{GE} = 15\text{ V}$, $R_{drive} = 1\text{ K}\Omega$ $T_j = 125^\circ\text{C}$		600		ns
t_r	Current Rise Time			185		ns
$(di/dt)_{on}$	Turn-on Current Slope			39		A/ μs

Table 8: Switching Off

Symbol	Parameter	Test Conditions	Min.	Typ.	Max.	Unit
t_c	Cross-over Time	$I_C = 5\text{ A}$, $V_{CC} = 960\text{ V}$ $V_{GE} = 15\text{ V}$, $R_{drive} = 1\text{ K}\Omega$ $T_j = 25^\circ\text{C}$		4		μs
$t_r(V_{off})$	Off Voltage Rise Time			2.2		μs
$t_{d(off)}$	Delay Time			12.1		μs
t_f	Current Fall Time			1.13		μs
t_c	Cross-over Time	$I_C = 5\text{ A}$, $V_{CC} = 960\text{ V}$ $V_{GE} = 15\text{ V}$, $R_{drive} = 1\text{ K}\Omega$ $T_j = 125^\circ\text{C}$		5		μs
$t_r(V_{off})$	Off Voltage Rise Time			2.2		μs
$t_{d(off)}$	Delay Time			12.1		μs
t_f	Current Fall Time			2		μs

Table 9: Switching Energy

Symbol	Parameter	Test Conditions	Min.	Typ.	Max.	Unit
$E_{on(2)}$	Turn-on Switching Losses	$V_{CC} = 800\text{ V}$, $I_C = 3\text{ A}$ $R_G = 10\ \Omega$, $V_{GE} = 15\text{ V}$, $T_j = 25^\circ\text{C}$ (see Figure 18)		2.59		mJ
$E_{off(3)}$	Turn-off Switching Loss			9		mJ
E_{ts}	Total Switching Loss			11.59		mJ
$E_{on(2)}$	Turn-on Switching Losses	$V_{CC} = 800\text{ V}$, $I_C = 3\text{ A}$ $R_G = 10\ \Omega$, $V_{GE} = 15\text{ V}$, $T_j = 125^\circ\text{C}$ (see Figure 18)		2.64		mJ
$E_{off(3)}$	Turn-off Switching Loss			10.2		mJ
E_{ts}	Total Switching Loss			12.68		mJ

(2) E_{on} is the turn-on losses when a typical diode is used in the test circuit in figure 2.

(3) Turn-off losses include also the tail of the collector current.

Table 10: Functional Test

Symbol	Parameter	Test Conditions	Min.	Typ.	Max	Unit
I _{as}	Unclamped inductive switching current	V _{CC} = 50 V, L = 1.8 mH T _{start} = 25°C, R _{drive} = 1KΩ	3.3			A
I _{CL}	Latching Current	V _{CLAMP} = 960 V, T _j = 125°C R _{drive} = 1KΩ		10		A

Figure 3: Output Characteristics

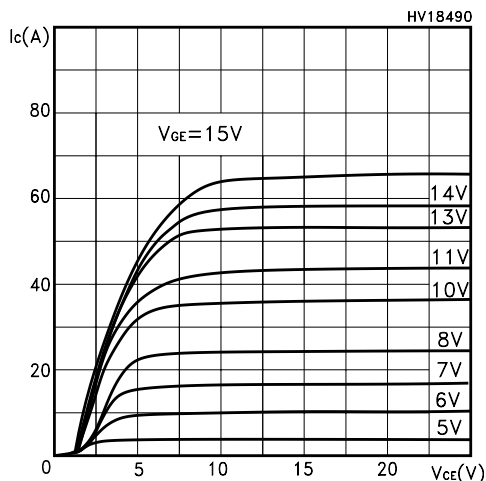

Figure 4: Transconductance

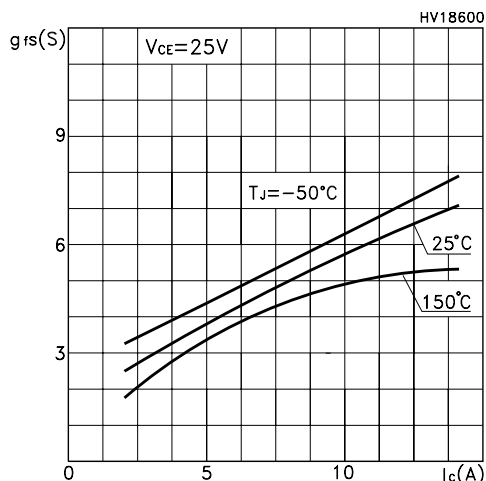

Figure 5: Collector-Emitter On Voltage vs Collector Current

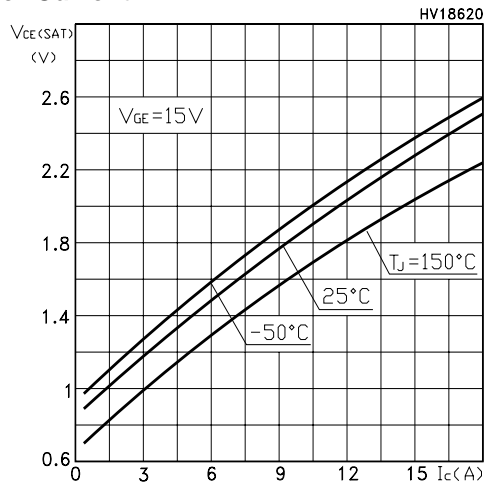

Figure 6: Transfer Characteristics

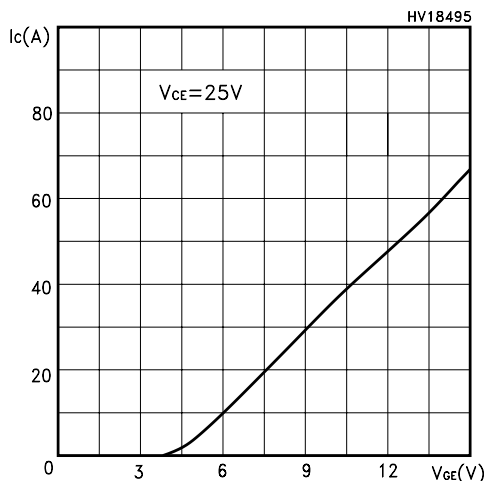

Figure 7: Collector-Emitter On Voltage vs Temperature

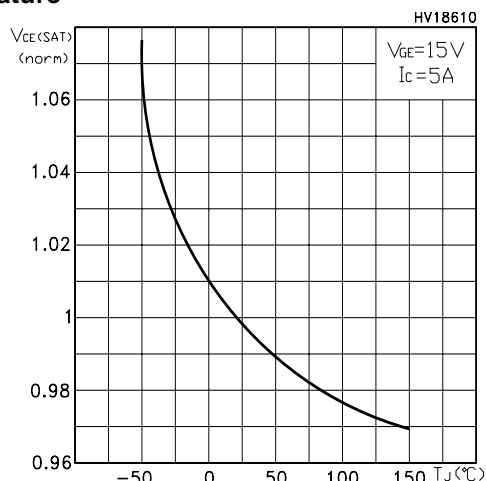

Figure 8: Normalized Gate Threshold vs Temperature

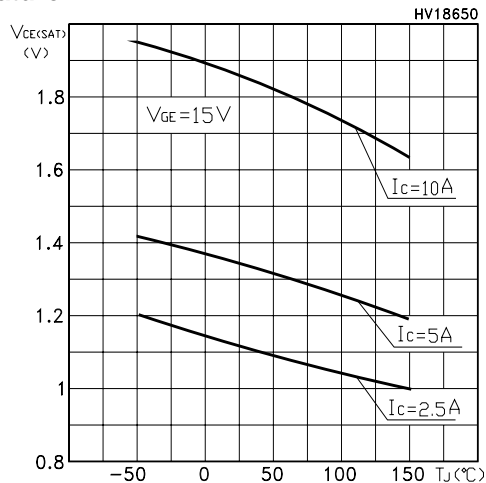

Figure 9: Gate Threshold vs Temperature

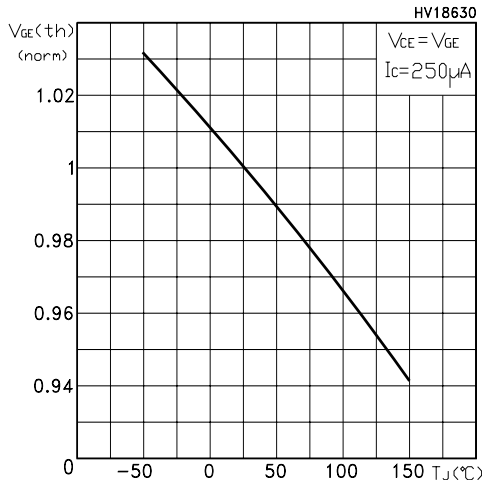

Figure 10: Capacitance Variations

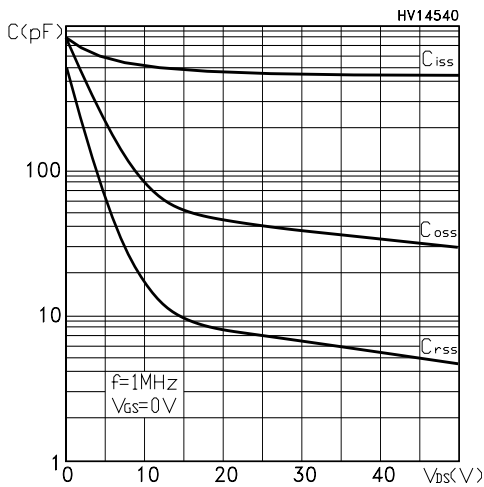

Figure 11: Switching Losses vs Gate Resistance

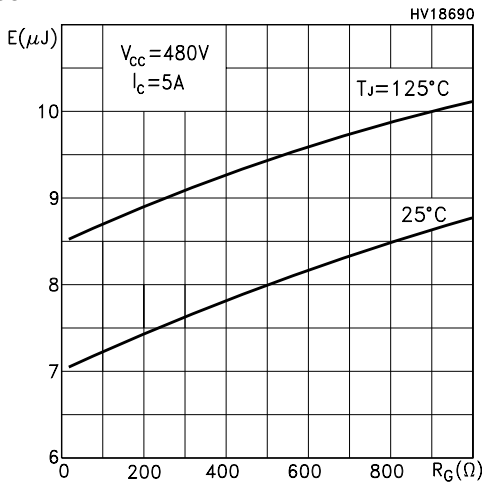

Figure 12: Breakdown Voltage vs Temperature

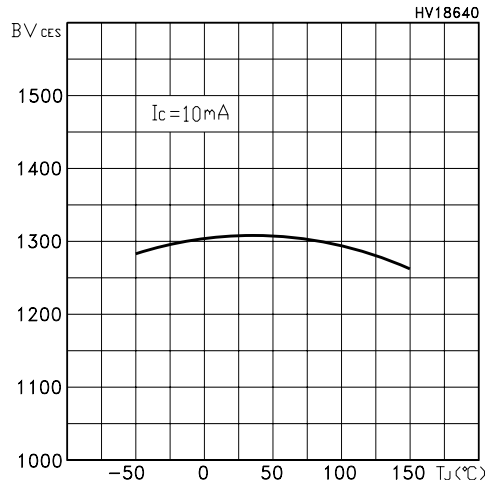

Figure 13: Gate-Charge vs Gate-Emitter Voltage

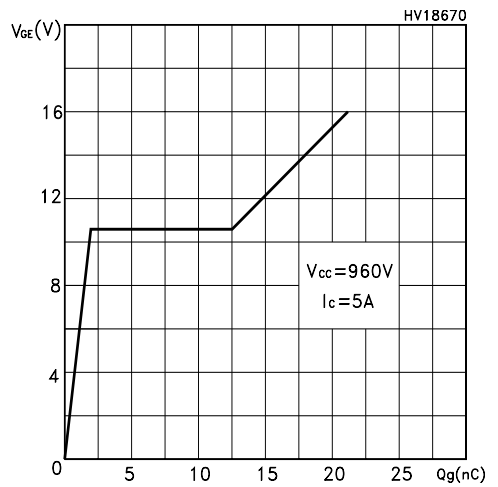

Figure 14: Switching Losses vs Collector Current

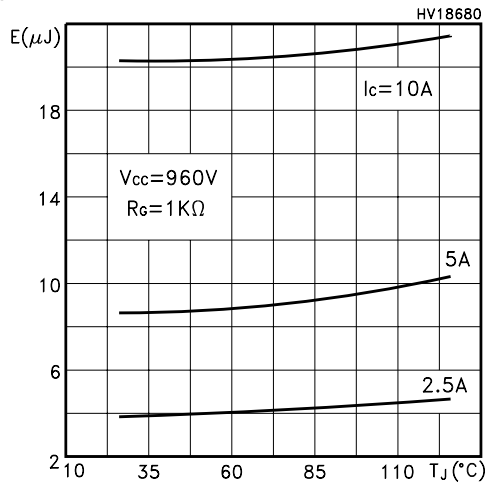

Figure 15: Thermal Impedance

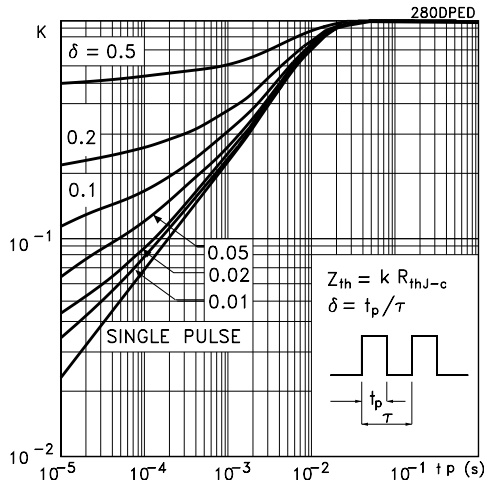
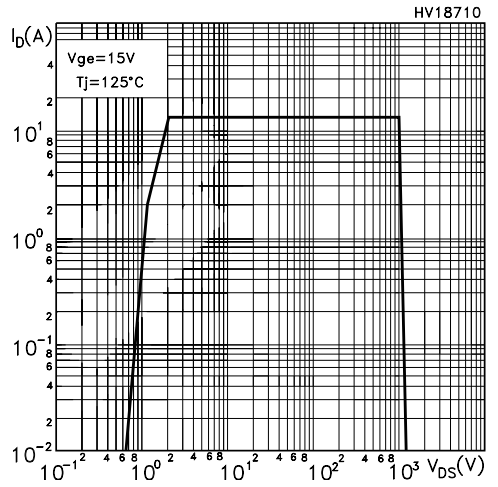
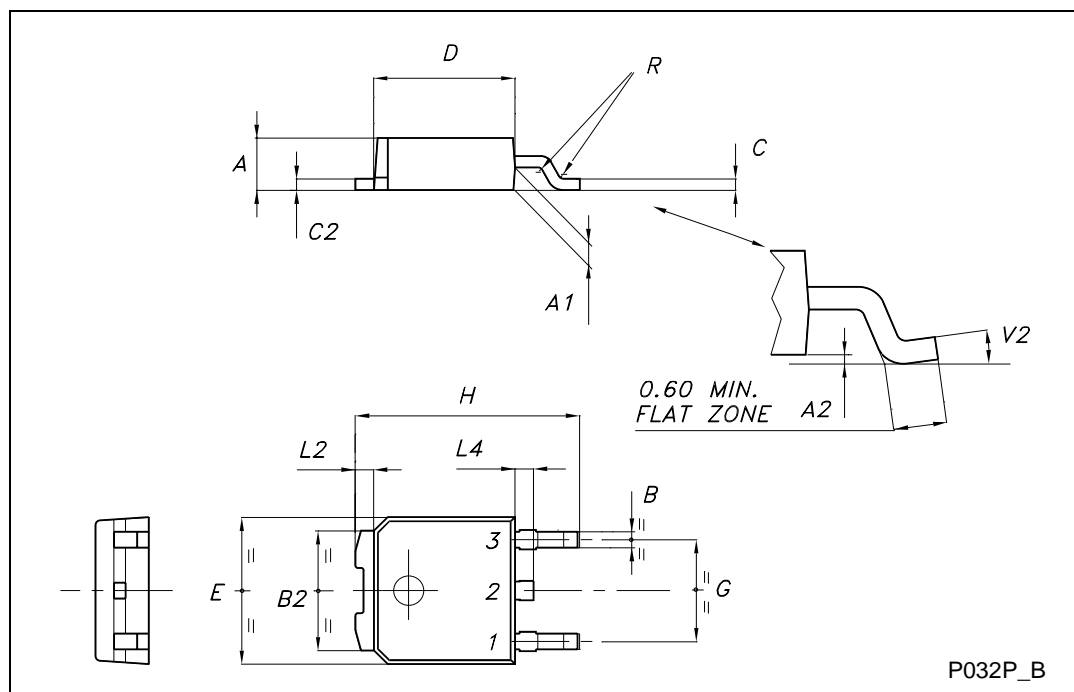

Figure 16: Turn-Off SOA



TO-252 (DPAK) MECHANICAL DATA

DIM.	mm			inch		
	MIN.	TYP.	MAX.	MIN.	TYP.	MAX.
A	2.20		2.40	0.087		0.094
A1	0.90		1.10	0.035		0.043
A2	0.03		0.23	0.001		0.009
B	0.64		0.90	0.025		0.035
B2	5.20		5.40	0.204		0.213
C	0.45		0.60	0.018		0.024
C2	0.48		0.60	0.019		0.024
D	6.00		6.20	0.236		0.244
E	6.40		6.60	0.252		0.260
G	4.40		4.60	0.173		0.181
H	9.35		10.10	0.368		0.398
L2		0.8			0.031	
L4	0.60		1.00	0.024		0.039
V2	0°		8°	0°		0°



TO-251 (IPAK) MECHANICAL DATA

DIM.	mm			inch		
	MIN.	TYP.	MAX.	MIN.	TYP.	MAX.
A	2.2		2.4	0.086		0.094
A1	0.9		1.1	0.035		0.043
A3	0.7		1.3	0.027		0.051
B	0.64		0.9	0.025		0.031
B2	5.2		5.4	0.204		0.212
B3			0.85			0.033
B5		0.3			0.012	
B6			0.95			0.037
C	0.45		0.6	0.017		0.023
C2	0.48		0.6	0.019		0.023
D	6		6.2	0.236		0.244
E	6.4		6.6	0.252		0.260
G	4.4		4.6	0.173		0.181
H	15.9		16.3	0.626		0.641
L	9		9.4	0.354		0.370
L1	0.8		1.2	0.031		0.047
L2		0.8	1		0.031	0.039

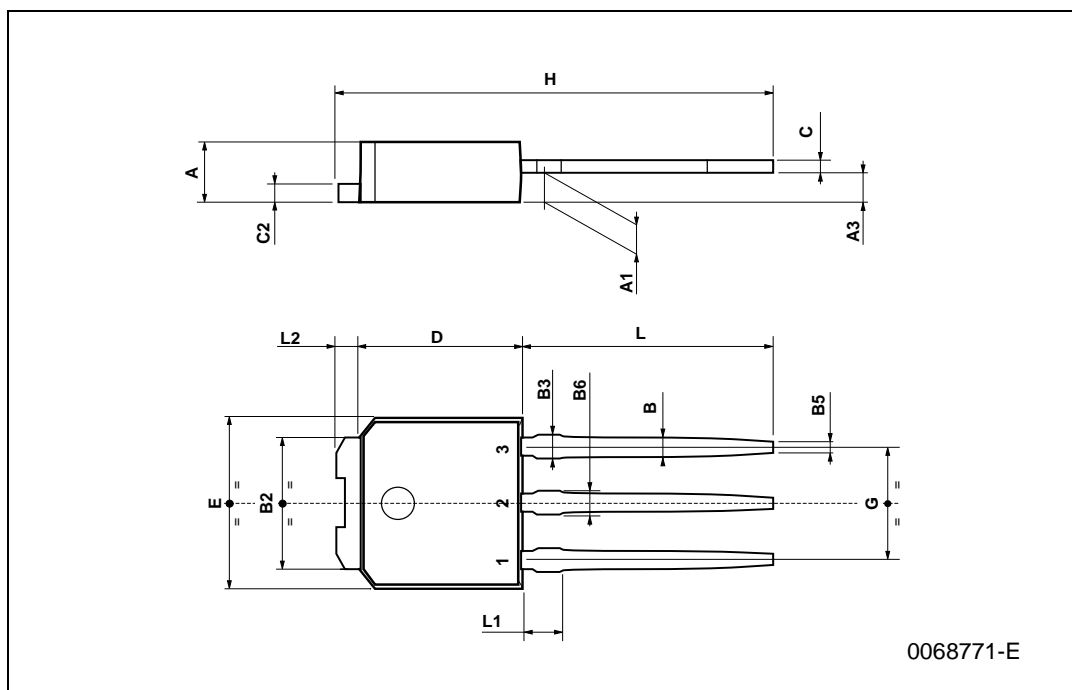

DPAK FOOTPRINT

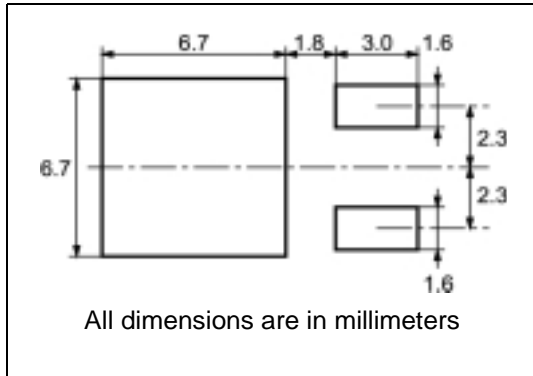

TUBE SHIPMENT (no suffix)*

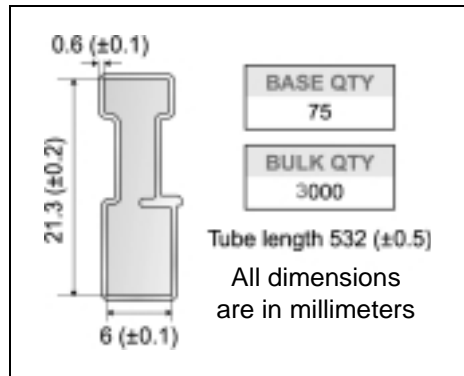

TAPE AND REEL SHIPMENT (suffix "T4")*

40 mm min. Access hole at slot location

Full radius

Tape slot in core for tape start 2.5mm min. width

G measured at hub

REEL MECHANICAL DATA

DIM.	mm		inch	
	MIN.	MAX.	MIN.	MAX.
A		330		12.992
B	1.5		0.059	
C	12.8	13.2	0.504	0.520
D	20.2		0.795	
G	16.4	18.4	0.645	0.724
N	50		1.968	
T		22.4		0.881

BASE QTY	BULK QTY
2500	2500

TAPE MECHANICAL DATA

DIM.	mm		inch	
	MIN.	MAX.	MIN.	MAX.
A0	6.8	7	0.267	0.275
B0	10.4	10.6	0.409	0.417
B1		12.1		0.476
D	1.5	1.6	0.059	0.063
D1	1.5		0.059	
E	1.65	1.85	0.065	0.073
F	7.4	7.6	0.291	0.299
K0	2.55	2.75	0.100	0.108
P0	3.9	4.1	0.153	0.161
P1	7.9	8.1	0.311	0.319
P2	1.9	2.1	0.075	0.082
R	40		1.574	
W	15.7	16.3	0.618	0.641

TOP COVER TAPE

10 pitches cumulative tolerance on tape +/- 0.2 mm

User Direction of Feed

FEED DIRECTION

Bending radius R min.

* on sales type

Table 11: Revision History

Date	Revision	Description of Changes
06-Oct-2003	1	First release
18-Jan-2005	2	Final datasheet

Information furnished is believed to be accurate and reliable. However, STMicroelectronics assumes no responsibility for the consequences of use of such information nor for any infringement of patents or other rights of third parties which may result from its use. No license is granted by implication or otherwise under any patent or patent rights of STMicroelectronics. Specifications mentioned in this publication are subject to change without notice. This publication supersedes and replaces all information previously supplied. STMicroelectronics products are not authorized for use as critical components in life support devices or systems without express written approval of STMicroelectronics.

The ST logo is a registered trademark of STMicroelectronics

All other names are the property of their respective owners

© 2005 STMicroelectronics - All Rights Reserved

STMicroelectronics group of companies

Australia - Belgium - Brazil - Canada - China - Czech Republic - Finland - France - Germany - Hong Kong - India - Israel - Italy - Japan - Malaysia - Malta - Morocco - Singapore - Spain - Sweden - Switzerland - United Kingdom - United States of America