

## Solid State Hall-effect Sensors Economical Linear Position Sensor

## SS49E/SS59ET Series

### FEATURES

- Miniature construction
- Power consumption of 6 mA at 5 Vdc for energy efficiency
- Single current sourcing output
- Linear output for circuit design flexibility
- Low noise output virtually eliminates the need for filtering
- Thin film resistors for a stable and accurate output
- Temperature range of -40 °C to 100 °C [-40 °F to 212 °F]
- Responds to either positive or negative gauss

### TYPICAL APPLICATIONS

- Current sensing
- Motor control
- Position sensing
- Magnetic code reading
- Rotary encoder
- Ferrous metal detector
- Vibration sensing
- Liquid level sensing
- Weight sensing



The SS49E and SS59ET Series Economical Linear Hall-effect sensors are small, versatile linear Hall-effect devices that are operated by the magnetic field from a permanent magnet or an electromagnet. The linear sourcing output voltage is set by the supply voltage and varies in proportion to the strength of the magnetic field.

The integrated circuitry features low noise output, which makes it unnecessary to use external filtering. It also includes thin film resistors to provide increased temperature stability and accuracy. These linear Hall sensors have an operating temperature range of -40 °C to 100 °C [-40 °F to 212 °F], appropriate for commercial, consumer, and industrial environments.



### WARNING

#### PERSONAL INJURY

DO NOT USE these products as safety or emergency stop devices or in any other application where failure of the product could result in personal injury.

**Failure to comply with these instructions could result in death or serious injury.**



### WARNING

#### MISUSE OF DOCUMENTATION

- The information presented in this product sheet is for reference only. Do not use this document as a product installation guide.
- Complete installation, operation, and maintenance information is provided in the instructions supplied with each product.

**Failure to comply with these instructions could result in death or serious injury.**

# Solid State Hall-effect Sensors

## Economical Linear Position Sensor

# SS49E/SS59ET

## Series

### OPERATING CHARACTERISTICS ( $V_s = 5.0 \text{ V}$ , $T_A = -40 \text{ }^\circ\text{C}$ TO $85 \text{ }^\circ\text{C}$ , EXCEPT WHERE NOTED)

Supply Voltage (Vdc)		3.0 to 6.5
Supply Current (mA)	Typ.	6
@ 25 °C	Max.	10
Output Current (mA)	Min. ( $V_s > 3.0 \text{ V}$ )	1.0
	Typ. ( $V_s > 3.0 \text{ V}$ )	1.5
Output Voltage (mV/G)	Min.	1.0
	Typ.	1.4
	Max.	1.75
Null @ 0 gauss, 25 °C (Vdc)	Min.	2.25
	Typ.	2.50
	Max.	2.75
Output Voltage Span (Vdc)	Min.	1.05 to ( $V_s - 1.05$ )
	Typ.	0.95 to ( $V_s - 0.95$ )
Magnetic Range (Gauss)	Min.	$\pm 650$
	Typ.	$\pm 1000$
Linearity (% of Span)		-0.7
Output Type		Linear, Sourcing
Magnetics Type		Analog
Response Time ( $\mu\text{s}$ )		3
Sensitivity (mV/Gauss)	Min.	1.0
@ 25 °C	Typ.	1.4
	Max.	1.75
Operating Temperature		$-40 \text{ }^\circ\text{C}$ to $100 \text{ }^\circ\text{C}$ [ $-40 \text{ }^\circ\text{F}$ to $212 \text{ }^\circ\text{F}$ ]
Temperature Error (%/°C)		
Null Drift	Min.	-0.10
	Max.	0.10
Sensitivity Drift	$\geq 25 \text{ }^\circ\text{C}$ Min.	-0.15
	$\geq 25 \text{ }^\circ\text{C}$ Max.	0.05
	$< 25 \text{ }^\circ\text{C}$ Min.	-0.04
	$< 25 \text{ }^\circ\text{C}$ Max.	0.185

### ABSOLUTE MAXIMUM RATINGS\*

Supply Voltage ( $V_s$ )	-0.5 Vdc to 8.0 Vcd
Output Current	10 mA
Storage Temperature	$-55 \text{ }^\circ\text{C}$ to $165 \text{ }^\circ\text{C}$ [ $-67 \text{ }^\circ\text{F}$ to $329 \text{ }^\circ\text{F}$ ]

\*Absolute maximum ratings are the extreme limits the device will withstand without damage to the device. However, the electrical and mechanical characteristics are not guaranteed as the maximum limits (above recommended operating conditions) are approached, nor will the device necessarily operate at absolute maximum ratings.

### BLOCK DIAGRAM CURRENT SOURCING OUTPUT

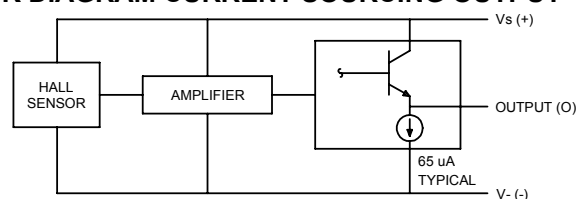

### TRANSFER CHARACTERISTICS ( $V_s = 5.0 \text{ VDC}$ )

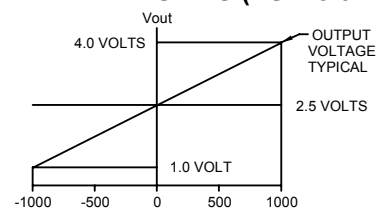

# Solid State Hall-Effect Sensors

## Economical Linear Position Sensor

# SS49E/SS59ET Series

### SS49E SERIES MOUNTING DIMENSIONS mm/[in] (for reference only)

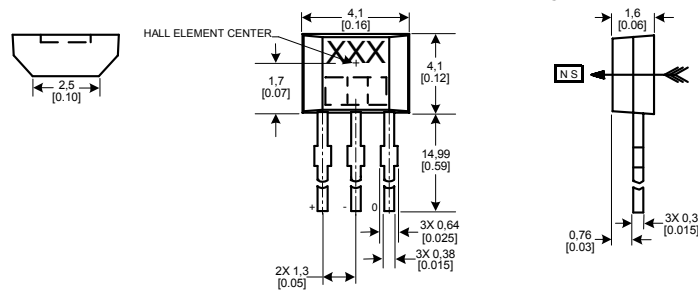

### TAPE STYLE T2

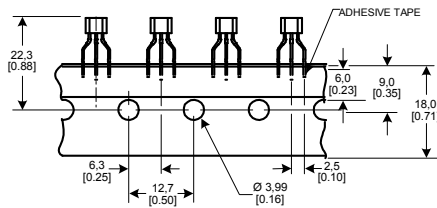

### TAPE STYLE T3

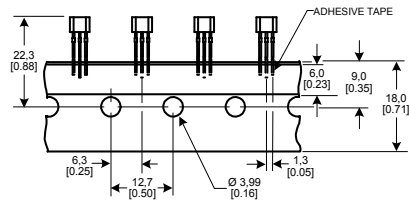

### SS59ET SERIES MOUNTING DIMENSIONS mm/[in] (for reference only)

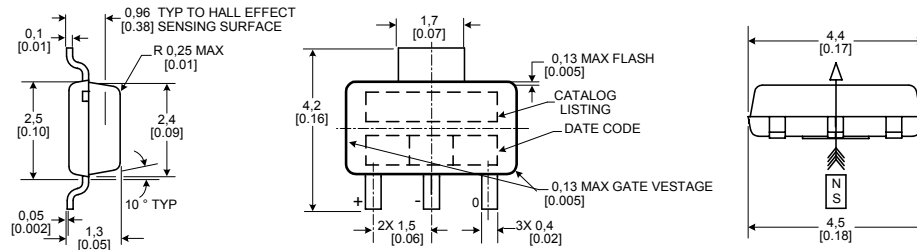

### TAPE DIMENSIONS (sold in tape and reel form only, per EIA STD 481; 1,000 parts per reel)

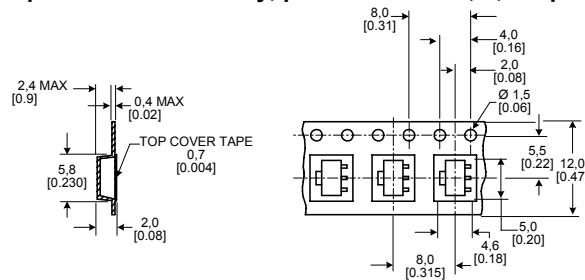

### REEL DIMENSIONS

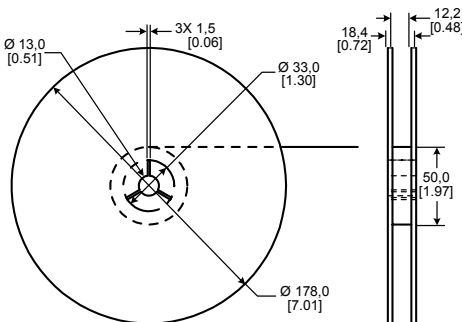

# Solid State Hall-effect Sensors

## Economical Linear Position Sensor

# SS49E/SS59ET

## Series

### ORDER GUIDE

Catalog Listing	Description
SS49E	Standard leaded version
SS49E-L	Long-leaded version
SS49E-T2	Tape-and-reel version with formed leads
SS49E-T3	Tape-and-reel version with straight leads
SS59ET	Standard surface-mount version

### NOTICE

Products ordered in bulk packaging (plastic bags) may not have perfectly straight leads as a result of normal handling and shipping operations. Please order a tape packaging option for applications with critical requirements for straight leads.

### WARRANTY/REMEDY

Honeywell warrants goods of its manufacture as being free of defective materials and faulty workmanship. Contact your local sales office for warranty information. If warranted goods are returned to Honeywell during the period of coverage, Honeywell will repair or replace without charge those items it finds defective. **The foregoing is Buyer's sole remedy and is in lieu of all other warranties, expressed or implied, including those of merchantability and fitness for a particular purpose.**

Specifications may change without notice. The information we supply is believed to be accurate and reliable as of this printing. However, we assume no responsibility for its use. While we provide application assistance personally, through our literature and the Honeywell Web site, it is up to the customer to determine the suitability of the product in the application.

For application assistance, current specifications, or name of the nearest Authorized Distributor, contact a nearby sales office. Or call:

1-800-537-6945 USA  
1-800-737-3360 Canada  
1-815-235-6847 International

### FAX

1-815-235-6545 USA

### INTERNET

[www.honeywell.com/sensing](http://www.honeywell.com/sensing)  
[info.sc@honeywell.com](mailto:info.sc@honeywell.com)

# Honeywell

### Sensing and Control

Honeywell  
11 West Spring Street  
Freeport, Illinois 61032  
005850-1-EN IL50 GLO 0803 Printed in USA  
Copyright 2003 Honeywell International Inc.

[www.honeywell.com/sensing](http://www.honeywell.com/sensing)