



ELECTROSTATIC SENSITIVE DEVICE
OBSERVE HANDLING PRECAUTIONS

MITSUBISHI RF POWER MOS FET

RD07MVS1B

RoHS Compliance, Silicon MOSFET Power Transistor, 175MHz, 520MHz, 7W

DESCRIPTION

RD07MVS1B is a MOS FET type transistor specifically designed for VHF/UHF RF power amplifiers applications. RD07MVS1B improved a drain surge than RD07MVS1 by optimizing MOSFET structure.

FEATURES

High power gain:
 $P_{out} > 7W$, $G_p > 10dB$
 @ $V_{dd} = 7.2V$, $f = 520MHz$
 High Efficiency: 60%typ. (175MHz)
 High Efficiency: 55%typ. (520MHz)

APPLICATION

For output stage of high power amplifiers in VHF/UHF band mobile radio sets.

OUTLINE DRAWING

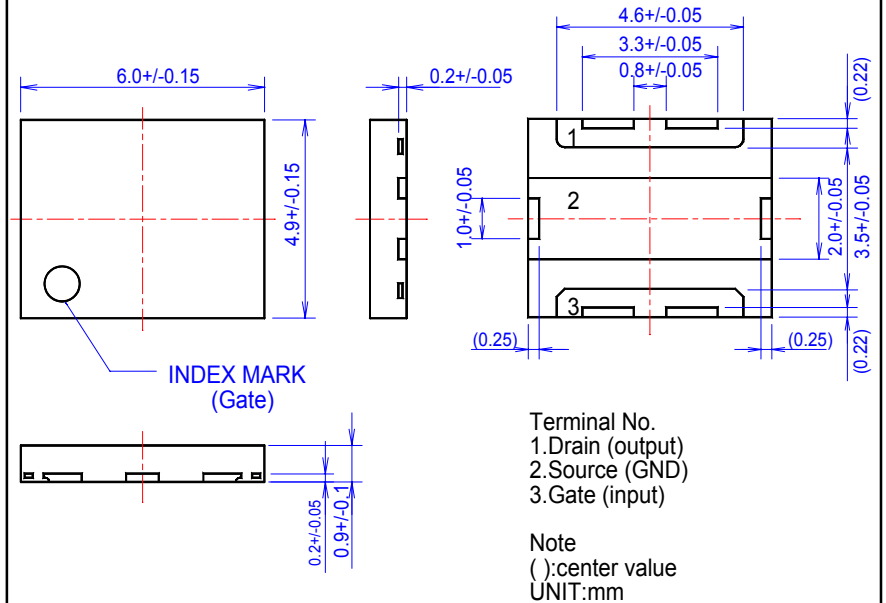

RoHS COMPLIANT

RD07MVS1B-101, T112 is a RoHS compliant product. RoHS compliance is indicated by the letter "G" after the Lot Marking. This product includes the lead in high melting temperature type solders. However, it is applicable to the following exceptions of RoHS Directives.

- Lead in high melting temperature type solders (i.e. tin-lead solder alloys containing more than 85% lead.)

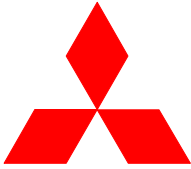

ELECTROSTATIC SENSITIVE DEVICE
OBSERVE HANDLING PRECAUTIONS

MITSUBISHI RF POWER MOS FET
RD07MVS1B

RoHS Compliance, Silicon MOSFET Power Transistor, 175MHz, 520MHz, 7W

ABSOLUTE MAXIMUM RATINGS

(Tc=25°C UNLESS OTHERWISE NOTED)

SYMBOL	PARAMETER	CONDITIONS	RATINGS	UNIT
VDSS	Drain to source voltage	Vgs=0V	30	V
VGSS	Gate to source voltage	Vds=0V	+/- 20	V
Pch	Channel dissipation	Tc=25°C	50	W
Pin	Input Power	Zg=Zl=50Ω	1.5	W
ID	Drain Current	-	3	A
Tch	Junction Temperature	-	150	°C
Tstg	Storage temperature	-	-40 to +125	°C
Rth j-c	Thermal resistance	Junction to case	2.5	°C/W

Note: Above parameters are guaranteed independently.

ELECTRICAL CHARACTERISTICS (Tc=25°C, UNLESS OTHERWISE NOTED)

SYMBOL	PARAMETER	CONDITIONS	LIMITS			UNIT
			MIN	TYP	MAX.	
Idss	Drain cutoff current	VDS=17V, VGS=0V	-	-	200	uA
Igss	Gate cutoff current	VGS=10V, VDS=0V	-	-	1	uA
VTH	Gate threshold Voltage	VDS=12V, Ids=1mA	1.4	1.7	2.4	V
Pout1	Output power	f=175MHz, VDD=7.2V	7	8	-	W
ηD1	Drain efficiency	Pin=0.3W, Idq=700mA	55	60	-	%
Pout2	Output power	f=520MHz, VDD=7.2V	7	8	-	W
ηD2	Drain efficiency	Pin=0.7W, Idq=750mA	50	55	-	%
	Load VSWR tolerance	VDD=9.2V, Po=7W(Pin Control) f=175MHz, Idq=700mA, Zg=50Ω Load VSWR=20:1(All Phase)	No destroy			-
	Load VSWR tolerance	VDD=9.2V, Po=7W(Pin Control) f=520MHz, Idq=750mA, Zg=50Ω Load VSWR=20:1(All Phase)	No destroy			-

Note: Above parameters, ratings, limits and conditions are subject to change.



ELECTROSTATIC SENSITIVE DEVICE
OBSERVE HANDLING PRECAUTIONS

MITSUBISHI RF POWER MOS FET

RD07MVS1B

RoHS Compliance, Silicon MOSFET Power Transistor, 175MHz, 520MHz, 7W

TYPICAL CHARACTERISTICS

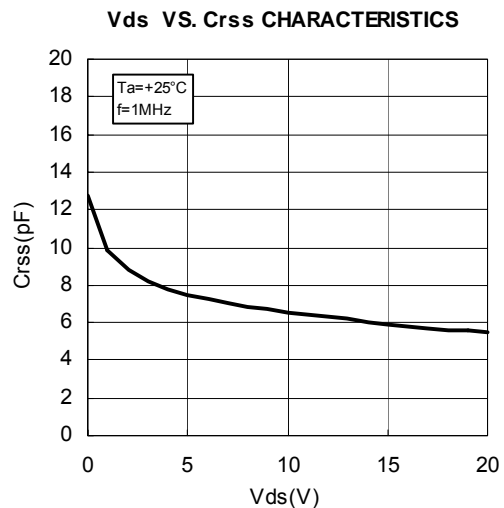
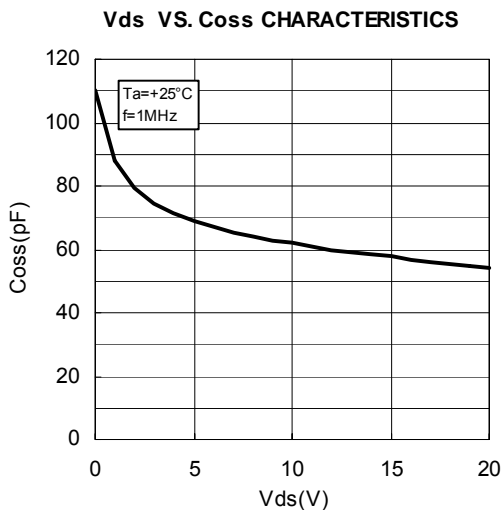
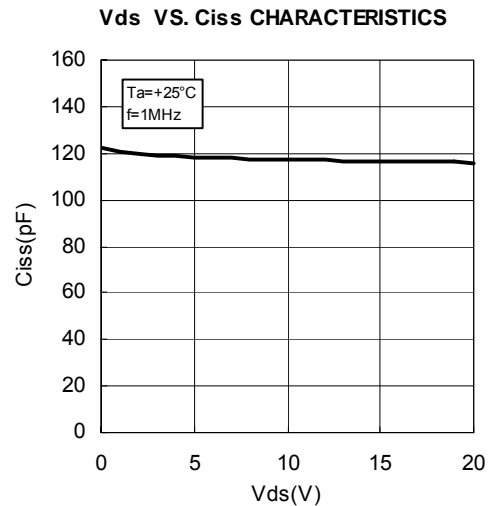
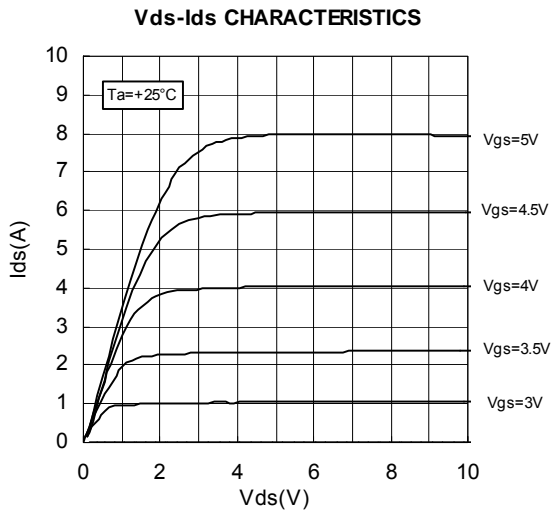
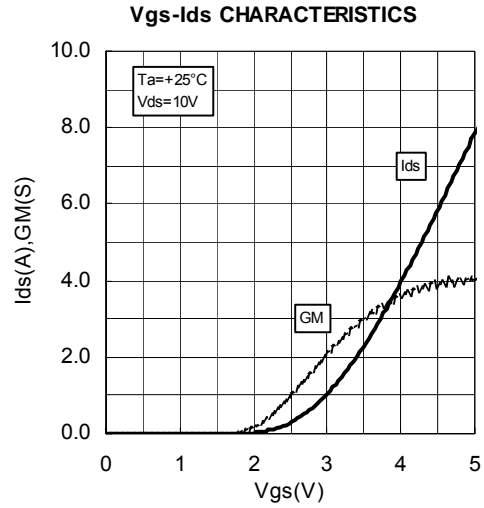
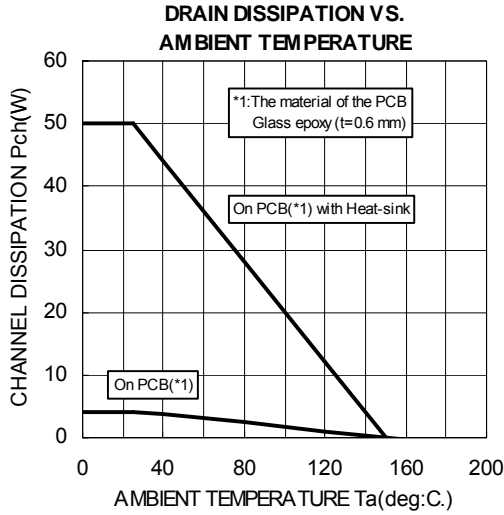



ELECTROSTATIC SENSITIVE DEVICE
OBSERVE HANDLING PRECAUTIONS

MITSUBISHI RF POWER MOS FET RD07MVS1B

RoHS Compliance, Silicon MOSFET Power Transistor, 175MHz, 520MHz, 7W

TYPICAL CHARACTERISTICS

Pin-Po CHARACTERISTICS
@f=175MHz

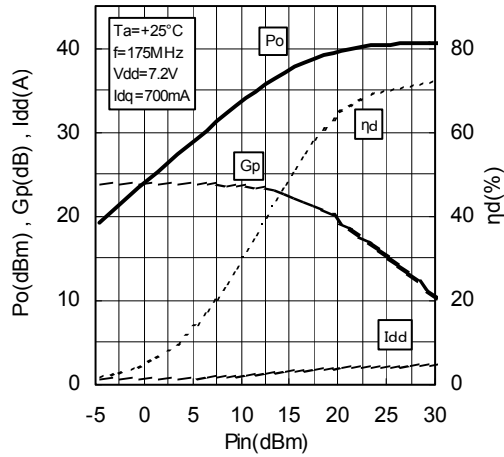

Pin-Po CHARACTERISTICS
@f=175MHz

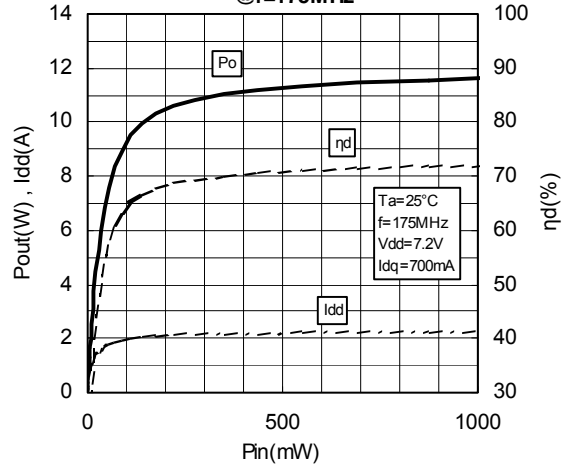

Pin-Po CHARACTERISTICS
@f=520MHz

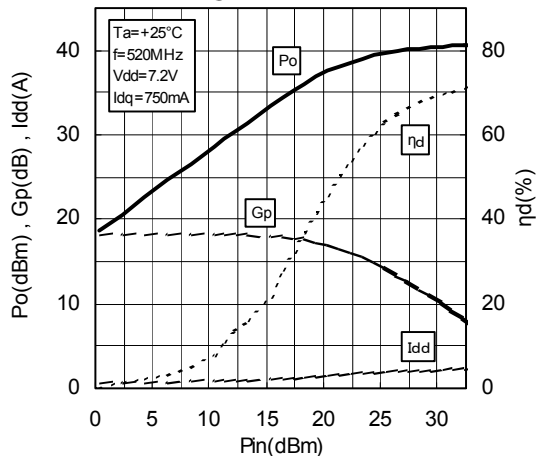

Pin-Po CHARACTERISTICS
@f=520MHz

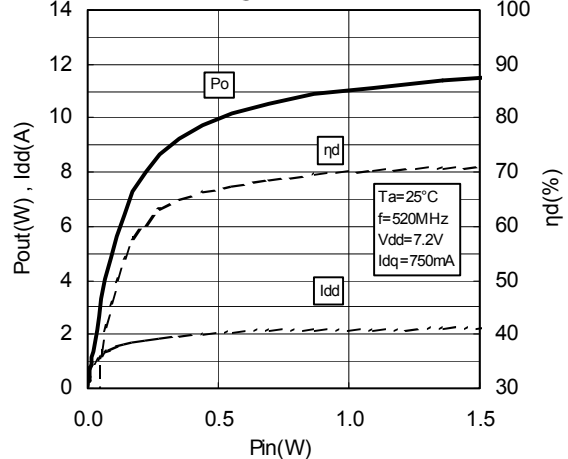

Vdd-Po CHARACTERISTICS
@f=175MHz

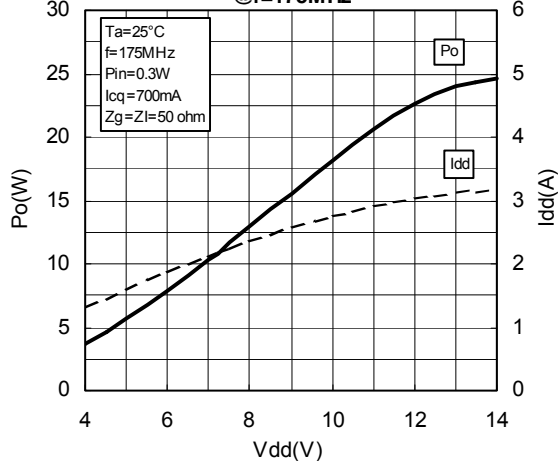

Vdd-Po CHARACTERISTICS
@f=520MHz

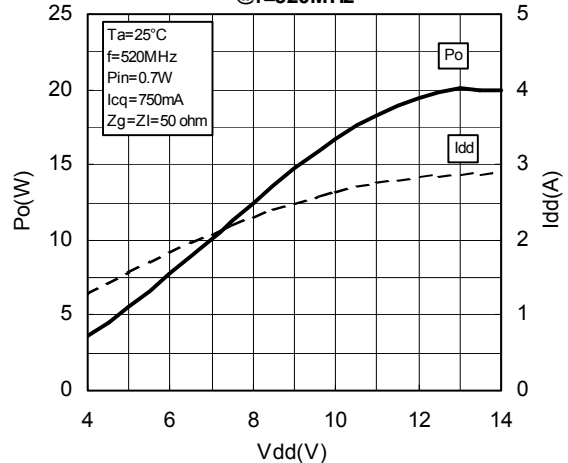



ELECTROSTATIC SENSITIVE DEVICE
OBSERVE HANDLING PRECAUTIONS

MITSUBISHI RF POWER MOS FET RD07MVS1B

RoHS Compliance, Silicon MOSFET Power Transistor, 175MHz, 520MHz, 7W

TEST CIRCUIT(f=175MHz)

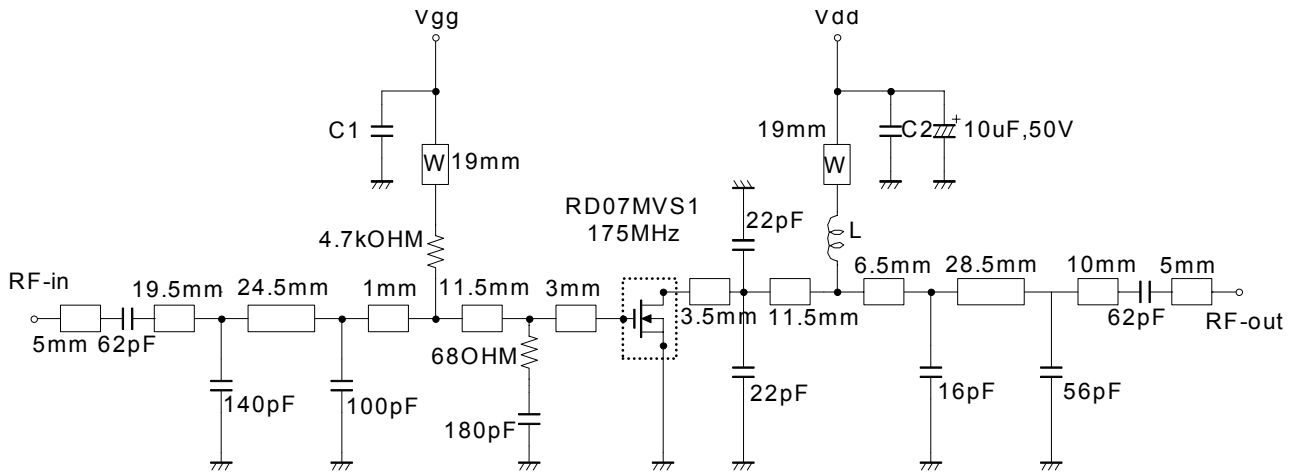

L: Enameled wire 7Turns, D:0.43mm, 2.46mm O.D
C1, C2: 1000pF, 0.022uF in parallel

Note: Board material- Teflon substrate
Micro strip line width=2.2mm/50OHM, er:2.7, t=0.8mm
W: line width=1.0mm

TEST CIRCUIT(f=520MHz)

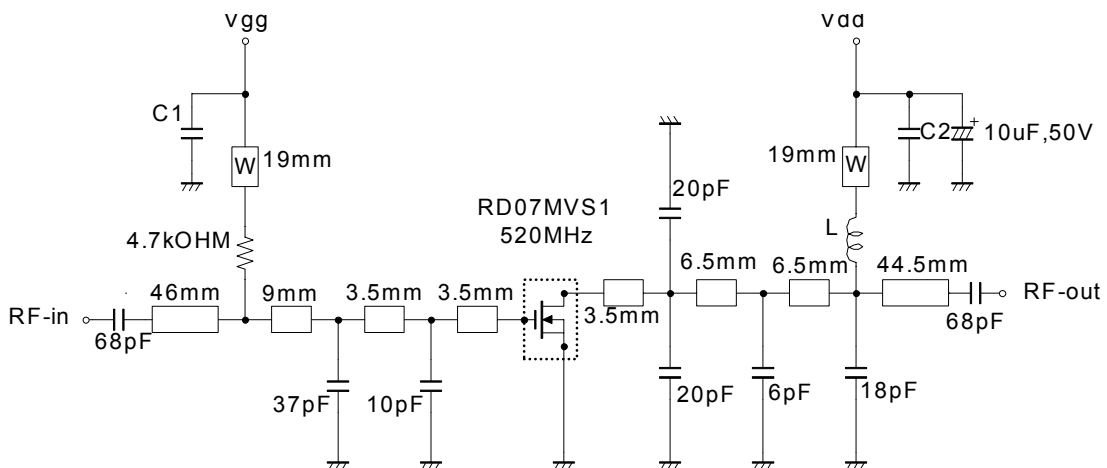

L: Enameled wire 5Turns, D:0.43mm, 2.46mm O.D
C1, C2: 1000pF, 0.022uF in parallel

Note: Board material- Teflon substrate
Micro strip line width=2.2mm/50OHM, er:2.7, t=0.8mm
W: line width=1.0mm

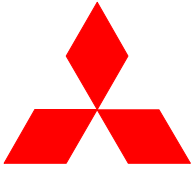

ELECTROSTATIC SENSITIVE DEVICE
OBSERVE HANDLING PRECAUTIONS

MITSUBISHI RF POWER MOS FET

RD07MVS1B

RoHS Compliance, Silicon MOSFET Power Transistor, 175MHz, 520MHz, 7W

INPUT/OUTPUT IMPEDANCE VS. FREQUENCY CHARACTERISTICS

175MHz Z_{in}^* Z_{out}^*
 $Z_o=10\Omega$

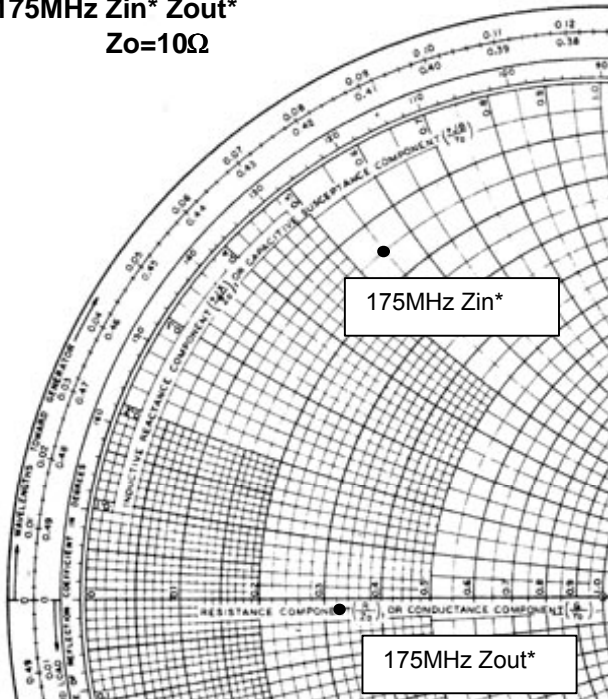

$V_{dd}=7.2V$, $I_{dq}=700mA(V_{gg} \text{ adj.})$, $P_{in}=0.28W$

$Z_{in}^*=1.55+j5.53$
 $Z_{out}^*=3.24-j0.26$

Z_{in}^* : Complex conjugate of input impedance
 Z_{out}^* : Complex conjugate of output impedance

520MHz Z_{in}^* Z_{out}^*
 $Z_o=10\Omega$

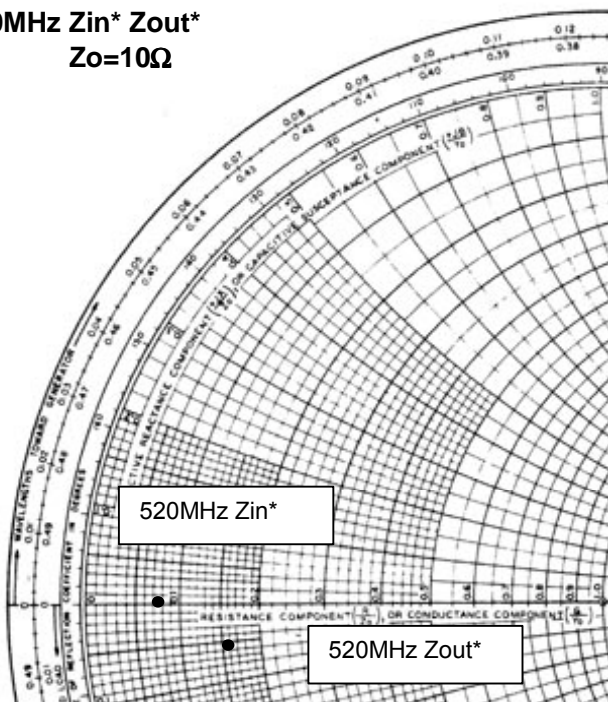

$V_{dd}=7.2V$, $I_{dq}=750mA(V_{gg} \text{ adj.})$, $P_{in}=0.7W$

$Z_{in}^*=0.76+j0.06$
 $Z_{out}^*=1.61-j0.52$

Z_{in}^* : Complex conjugate of input impedance
 Z_{out}^* : Complex conjugate of output impedance

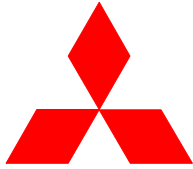

ELECTROSTATIC SENSITIVE DEVICE
OBSERVE HANDLING PRECAUTIONS

MITSUBISHI RF POWER MOS FET
RD07MVS1B

RoHS Compliance, Silicon MOSFET Power Transistor, 175MHz, 520MHz, 7W

RD07MVS1B S-PARAMETER DATA (@V_{dd}=7.2V, I_d=750mA)

Freq. [MHz]	S11		S21		S12		S22	
	(mag)	(ang)	(mag)	(ang)	(mag)	(ang)	(mag)	(ang)
100	0.881	-174.0	6.055	75.9	0.018	-14.2	0.767	-170.7
135	0.885	-175.5	4.358	68.8	0.017	-20.6	0.773	-172.2
150	0.888	-176.0	3.844	66.2	0.017	-23.4	0.774	-172.4
175	0.891	-176.6	3.207	62.8	0.016	-26.8	0.788	-172.4
200	0.896	-177.1	2.749	59.3	0.016	-29.8	0.810	-172.4
250	0.904	-178.0	2.069	51.8	0.015	-36.7	0.829	-173.0
300	0.914	-178.8	1.602	46.2	0.013	-42.2	0.842	-173.6
350	0.922	-179.7	1.288	40.5	0.012	-47.7	0.871	-174.6
400	0.929	179.6	1.043	35.7	0.011	-52.2	0.878	-175.3
450	0.934	178.8	0.864	31.8	0.009	-55.2	0.895	-176.3
500	0.939	178.0	0.724	27.7	0.008	-57.6	0.907	-177.1
520	0.941	177.8	0.678	26.4	0.008	-57.8	0.907	-177.4
527	0.941	177.7	0.660	26.0	0.007	-59.8	0.908	-177.4
550	0.944	177.4	0.616	24.7	0.007	-61.0	0.910	-177.8
600	0.947	176.7	0.529	21.7	0.006	-62.4	0.925	-178.8
650	0.950	176.1	0.458	19.1	0.005	-63.3	0.925	-179.3
700	0.953	175.5	0.401	16.8	0.005	-63.4	0.933	180.0
750	0.953	174.9	0.351	14.4	0.004	-63.4	0.939	179.4
800	0.956	174.5	0.314	12.6	0.003	-61.4	0.940	179.1
850	0.955	174.1	0.279	10.9	0.003	-59.7	0.944	178.3
900	0.958	173.6	0.250	9.1	0.002	-59.3	0.948	178.3
950	0.959	173.4	0.225	8.1	0.002	-54.8	0.947	177.7
1000	0.959	172.9	0.204	6.3	0.001	-47.5	0.952	177.2
1050	0.959	172.7	0.186	5.3	0.001	-34.8	0.951	177.2
1100	0.959	172.5	0.170	3.9	0.001	-14.2	0.952	176.5

RD07MVS1B S-PARAMETER DATA (@V_{dd}=12.5V, I_d=750mA)

Freq. [MHz]	S11		S21		S12		S22	
	(mag)	(ang)	(mag)	(ang)	(mag)	(ang)	(mag)	(ang)
100	0.880	-172.4	6.708	75.3	0.018	-13.9	0.726	-168.1
135	0.884	-174.2	4.812	67.7	0.017	-21.0	0.737	-169.4
150	0.886	-174.9	4.237	64.9	0.017	-23.8	0.742	-169.7
175	0.891	-175.5	3.523	61.2	0.016	-26.9	0.759	-169.7
200	0.897	-176.1	3.008	57.5	0.016	-30.8	0.784	-169.7
250	0.907	-177.2	2.249	49.7	0.014	-38.8	0.810	-170.5
300	0.916	-178.1	1.729	43.9	0.013	-43.0	0.829	-171.4
350	0.926	-179.2	1.383	38.2	0.012	-49.1	0.861	-172.5
400	0.932	179.9	1.114	33.3	0.010	-54.0	0.870	-173.4
450	0.938	179.1	0.918	29.3	0.009	-57.3	0.889	-174.6
500	0.943	178.3	0.769	25.4	0.008	-61.1	0.903	-175.7
520	0.944	178.0	0.716	24.0	0.007	-61.2	0.904	-176.0
527	0.944	177.9	0.698	23.6	0.007	-62.3	0.905	-176.0
550	0.946	177.5	0.651	22.3	0.007	-63.6	0.907	-176.5
600	0.950	176.8	0.557	19.3	0.006	-63.7	0.921	-177.6
650	0.952	176.3	0.480	16.7	0.005	-66.5	0.923	-178.1
700	0.954	175.5	0.420	14.5	0.004	-64.0	0.932	-179.0
750	0.955	175.0	0.368	12.1	0.004	-65.9	0.937	-179.7
800	0.957	174.6	0.326	10.3	0.003	-66.5	0.937	179.9
850	0.956	174.1	0.291	8.8	0.002	-62.7	0.943	179.2
900	0.958	173.7	0.260	7.0	0.002	-64.3	0.946	179.0
950	0.958	173.4	0.235	5.7	0.001	-62.3	0.947	178.5
1000	0.959	173.0	0.212	4.1	0.001	-54.8	0.952	177.9
1050	0.960	172.6	0.193	3.2	0.001	-27.4	0.950	178.0
1100	0.959	172.4	0.177	1.9	0.000	10.8	0.950	177.1



ELECTROSTATIC SENSITIVE DEVICE
OBSERVE HANDLING PRECAUTIONS

MITSUBISHI RF POWER MOS FET
RD07MVS1B

RoHS Compliance, Silicon MOSFET Power Transistor, 175MHz, 520MHz, 7W

—Keep safety first in your circuit designs! —

Mitsubishi Electric Corporation puts the maximum effort into making semiconductor products better and more reliable, but there is always the possibility that trouble may occur with them. Trouble with semiconductors may lead to personal injury, fire or property damage. Remember to give due consideration to safety when making your circuit designs, with appropriate measures such as (i) placement of substitutive, auxiliary circuits, (ii) use of non-flammable material or (iii) prevention against any malfunction or mishap.

warning !

Do not use the device at the exceeded the maximum rating condition. In case of plastic molded devices, the exceeded maximum rating condition may cause blowout, smoldering or catch fire of the molding resin due to extreme short current flow between the drain and the source of the device. These results causes in fire or injury.