

DATA SHEET

**PMBFJ308; PMBFJ309;
PMBFJ310**

**N-channel silicon field-effect
transistors**

Product specification
Supersedes data of April 1995
File under Discrete Semiconductors, SC07

1996 Sep 11

N-channel silicon field-effect transistors

PMBFJ308; PMBFJ309; PMBFJ310

FEATURES

- Low noise
- Interchangeability of drain and source connections
- High gain.

APPLICATIONS

- AM input stage in car radios
- VHF amplifiers
- Oscillators and mixers.

DESCRIPTION

N-channel symmetrical silicon junction field-effect transistors in a SOT23 package.

CAUTION

The device is supplied in an antistatic package. The gate-source input must be protected against static discharge during transport or handling.

PINNING - SOT23

PIN	SYMBOL	DESCRIPTION
1	s	source
2	d	drain
3	g	gate

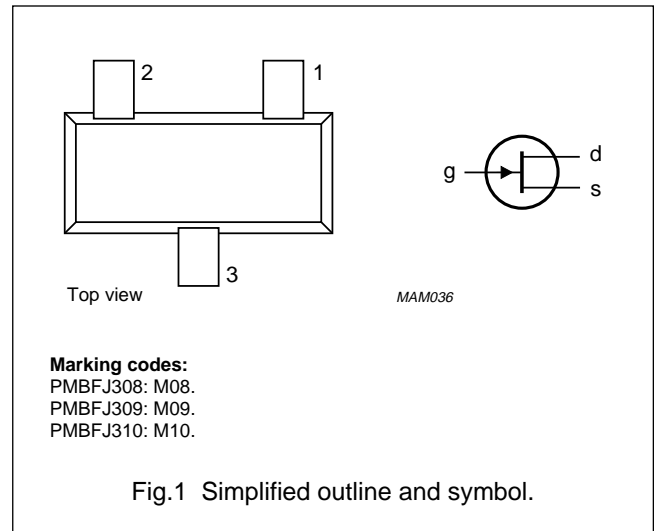

QUICK REFERENCE DATA

SYMBOL	PARAMETER	CONDITIONS	MIN.	MAX.	UNIT
V_{DS}	drain-source voltage		–	±25	V
V_{GSoff}	gate-source cut-off voltage	$V_{DS} = 10\text{ V}; I_D = 1\ \mu\text{A}$			
	PMBFJ308		–1	–6.5	V
	PMBFJ309		–1	–4	V
	PMBFJ310		–2	–6.5	V
I_{DSS}	drain current	$V_{GS} = 0; V_{DS} = 10\text{ V}$			
	PMBFJ308		12	60	mA
	PMBFJ309		12	30	mA
	PMBFJ310		24	60	mA
P_{tot}	total power dissipation	up to $T_{amb} = 25\text{ °C}$	–	250	mW
$ y_{fs} $	forward transfer admittance	$V_{DS} = 10\text{ V}; I_D = 10\text{ mA}$	10	–	mS

N-channel silicon field-effect transistors

PMBFJ308; PMBFJ309;
PMBFJ310

LIMITING VALUES

In accordance with the Absolute Maximum Rating System (IEC 134).

SYMBOL	PARAMETER	CONDITIONS	MIN.	MAX.	UNIT
V_{DS}	drain-source voltage		–	± 25	V
V_{GSO}	gate-source voltage	open drain	–	–25	V
V_{GDO}	gate-drain voltage	open source	–	–25	V
I_G	forward gate current (DC)		–	50	mA
P_{tot}	total power dissipation	up to $T_{amb} = 25\text{ }^\circ\text{C}$	–	250	mW
T_{stg}	storage temperature		–65	150	$^\circ\text{C}$
T_j	operating junction temperature		–	150	$^\circ\text{C}$

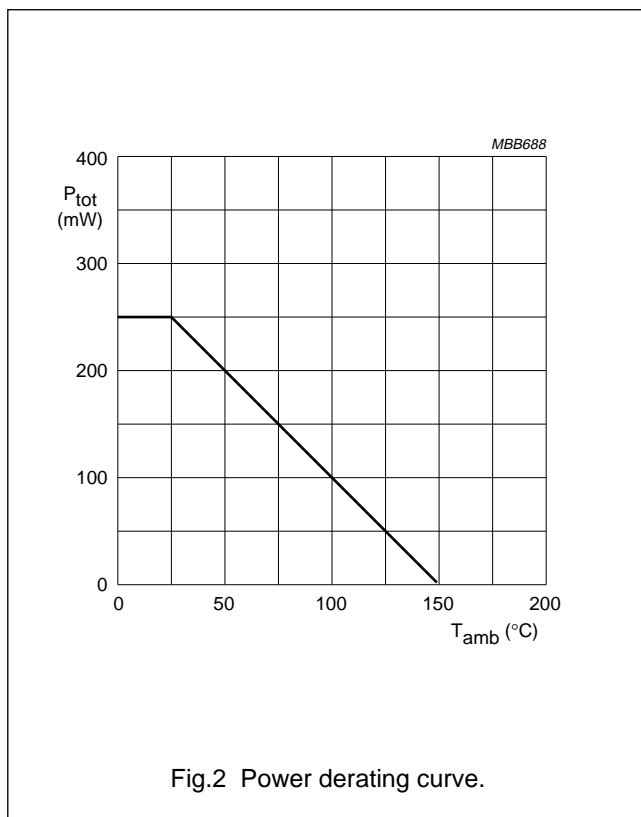

N-channel silicon field-effect transistors

PMBFJ308; PMBFJ309;
PMBFJ310

THERMAL CHARACTERISTICS

SYMBOL	PARAMETER	VALUE	UNIT
$R_{th\ j-a}$	thermal resistance from junction to ambient; note 1	500	K/W

Note

1. Device mounted on an FR4 printed-circuit board.

STATIC CHARACTERISTICS

$T_j = 25\text{ }^\circ\text{C}$; unless otherwise specified.

SYMBOL	PARAMETER	CONDITIONS	MIN.	TYP.	MAX.	UNIT
$V_{(BR)GSS}$	gate-source breakdown voltage	$I_G = -1\ \mu\text{A}$; $V_{DS} = 0$	-25	-	-	V
V_{GSoff}	gate-source cut-off voltage	$I_D = 1\ \mu\text{A}$; $V_{DS} = 10\ \text{V}$				V
	PMBFJ308		-1	-	-6.5	V
	PMBFJ309		-1	-	-4	V
	PMBFJ310		-2	-	-6.5	V
V_{GSS}	gate-source forward voltage	$I_G = 1\ \text{mA}$; $V_{DS} = 0$	-	-	1	V
I_{DSS}	drain current	$V_{DS} = 10\ \text{V}$; $V_{GS} = 0$				
	PMBFJ308		12	-	60	mA
	PMBFJ309		12	-	30	mA
	PMBFJ310		24	-	60	mA
I_{GSS}	gate leakage current	$V_{GS} = -15\ \text{V}$; $V_{DS} = 0$	-	-	-1	nA
R_{DSon}	drain-source on-state resistance	$V_{GS} = 0$; $V_{DS} = 100\ \text{mV}$	-	50	-	Ω
$ y_{fs} $	forward transfer admittance	$I_D = 10\ \text{mA}$; $V_{DS} = 10\ \text{V}$	10	-	-	mS
$ y_{os} $	common source output admittance	$I_D = 10\ \text{mA}$; $V_{DS} = 10\ \text{V}$	-	-	250	μS

N-channel silicon field-effect transistors

PMBFJ308; PMBFJ309;
PMBFJ310

DYNAMIC CHARACTERISTICS

$T_j = 25\text{ }^\circ\text{C}$; unless otherwise specified.

SYMBOL	PARAMETER	CONDITIONS	TYP.	MAX.	UNIT
C_{is}	input capacitance	$V_{DS} = 10\text{ V}; V_{GS} = -10\text{ V}; f = 1\text{ MHz}$	3	5	pF
		$V_{DS} = 10\text{ V}; V_{GS} = 0; T_{amb} = 25\text{ }^\circ\text{C}$	6	–	pF
C_{rs}	reverse transfer capacitance	$V_{DS} = 0; V_{GS} = -10\text{ V}; f = 1\text{ MHz}$	1.3	2.5	pF
g_{is}	common source input conductance	$V_{DS} = 10\text{ V}; I_D = 10\text{ mA}; f = 100\text{ MHz}$	200	–	μS
		$V_{DS} = 10\text{ V}; I_D = 10\text{ mA}; f = 450\text{ MHz}$	3	–	mS
g_{fs}	common source transfer conductance	$V_{DS} = 10\text{ V}; I_D = 10\text{ mA}; f = 100\text{ MHz}$	13	–	mS
		$V_{DS} = 10\text{ V}; I_D = 10\text{ mA}; f = 450\text{ MHz}$	12	–	mS
g_{rs}	common source reverse conductance	$V_{DS} = 10\text{ V}; I_D = 10\text{ mA}; f = 100\text{ MHz}$	–30	–	μS
		$V_{DS} = 10\text{ V}; I_D = 10\text{ mA}; f = 450\text{ MHz}$	–450	–	μS
g_{os}	common source output conductance	$V_{DS} = 10\text{ V}; I_D = 10\text{ mA}; f = 100\text{ MHz}$	150	–	μS
		$V_{DS} = 10\text{ V}; I_D = 10\text{ mA}; f = 450\text{ MHz}$	400	–	μS
V_n	equivalent input noise voltage	$V_{DS} = 10\text{ V}; I_D = 10\text{ mA}; f = 100\text{ Hz}$	6	–	nV/ $\sqrt{\text{Hz}}$

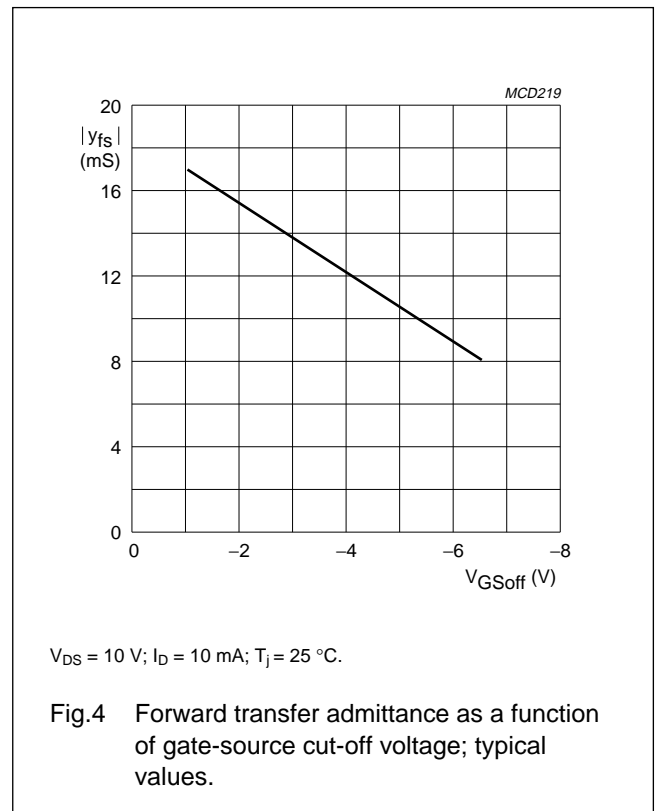
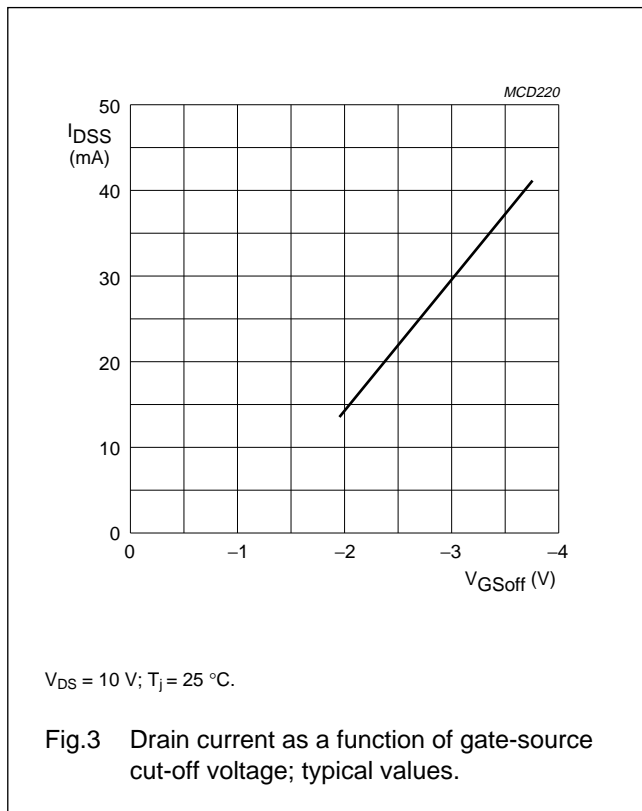

N-channel silicon field-effect transistors

PMBFJ308; PMBFJ309;
PMBFJ310

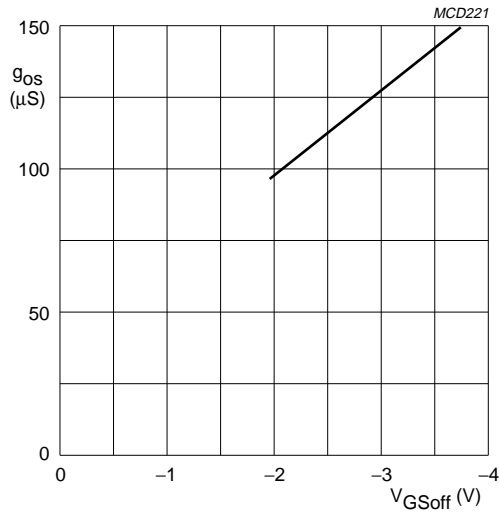

$V_{DS} = 10 \text{ V}; I_D = 10 \text{ mA}; T_j = 25 \text{ }^\circ\text{C}.$

Fig.5 Common-source output conductance as a function of gate-source cut-off voltage; typical values.

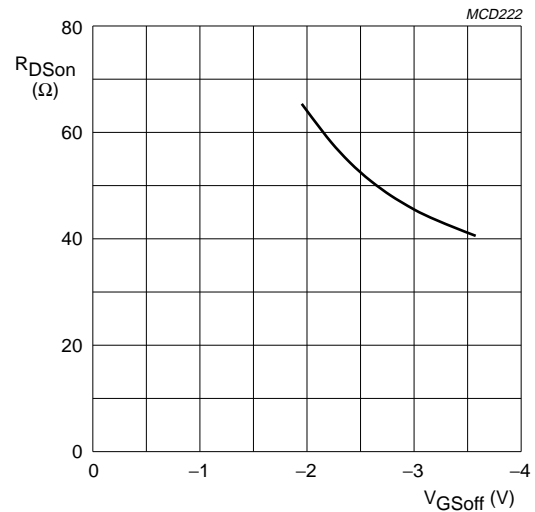

$V_{DS} = 100 \text{ mV}; V_{GS} = 0; T_j = 25 \text{ }^\circ\text{C}.$

Fig.6 Drain-source on-state resistance as a function of gate-source cut-off voltage; typical values.

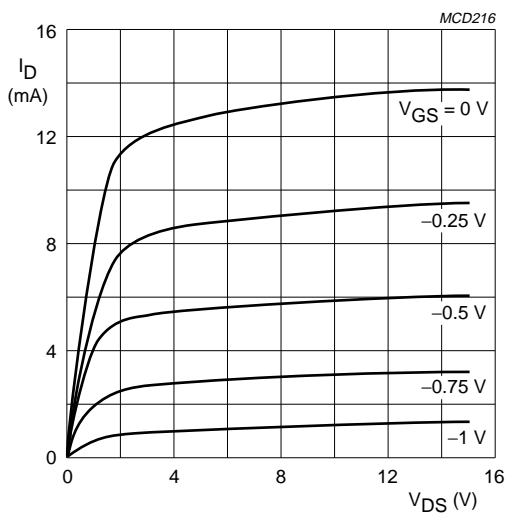

$T_j = 25 \text{ }^\circ\text{C}.$

Fig.7 Typical output characteristics; PMBFJ308.

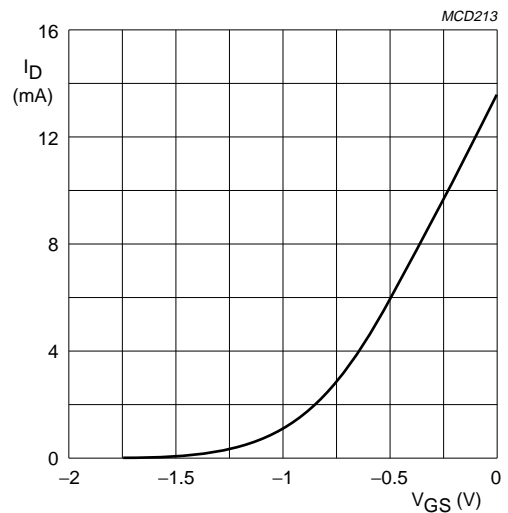

$V_{DS} = 10 \text{ V}; T_j = 25 \text{ }^\circ\text{C}.$

Fig.8 Typical transfer characteristics; PMBFJ308.

N-channel silicon field-effect transistors

PMBFJ308; PMBFJ309;
PMBFJ310

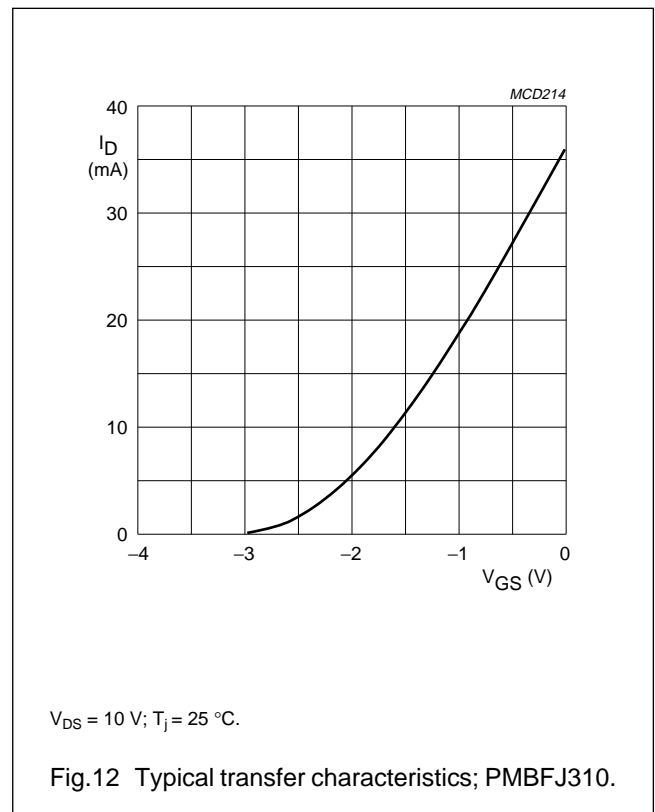
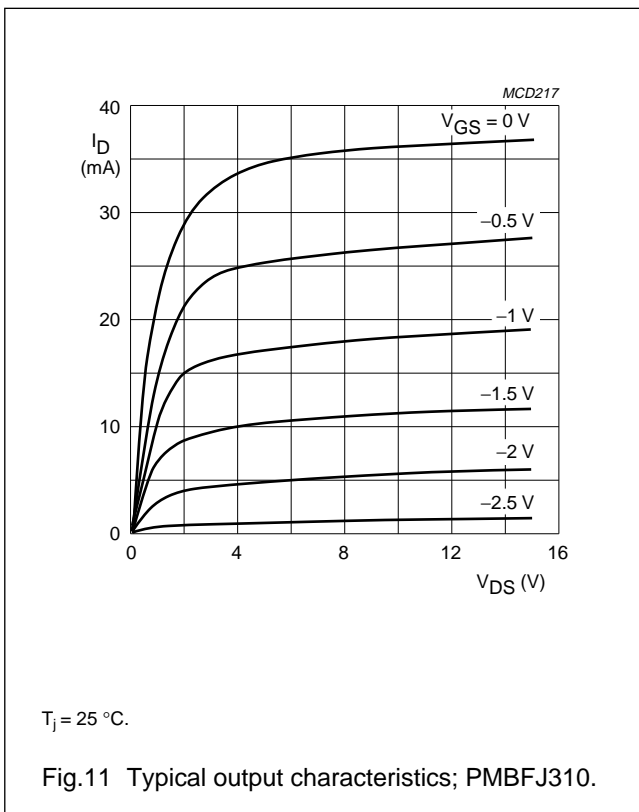
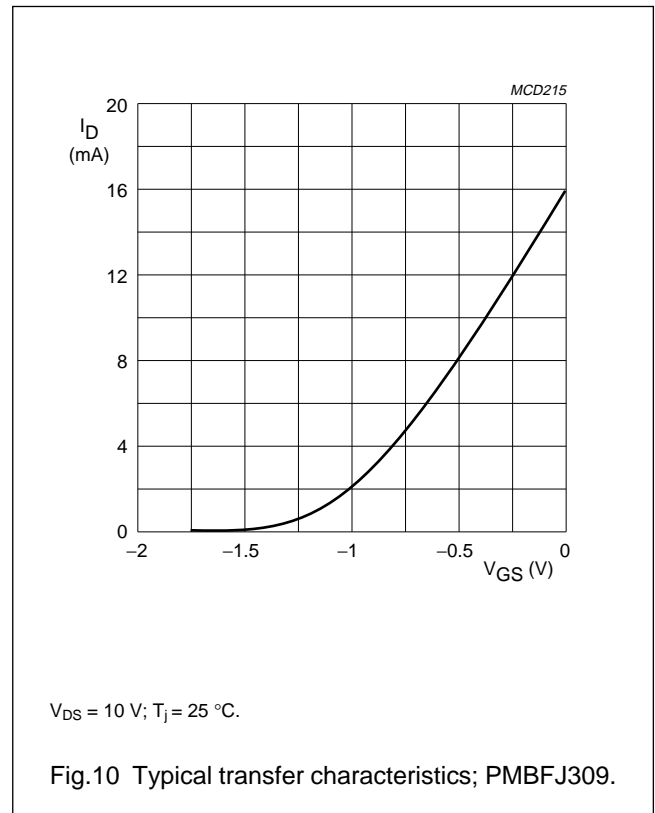
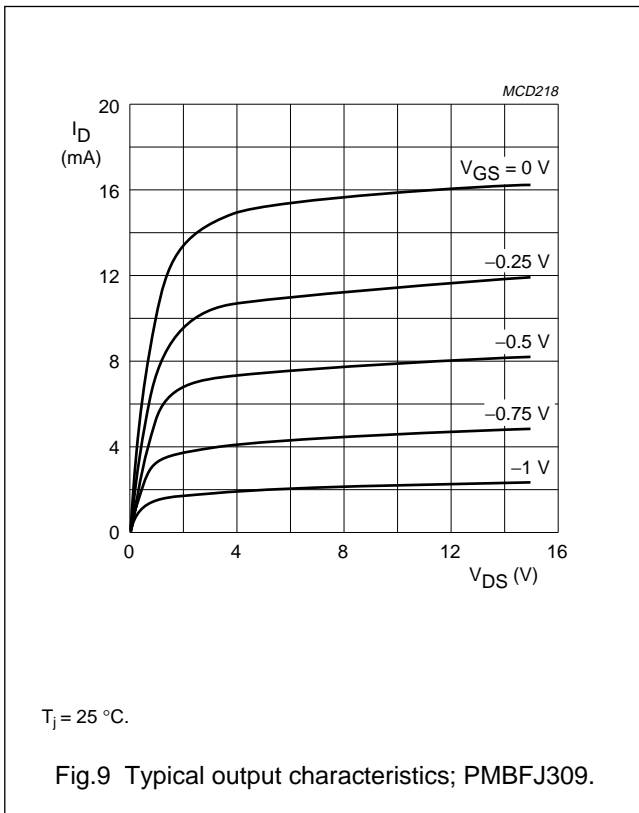

N-channel silicon field-effect transistors

PMBFJ308; PMBFJ309;
PMBFJ310

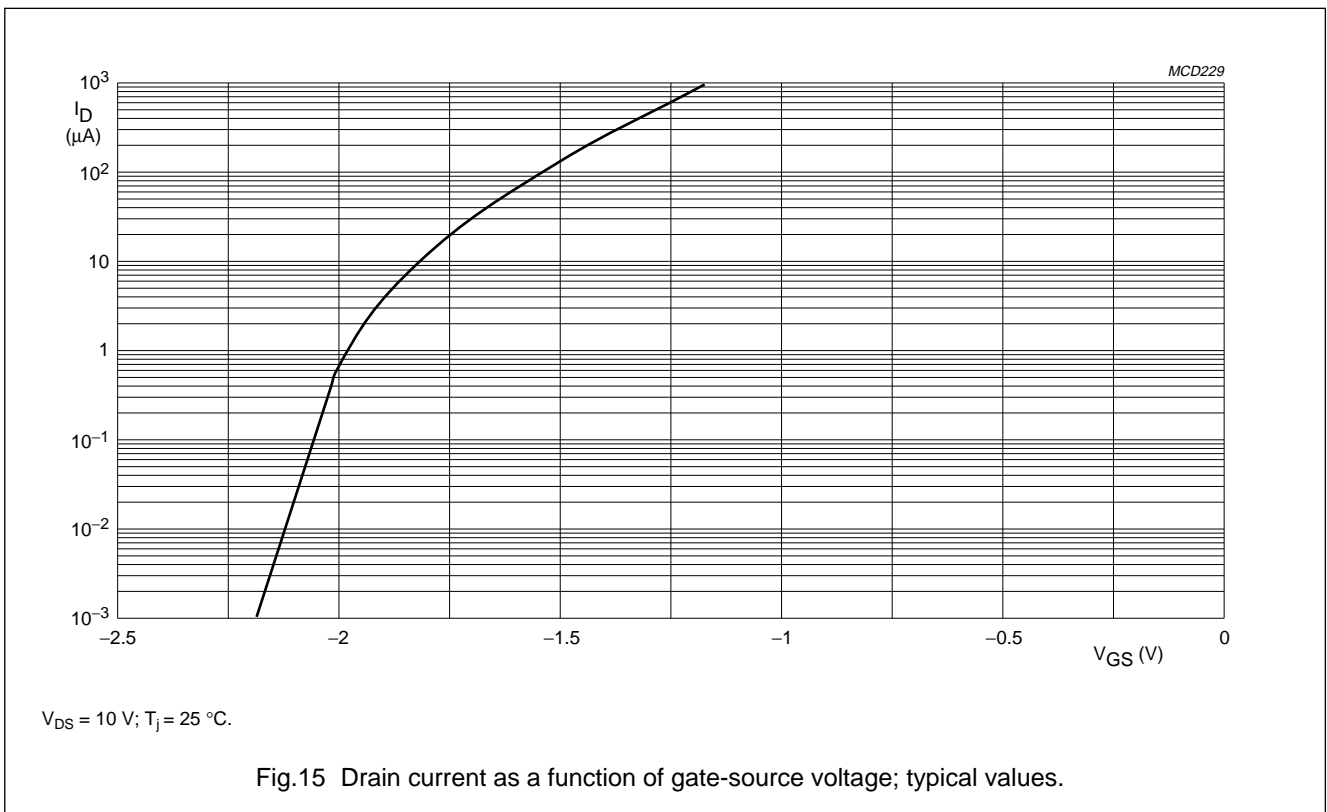
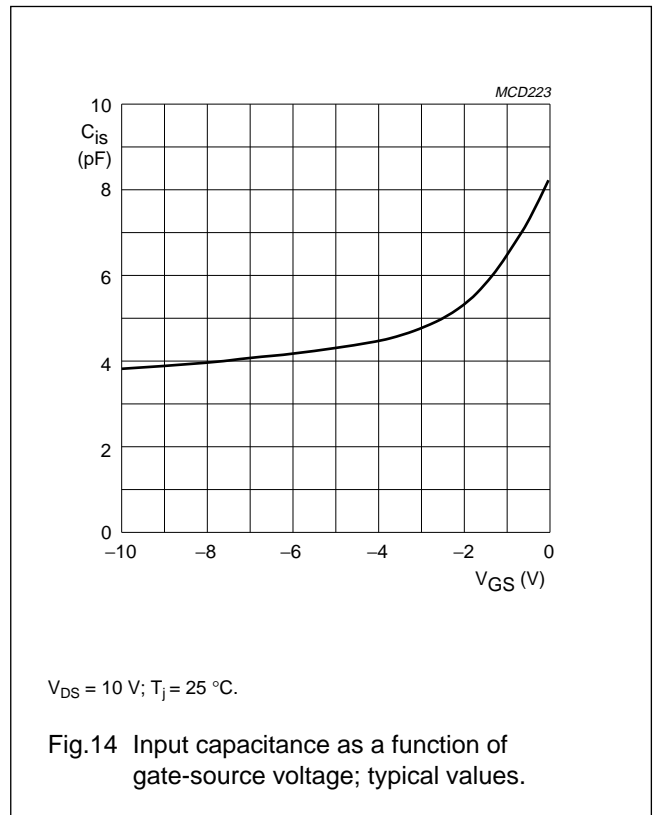
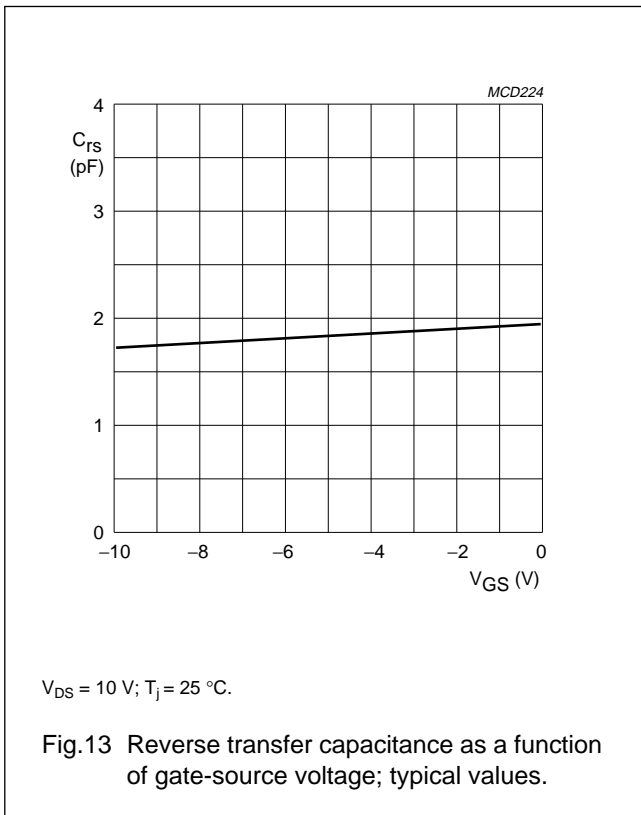

N-channel silicon field-effect transistors

PMBFJ308; PMBFJ309;
PMBFJ310

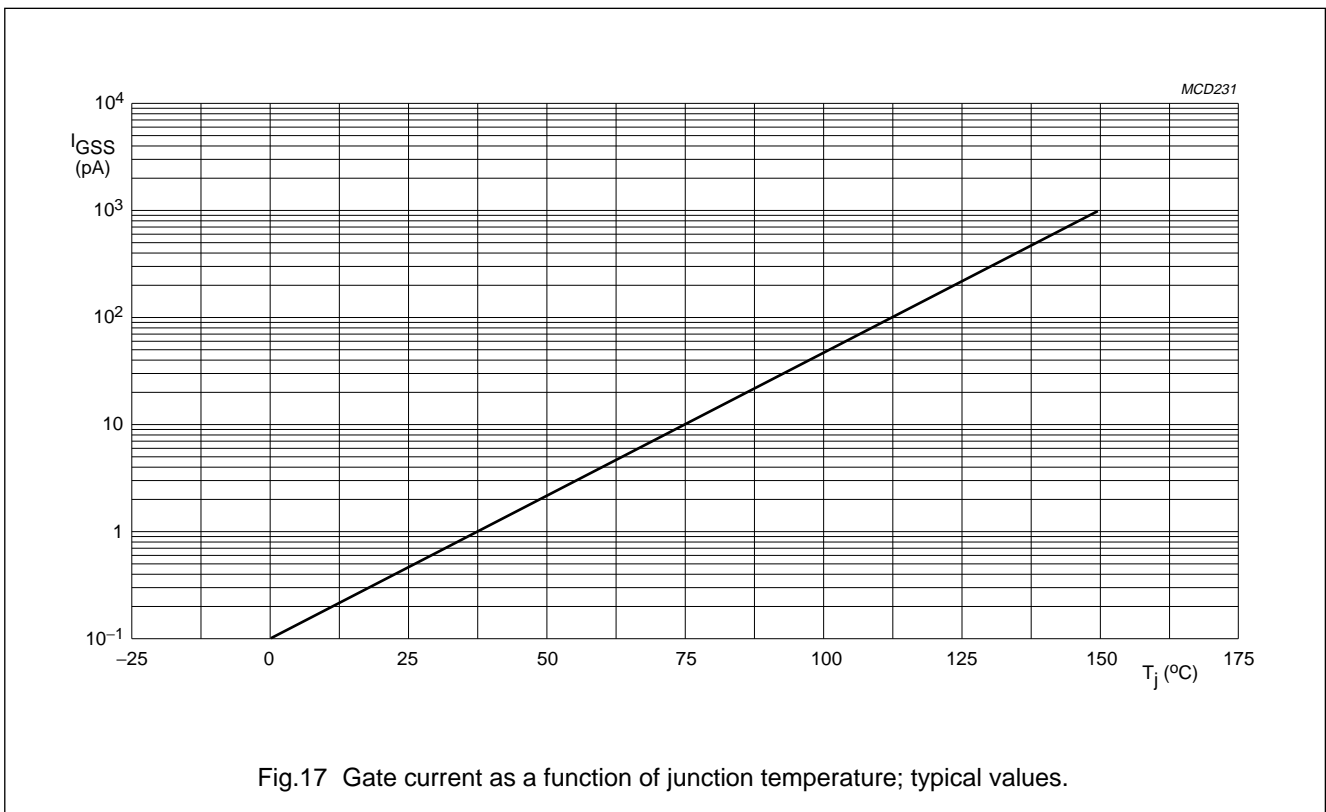
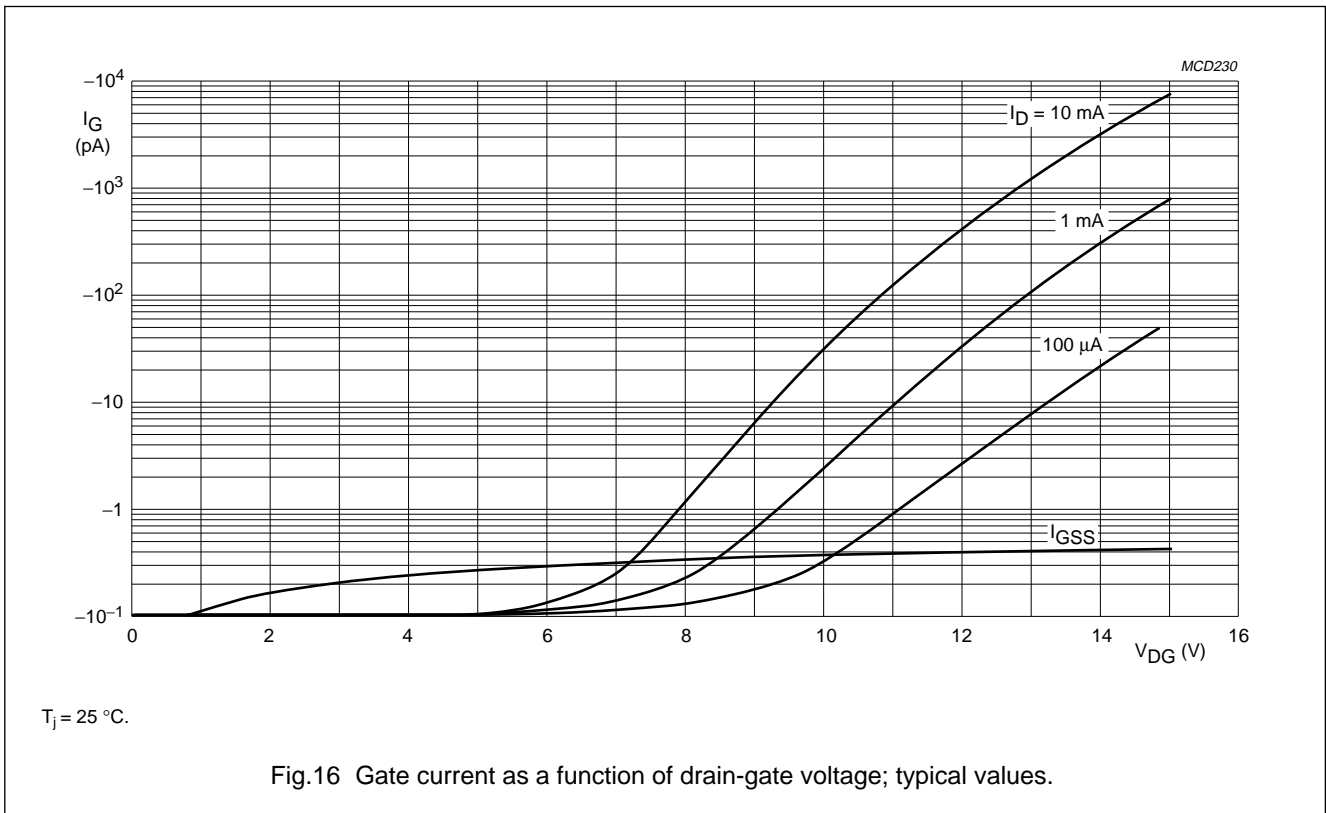

N-channel silicon field-effect transistors

PMBFJ308; PMBFJ309;
PMBFJ310

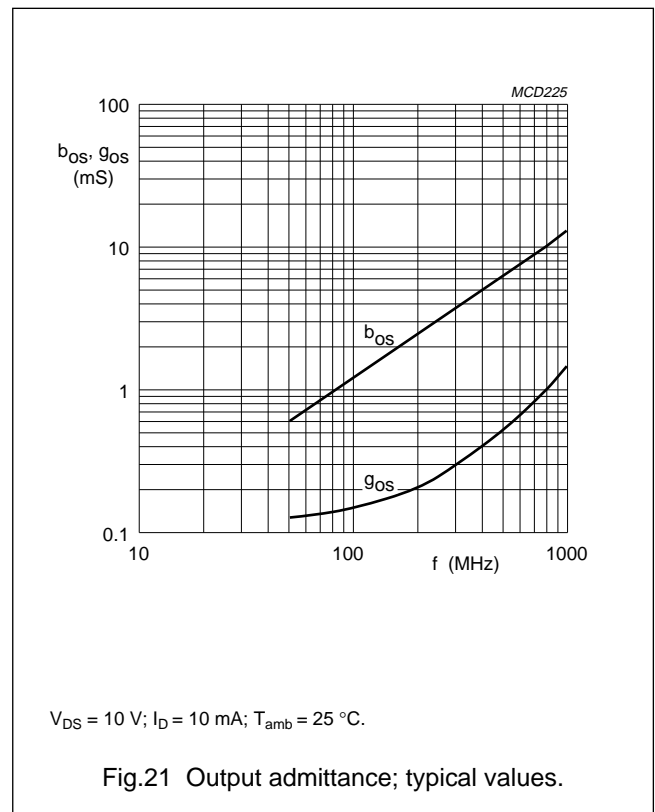
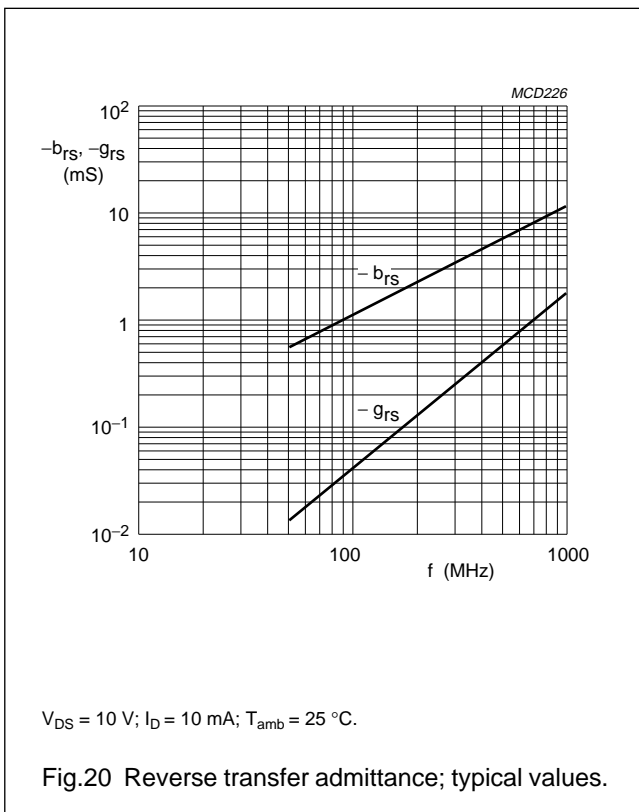
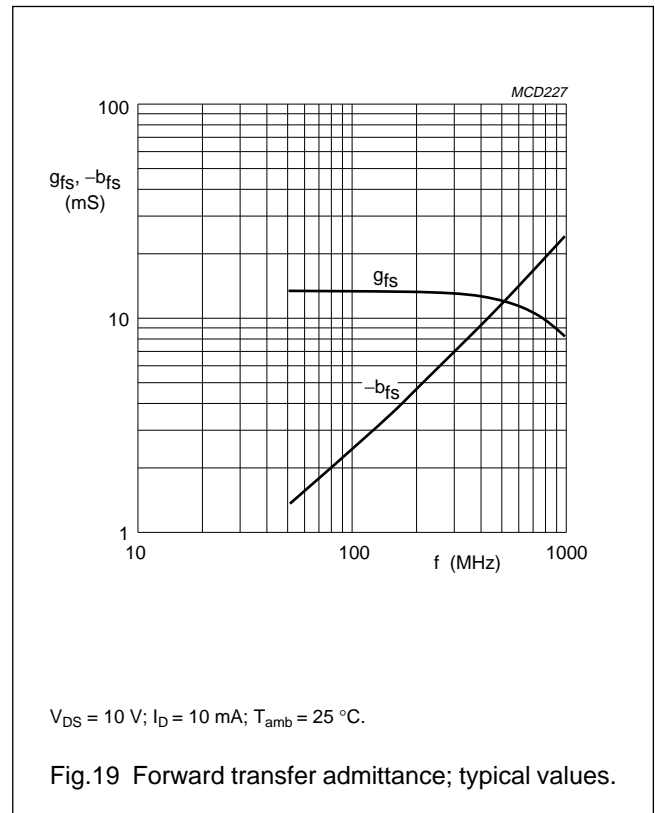
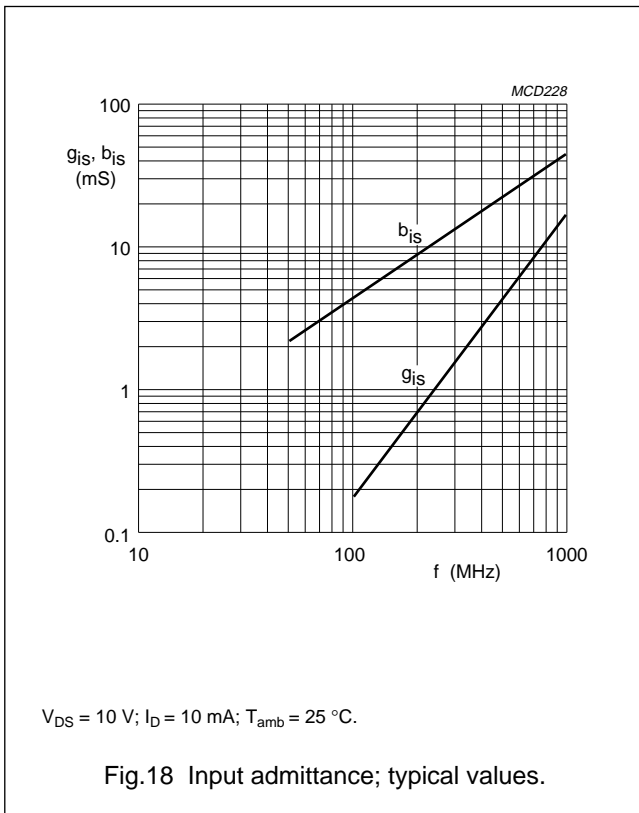

N-channel silicon field-effect transistors

PMBFJ308; PMBFJ309;
PMBFJ310

PACKAGE OUTLINE

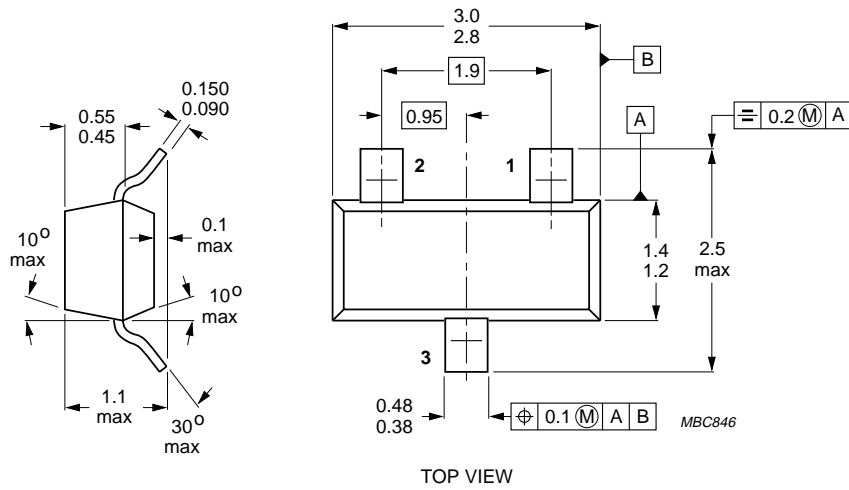

Dimensions in mm.

Fig.22 SOT 23.

N-channel silicon field-effect transistors

PMBFJ308; PMBFJ309;
PMBFJ310**DEFINITIONS**

Data Sheet Status	
Objective specification	This data sheet contains target or goal specifications for product development.
Preliminary specification	This data sheet contains preliminary data; supplementary data may be published later.
Product specification	This data sheet contains final product specifications.
Limiting values	
Limiting values given are in accordance with the Absolute Maximum Rating System (IEC 134). Stress above one or more of the limiting values may cause permanent damage to the device. These are stress ratings only and operation of the device at these or at any other conditions above those given in the Characteristics sections of the specification is not implied. Exposure to limiting values for extended periods may affect device reliability.	
Application information	
Where application information is given, it is advisory and does not form part of the specification.	

LIFE SUPPORT APPLICATIONS

These products are not designed for use in life support appliances, devices, or systems where malfunction of these products can reasonably be expected to result in personal injury. Philips customers using or selling these products for use in such applications do so at their own risk and agree to fully indemnify Philips for any damages resulting from such improper use or sale.