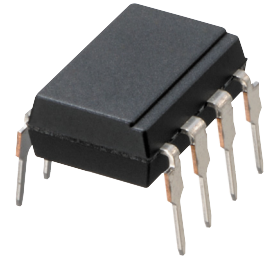


# PC925L0NSZ0F Series

High Speed, 2.5A Output,  
Gate Drive DIP 8 pin  
\*OPIC Photocoupler



## ■ Description

**PC925L0NSZ0F Series** contains a LED optically coupled to an OPIC chip.

It is packaged in a 8 pin DIP, available in SMT gullwing lead form option.

Peak output current is 2.5A, Input-output isolation voltage(rms) is 5kV and High speed response ( $t_{PHL}$ ,  $t_{PLH}$  : MAX. 0.5 $\mu$ s).

## ■ Features

1. 8 pin DIP package
2. Double transfer mold package  
(Ideal for Flow Soldering)
3. Built-in direct drive circuit for MOSFET / IGBT drive  
( $I_{O(peak)}$  : 2.5A)
4. High speed response ( $t_{PHL}$ ,  $t_{PLH}$  : MAX. 0.5 $\mu$ s)
5. Wide operating supply voltage range  
( $V_{CC}$ =15 to 30 V)
6. High noise immunity due to high instantaneous common mode rejection voltage ( $CM_H$  : MIN. -15kV/ $\mu$ s,  $CM_L$  : MIN. 15kV/ $\mu$ s)
7. Long creepage distance type (wide lead-form type only : MIN. 8mm)
8. High isolation voltage between input and output  
( $V_{iso(rms)}$  : 5kV)
9. Lead-free and RoHS directive compliant

## ■ Agency approvals/Compliance

1. Recognized by UL1577 (Double protection isolation), file No. E64380 (as model No. **PC925L**)
2. Package resin : UL flammability grade (94V-0)

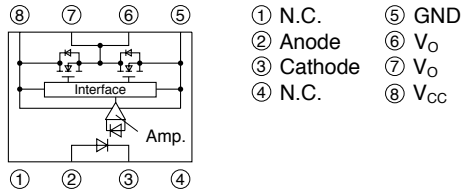
## ■ Applications

1. IGBT/MOSFET gate drive for inverter control

\* "OPIC"(Optical IC) is a trademark of the SHARP Corporation. An OPIC consists of a light-detecting element and a signal-processing circuit integrated onto a single chip.

Notice The content of data sheet is subject to change without prior notice.  
In the absence of confirmation by device specification sheets, SHARP takes no responsibility for any defects that may occur in equipment using any SHARP devices shown in catalogs, data books, etc. Contact SHARP in order to obtain the latest device specification sheets before using any SHARP device.

## Internal Connection Diagram



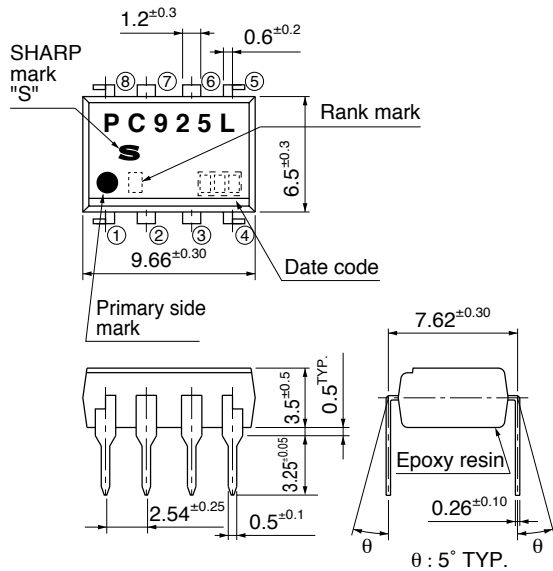
## Truth table

Input	V <sub>O</sub> Terminal output	Tr1	Tr2
ON	High level	ON	OFF
OFF	Low level	OFF	ON

## Outline Dimensions

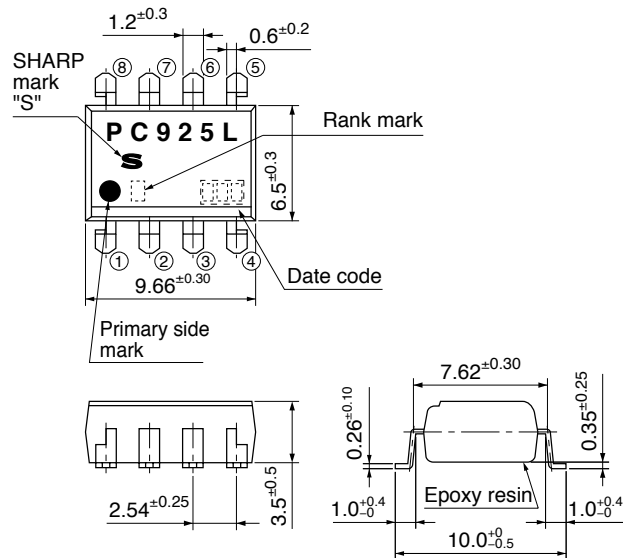
(Unit : mm)

### 1. Through-Hole [ex. PC925L0NSZ0F]



Product mass : approx. 0.55g

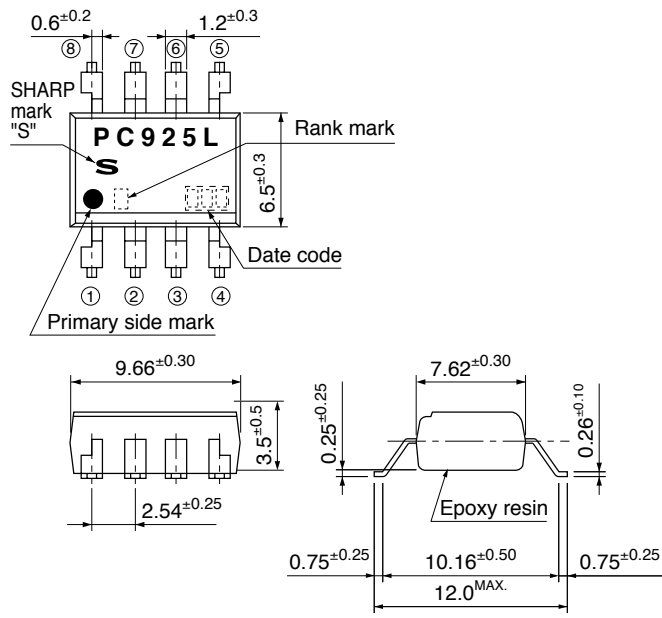
### 2. SMT Gullwing Lead-Form [ex. PC925L0NIP0F]



Product mass : approx. 0.51g

(Unit : mm)

3. Wide SMT Gullwing Lead-Form  
[ex. PC925L0NUP0F]



Product mass : approx. 0.55g





Plating material : Pd (Au flash)

## Date code (3 digit)

1st digit				2nd digit		3rd digit	
Year of production				Month of production		Week of production	
A.D.	Mark	A.D.	Mark	Month	Mark	Week	Mark
1990	A	2002	P	January	1	1st	1
1991	B	2003	R	February	2	2nd	2
1992	C	2004	S	March	3	3rd	3
1993	D	2005	T	April	4	4th	4
1994	E	2006	U	May	5	5, 6th	5
1995	F	2007	V	June	6		
1996	H	2008	W	July	7		
1997	J	2009	X	August	8		
1998	K	2010	A	September	9		
1999	L	2011	B	October	O		
2000	M	2012	C	November	N		
2001	N	:	:	December	D		

repeats in a 20 year cycle

## Factory identification mark

Factory identification Mark	Country of origin
no mark	Japan
	
 or 	Indonesia
	China

\* This factory marking is for identification purpose only.  
Please contact the local SHARP sales representative to see the actual status of the production.

## Rank mark

With or without.

## ■ Absolute Maximum Ratings (T<sub>a</sub>=25°C)

Parameter	Symbol	Rating	Unit
Input	*1 Forward current	I <sub>F</sub>	25 mA
	Reverse voltage	V <sub>R</sub>	5 V
	*2 Peak forward current	I <sub>FM</sub>	1 A
Output	Supply voltage	V <sub>CC</sub>	35 V
	*3 Peak output current	I <sub>O(PEAK)</sub>	2.5 A
	Output voltage	V <sub>O</sub>	V <sub>CC</sub> V
	*4 Output power dissipation	P <sub>O</sub>	250 mW
*5 Total power dissipation	P <sub>tot</sub>	295 mW	
*6 Isolation voltage	V <sub>iso(rms)</sub>	5 kV	
Operating temperature	T <sub>opr</sub>	-40 to +100	°C
Storage temperature	T <sub>stg</sub>	-55 to +125	°C
*7 Soldering temperature	T <sub>sol</sub>	270	°C

\*1 When ambient temperature goes above 70°C, the power dissipation goes down at 0.3mA/°C (Refer to Fig.10).

\*2 Pulse width ≤ 1μs, 300pps

\*3 Pulse width ≤ 10μs, Duty ratio : 0.002

\*4 When ambient temperature goes above 70°C, the power dissipation goes down at 4.8mA/°C (Refer to Fig.11).

\*5 When ambient temperature goes above 70°C, the power dissipation goes down at 5.4mA/°C (Refer to Fig.12).

\*6 AC for 1min, 40 to 60%RH, f=60Hz

\*7 For 10s

### ■ Electro-optical Characteristics \*8

(Unless otherwise specified :  $T_a = -40$  to  $+100^\circ\text{C}$ ,  $I_{F(ON)} = 7$  to  $16\text{mA}$ ,  $V_{CC} = 15$  to  $30\text{V}$ ,  $V_{F(OFF)} = -3\text{V}$  to  $0.8\text{V}$ )

	Parameter	Symbol	Condition	MIN.	*13 TYP.	MAX.	Unit	
Input	Forward voltage	$V_F$	$I_F = 10\text{mA}$	1.2	-	1.8	V	
	Reverse current	$I_R$	$V_R = 5\text{V}$	-	-	10	$\mu\text{A}$	
	Terminal capacitance	$C_t$	$T_a = 25^\circ\text{C}$ , $V = 0$ , $f = 1\text{MHz}$	-	60	150	pF	
Output	High level output current	$I_{OH}$	*8 $V_O = (V_{CC} - 4\text{V})$ , $I_{F(ON)}$	0.5	1.5	-	A	
			*9 $V_O = (V_{CC} - 15\text{V})$ , $I_{F(ON)}$	2	-	-	A	
	Low level output current	$I_{OL}$	*8 $V_O = 2.5\text{V}$ , $V_{F(OFF)}$	0.5	1.5	-	A	
			*9 $V_O = 15\text{V}$ , $V_{F(OFF)}$	2	-	-	A	
	High level output voltage	$V_{OH}$	$I_O = -0.1\text{A}$ , $I_{F(ON)}$	$V_{CC} - 4$	$V_{CC} - 3$	-	V	
	Low level output voltage	$V_{OL}$	$I_O = 0.1\text{A}$ , $V_{F(OFF)}$	-	0.1	0.5	V	
	*10 High level supply current	$I_{CCH}$	$I_{F(ON)}$	-	2.5	5	mA	
	*10 Low level supply current	$I_{CCL}$	$V_{F(OFF)}$	-	2.5	5	mA	
	UVLO threshold	$V_{UVLO+}$	$V_O > 5\text{V}$ , $I_F = 10\text{mA}$	11	12.3	13.5	V	
		$V_{UVLO-}$		9.5	10.7	12	V	
UVLO Hysteresis	$UVLO_{HYS}$		-	1.6	-	V		
Transfer characteristics	*11 "Low→High" threshold input current	$I_{FLH}$	$V_O > 5\text{V}$ , $I_O = 0$	-	-	5	mA	
	Isolation resistance	$R_{ISO}$	$T_a = 25^\circ\text{C}$ , $DC = 500\text{V}$ , 40 to 60%RH	$5 \times 10^{10}$	$10^{11}$	-	$\Omega$	
	Response time	"Low→High" propagation time	$t_{PLH}$	$R_G = 10\Omega$ , $C_G = 10\text{nF}$ , $f = 10\text{kHz}$ , Duty ratio 50%	0.1	0.3	0.5	$\mu\text{s}$
		"High→Low" propagation time	$t_{PHL}$		0.1	0.3	0.5	$\mu\text{s}$
		*12 Distortion of pulse width	$\Delta t_w$		-	-	0.3	$\mu\text{s}$
		Propagation delay skew	$t_{PSK}$		-0.35	-	0.35	$\mu\text{s}$
		Rise time	$t_r$		-	0.1	-	$\mu\text{s}$
		Fall time	$t_f$		-	0.1	-	$\mu\text{s}$
		UVLO Turn on delay	$t_{UVLO ON}$		$V_O > 5\text{V}$ , $I_F = 10\text{mA}$	-	0.8	-
	UVLO Turn off delay	$t_{UVLO OFF}$	$V_O > 5\text{V}$ , $I_F = 10\text{mA}$	-	0.6	-	$\mu\text{s}$	
Instantaneous common mode rejection voltage (High level output)	$ CM_H $	$T_a = 25^\circ\text{C}$ , $V_{CM} = 1.5\text{kV(p-p)}$ , $I_F = 10$ to $16\text{mA}$ , $V_{CC} = 30\text{V}$ , $V_{OH} > 15\text{V}$	15	-	-	$\text{kV}/\mu\text{s}$		
Instantaneous common mode rejection voltage (Low level output)	$ CM_L $	$T_a = 25^\circ\text{C}$ , $V_{CM} = 1.5\text{kV(p-p)}$ , $V_F = 0$ , $V_{CC} = 30\text{V}$ , $V_{OL} < 1\text{V}$	15	-	-	$\text{kV}/\mu\text{s}$		

\*7 It shall connect a by-pass capacitor of  $0.1\mu\text{F}$  or more between  $V_{CC}$  (Pin No. 8) and GND (Pin No. 5) near the device, when it measures the transfer characteristics and the output side characteristics.

\*8 Pulse width  $\leq 50\mu\text{s}$ , Duty ratio : 0.005

\*9 Pulse width  $\leq 10\mu\text{s}$ , Duty ratio : 0.002

\*10 Output pin is open.

\*11  $I_{FLH}$  is the value of forward current when output becomes from "L" to "H"

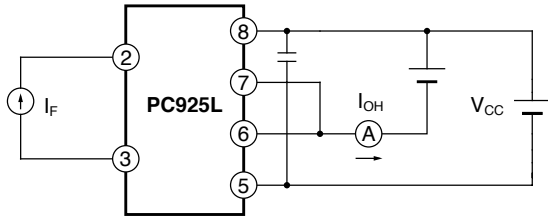
\*12 Distortion of pulse width  $\Delta t_w = |t_{PHL} - t_{PLH}|$

\*13 All typical values are at  $T_a = 25^\circ\text{C}$ ,  $V_{CC} = 30\text{V}$

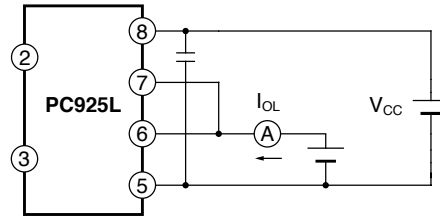
**■ Model Line-up**

Lead Form	Through-Hole	SMT Gullwing	Wide SMT Gullwing
Package	Sleeve	Taping	
	50 pcs/sleeve	1 000 pcs/reel	
Model No.	<b>PC925L0NSZ0F</b>	<b>PC925L0NIP0F</b>	<b>PC925L0NUP0F</b>

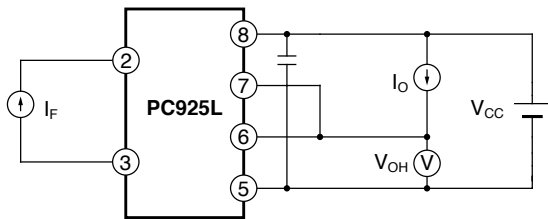
**Fig.1 Test Circuit for High Level Output Current**



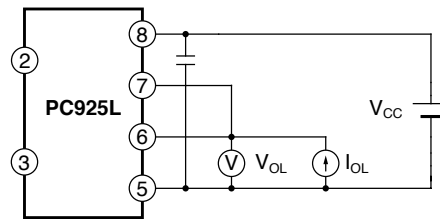
**Fig.2 Test Circuit for Low Level Output Current**



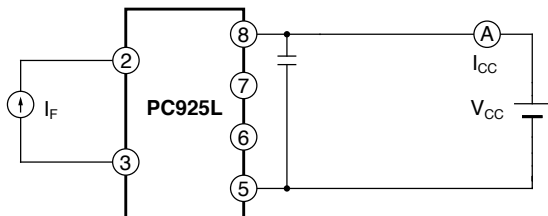
**Fig.3 Test Circuit for High Level Output Voltage**



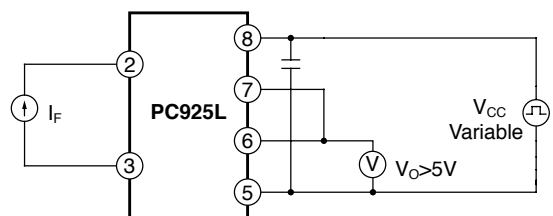
**Fig.4 Test Circuit for Low Level Output Voltage**



**Fig.5 Test Circuit for High Level / Low Level Supply Current**

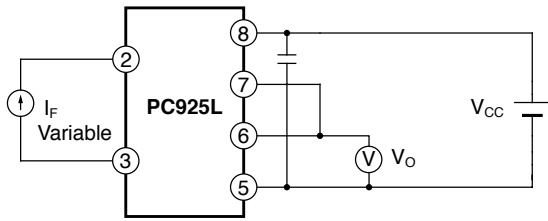


**Fig.6 Test Circuit for UVLO Threshold**

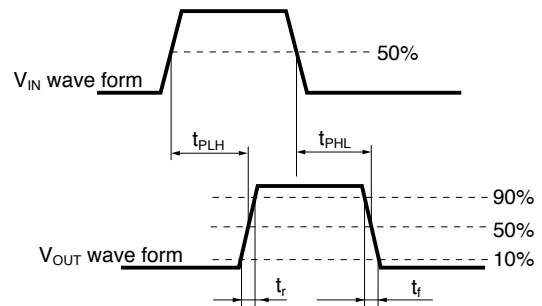
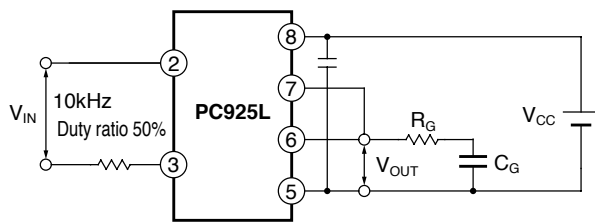




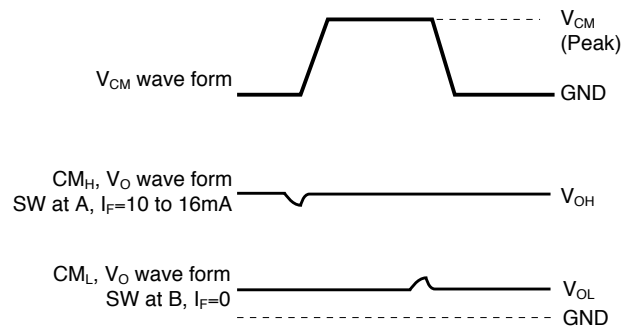
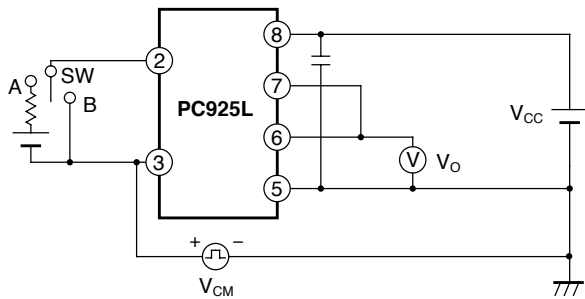
**Fig.7 Test Circuit for "Low→High" Input Threshold Current**



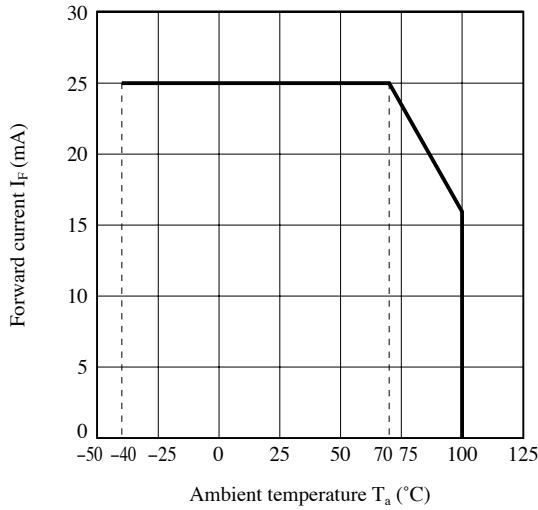
**Fig.8 Test Circuit for Response Time**



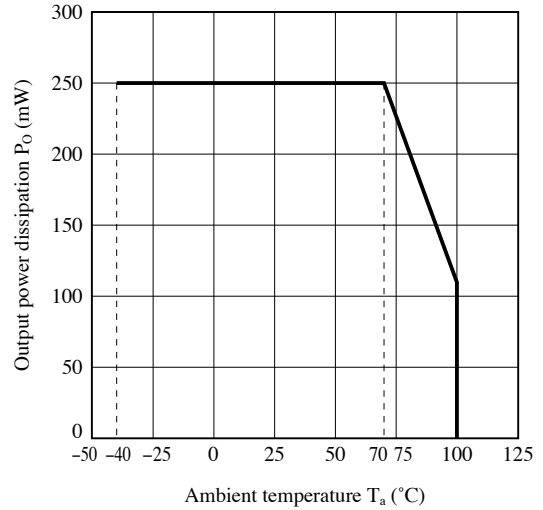
**Fig.9 Test Circuit for Instantaneous Common Mode Rejection Voltage**



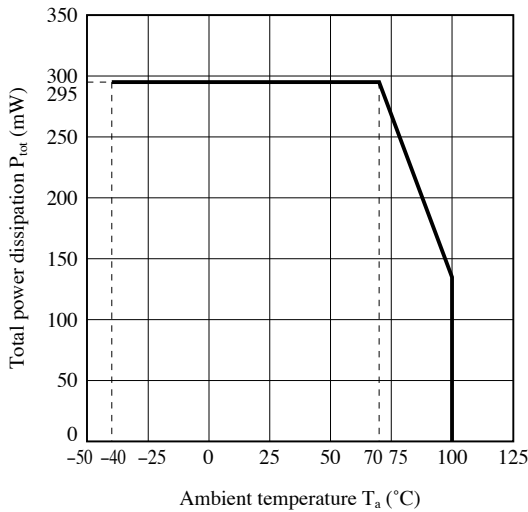
**Fig.10 Forward Current vs. Ambient Temperature**



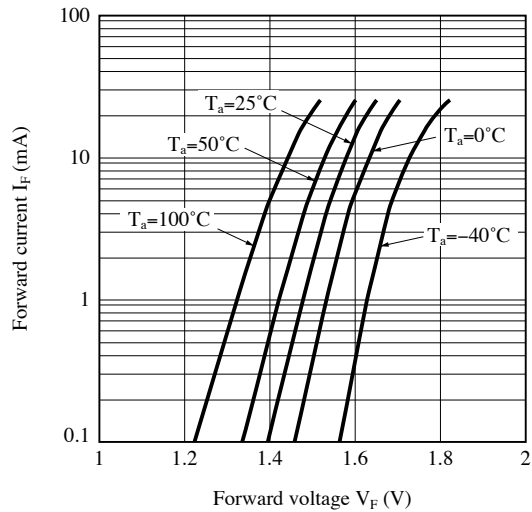
**Fig.11 Power Dissipation vs. Ambient Temperature**



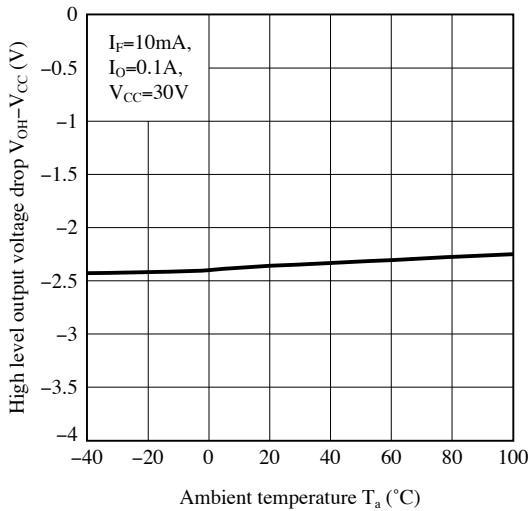
**Fig.12 Total Power Dissipation vs. Ambient Temperature**



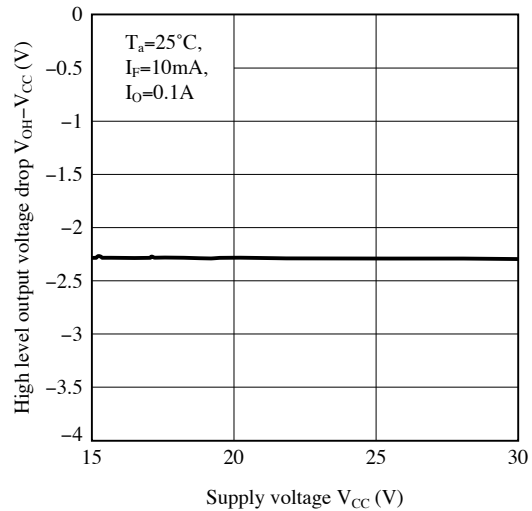
**Fig.13 Forward Current vs. Forward Voltage**



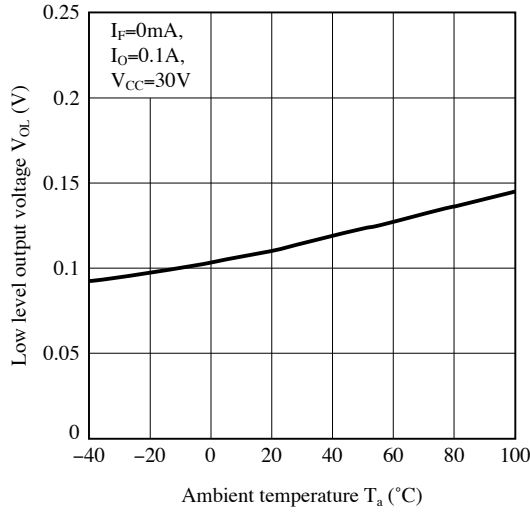
**Fig.14 High Level Output Voltage Drop vs. Ambient Temperature**



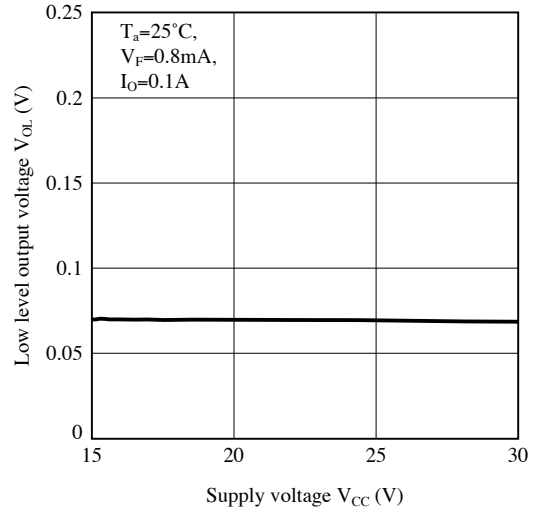
**Fig.15 High Level Output Voltage Drop vs. Supply Voltage**



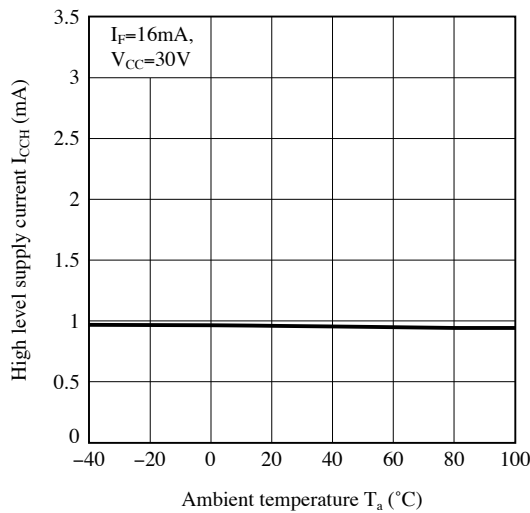
**Fig.16 Low Level Output Voltage vs. Ambient Temperature**



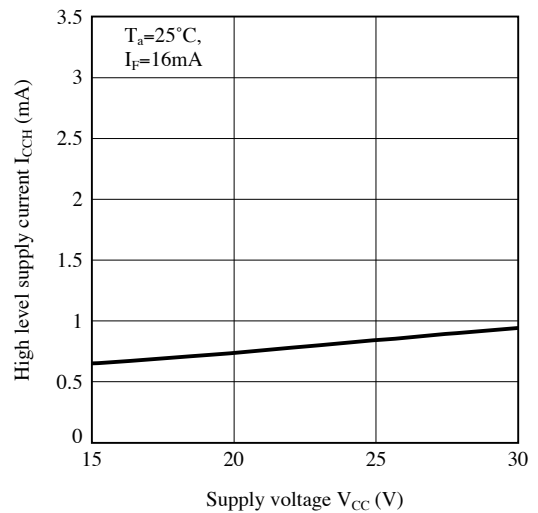
**Fig.17 Low Level Output Voltage vs. Supply Voltage**



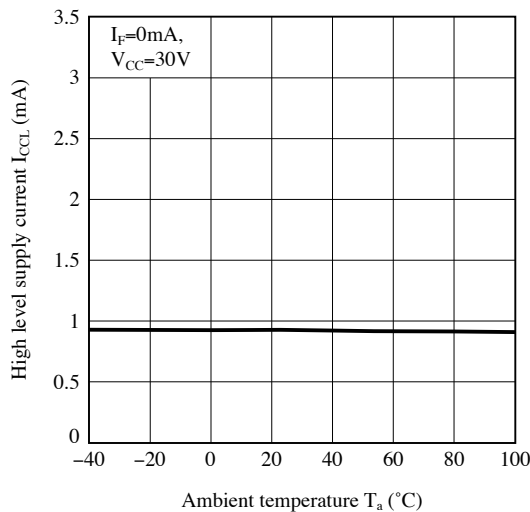
**Fig.18 High Level Supply Current vs. Ambient Temperature**



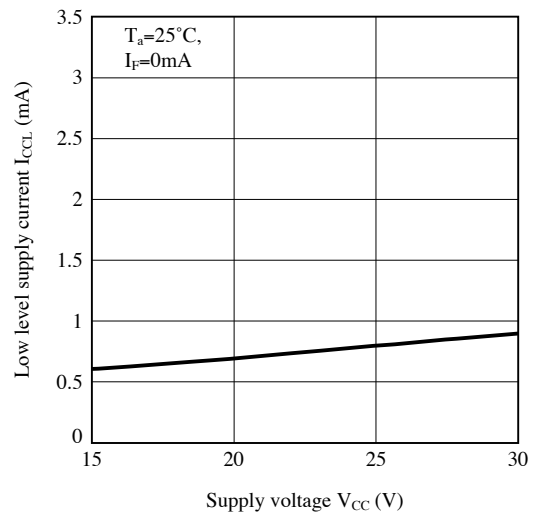
**Fig.19 High Level Supply Current vs. Supply Voltage**



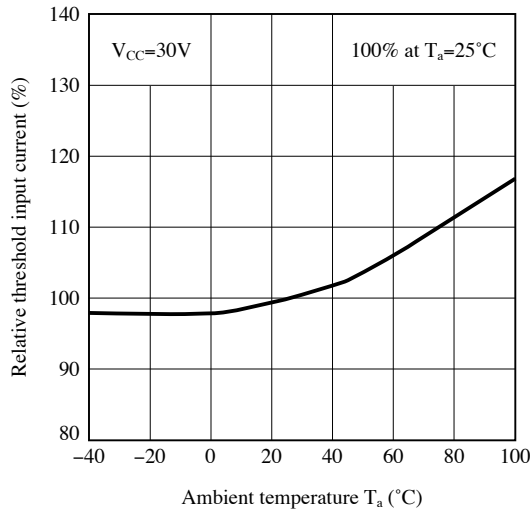
**Fig.20 Low Level Supply Current vs. Ambient Temperature**



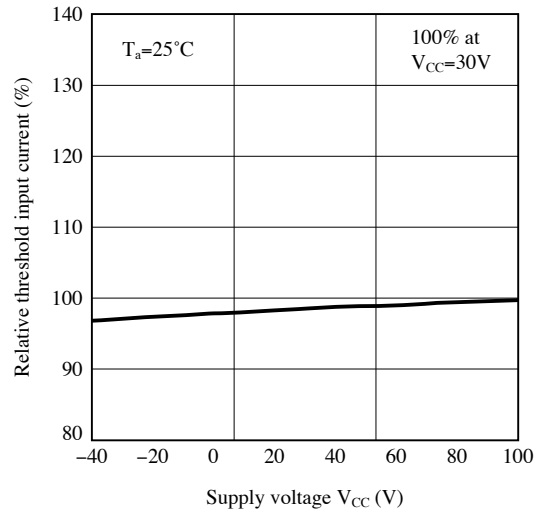
**Fig.21 Low Level Supply Current vs. Supply Voltage**



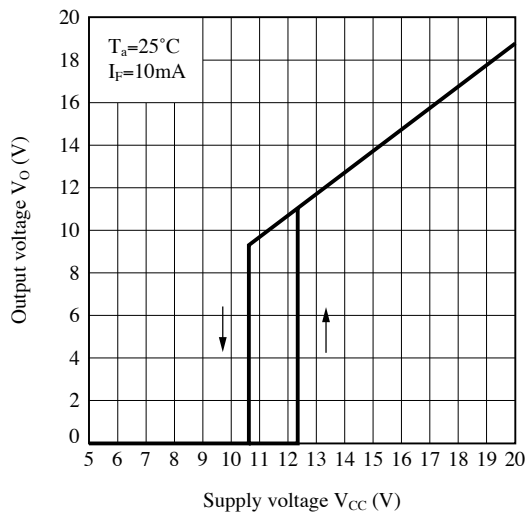
**Fig.22 "Low→High" Relative Threshold Input Current vs. Ambient Temperature**



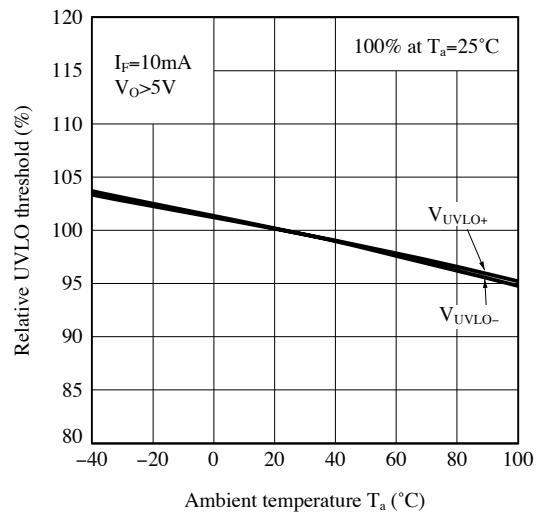
**Fig.23 "Low→High" Relative Threshold Input Current vs. Supply Voltage**



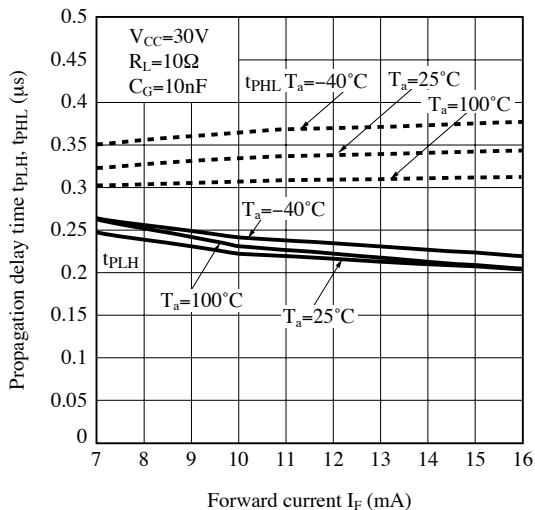
**Fig.24 Output Voltage vs. Supply Voltage (UVLO Threshold)**



**Fig.25 Relative UVLO Threshold vs. Ambient Temperature**



**Fig.26 Propagation Delay Time vs. Ambient Temperature**



Remarks : Please be aware that all data in the graph are just for reference and not for guarantee.

## ■ Design Considerations

### ● Recommended Operating Conditions

Parameter	Symbol	MIN.	MAX.	Unit
Input current (ON)	$I_F(\text{ON})$	7	16	mA
Input voltage (OFF)	$V_F(\text{OFF})$	-3	0.8	V
Supply voltage	$V_{CC}$	15	30	V
Operating temperature	$T_{opr}$	-40	100	°C

### ● Notes about static electricity

Transistor of detector side in bipolar configuration may be damaged by static electricity due to its minute design.

When handling these devices, general countermeasure against static electricity should be taken to avoid breakdown of devices or degradation of characteristics.

### ● Design guide

In order to stabilize power supply line, please certainly connect a by-pass capacitor of 0.1 $\mu$ F or more between  $V_{CC}$  and GND near the device.

In case that some sudden big noise caused by voltage variation is provided between primary and secondary terminals of photocoupler some current caused by it is floating capacitance may be generated and result in false operation since current may go through LED or current may change.

If the photocoupler may be used under the circumstances where noise will be generated we recommend to use the bypass capacitors at the both ends of LED.

The detector which is used in this device, has parasitic diode between each pins and GND.

There are cases that miss operation or destruction possibly may be occurred if electric potential of any pin becomes below GND level even for instant.

Therefore it shall be recommended to design the circuit that electric potential of any pin does not become below GND level.

This product is not designed against irradiation and incorporates non-coherent LED.

### ● Degradation

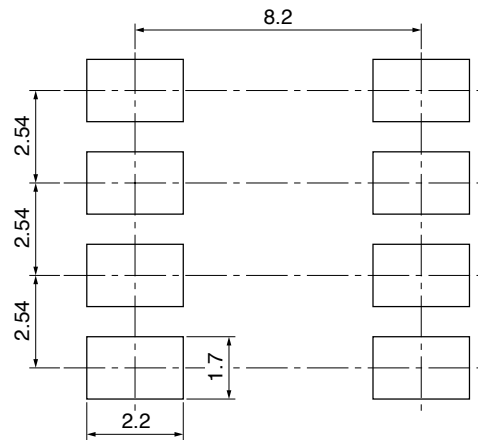
In general, the emission of the LED used in photocouplers will degrade over time.

In the case of long term operation, please take the general LED degradation (50% degradation over 5 years) into the design consideration.

Please decide the input current which become 2 times of MAX.  $I_{FLH}$ .

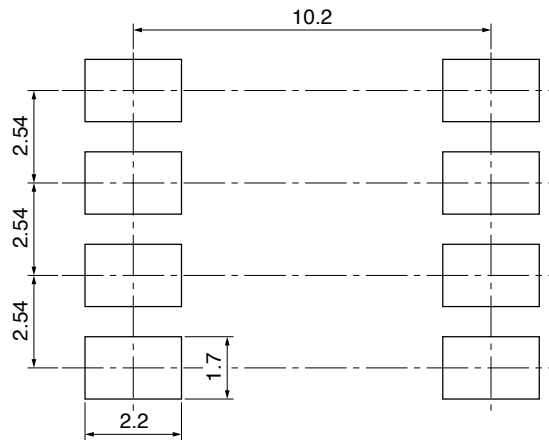
**● Recommended Foot Print (reference)**

SMT Gullwing Lead-form



(Unit : mm)

Wide SMT Gullwing Lead-form



(Unit : mm)

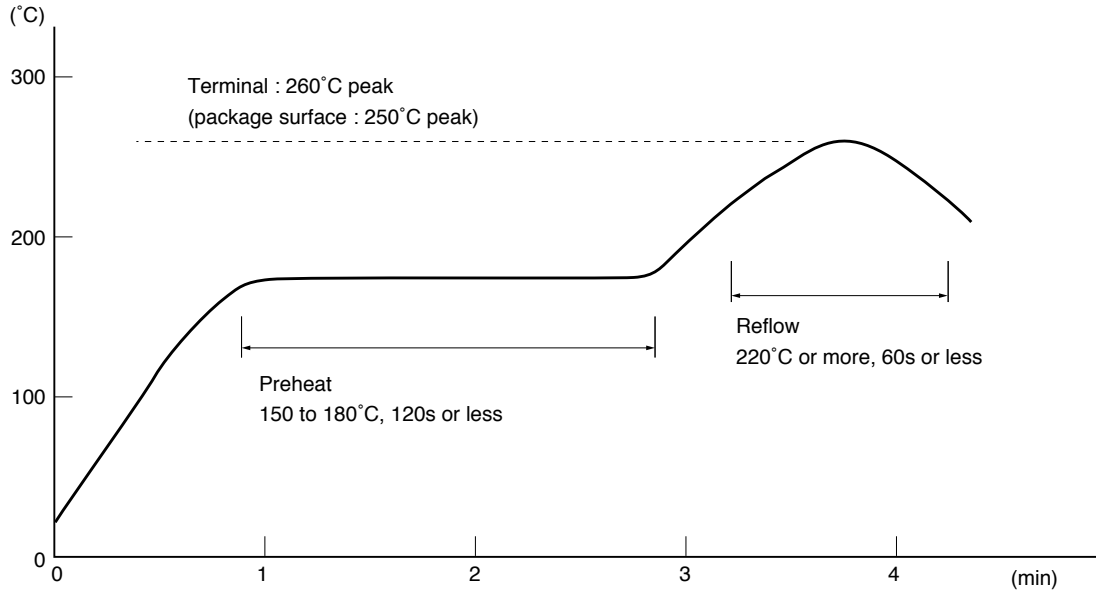
☆ For additional design assistance, please review our corresponding Optoelectronic Application Notes.

## ■ Manufacturing Guidelines

### ● Soldering Method

#### Reflow Soldering :

Reflow soldering should follow the temperature profile shown below.  
Soldering should not exceed the curve of temperature profile and time.  
Please don't solder more than twice.



#### Flow Soldering :

Due to SHARP's double transfer mold construction submersion in flow solder bath is allowed under the below listed guidelines.

Flow soldering should be completed below 270°C and within 10s.  
Preheating is within the bounds of 100 to 150°C and 30 to 80s.  
Please don't solder more than twice.

#### Hand soldering

Hand soldering should be completed within 3 s when the point of solder iron is below 400°C.  
Please don't solder more than twice.

#### Other notice

Please test the soldering method in actual condition and make sure the soldering works fine, since the impact on the junction between the device and PCB varies depending on the tooling and soldering conditions.

**● Cleaning instructions****Solvent cleaning :**

Solvent temperature should be 45°C or below. Immersion time should be 3minutes or less.

**Ultrasonic cleaning :**

The impact on the device varies depending on the size of the cleaning bath, ultrasonic output, cleaning time, size of PCB and mounting method of the device.

Therefore, please make sure the device withstands the ultrasonic cleaning in actual conditions in advance of mass production.

**Recommended solvent materials :**

Ethyl alcohol, Methyl alcohol and Isopropyl alcohol

In case the other type of solvent materials are intended to be used, please make sure they work fine in actual using conditions since some materials may erode the packaging resin.

**● Presence of ODC**

This product shall not contain the following materials.

And they are not used in the production process for this product.

Regulation substances : CFCs, Halon, Carbon tetrachloride, 1.1.1-Trichloroethane (Methylchloroform)

Specific brominated flame retardants such as the PBB and PBDE are not used in this product at all.

This product shall not contain the following materials banned in the RoHS Directive (2002/95/EC).

•Lead, Mercury, Cadmium, Hexavalent chromium, Polybrominated biphenyls (PBB), Polybrominated diphenyl ethers (PBDE).



**■ Package specification****● Sleeve package**

## Package materials

Sleeve : HIPS (with anti-static material)

Stopper : Styrene-Elastomer

## Package method

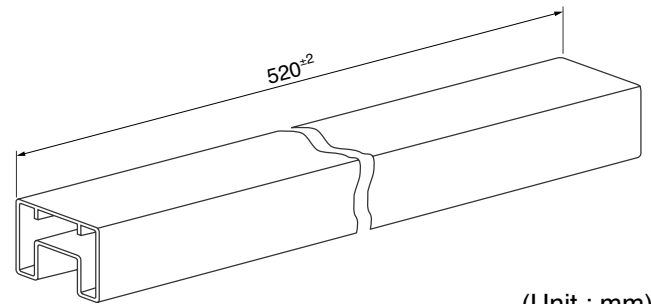
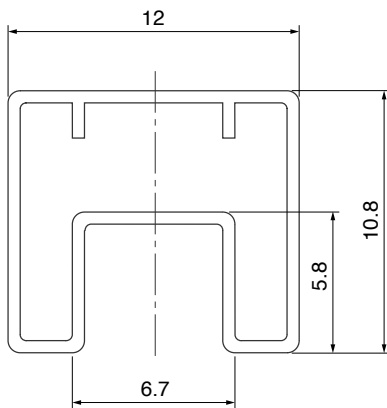
MAX. 50pcs of products shall be packaged in a sleeve.

Both ends shall be closed by tabbed and tabless stoppers.

The product shall be arranged in the sleeve with its anode mark on the tabless stopper side.

MAX. 20 sleeves in one case.

## Sleeve outline dimensions



(Unit : mm)

● **Tape and Reel package**

**1. SMT Gullwing Lead-Form**

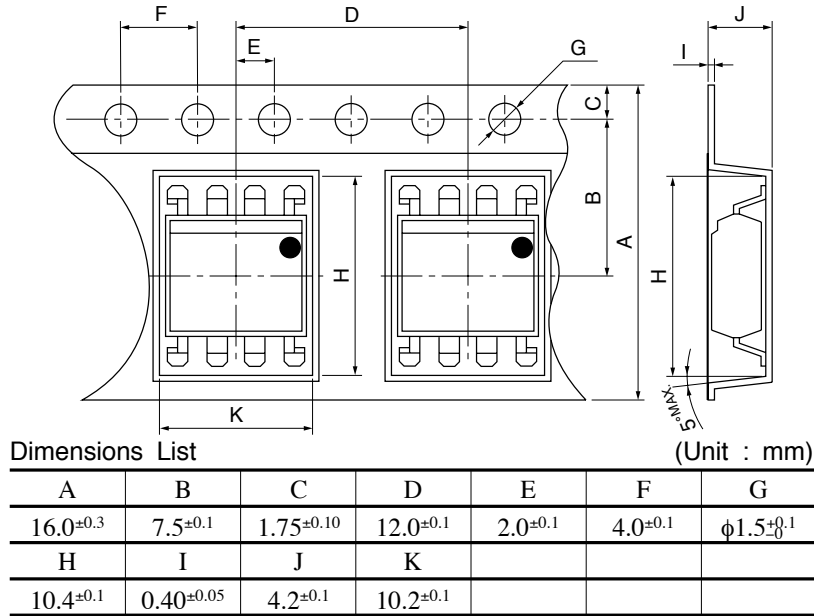
Package materials

Carrier tape : A-PET (with anti-static material)

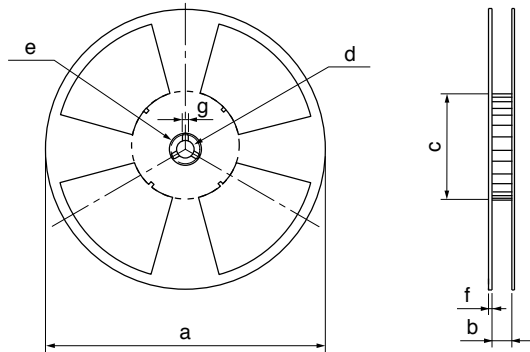
Cover tape : PET (three layer system)

Reel : PS

Carrier tape structure and Dimensions



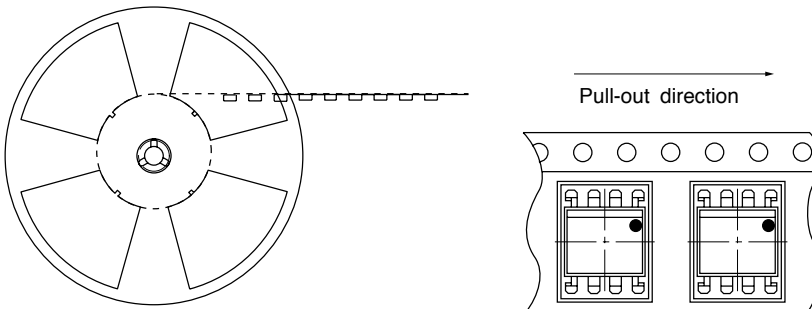
Reel structure and Dimensions



**Dimensions List** (Unit : mm)

a	b	c	d
φ330	17.5±1.5	φ100±1	φ13.0±0.5
e	f	g	
φ23±1	2.0±0.5	2.0±0.5	

Direction of product insertion



[Packing : 1 000pcs/reel]

● Tape and Reel package

2. Wide SMT Gullwing Lead-Form

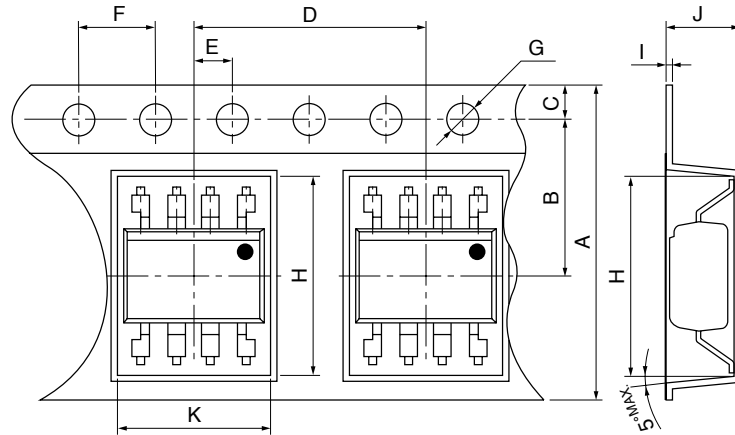
Package materials

Carrier tape : A-PET (with anti-static material)

Cover tape : PET (three layer system)

Reel : PS

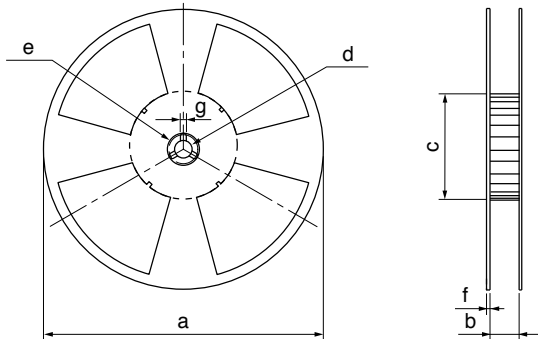
Carrier tape structure and Dimensions



Dimensions List (Unit : mm)

A	B	C	D	E	F	G
24.0±0.3	11.5±0.1	1.75±0.10	12.0±0.1	2.0±0.1	4.0±0.1	φ1.5±0.1
H	I	J	K			
12.4±0.1	0.40±0.05	4.05±0.10	10.0±0.1			

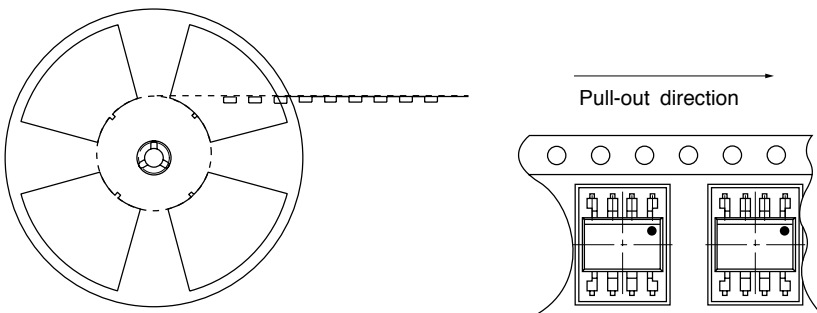
Reel structure and Dimensions



Dimensions List (Unit : mm)

a	b	c	d
φ330	25.5±1.5	φ100±1	φ13.0±0.5
e	f	g	
φ23±1	2.0±0.5	2.0±0.5	

Direction of product insertion



[Packing : 1 000pcs/reel]

**■ Important Notices**

· The circuit application examples in this publication are provided to explain representative applications of SHARP devices and are not intended to guarantee any circuit design or license any intellectual property rights. SHARP takes no responsibility for any problems related to any intellectual property right of a third party resulting from the use of SHARP's devices.

· Contact SHARP in order to obtain the latest device specification sheets before using any SHARP device. SHARP reserves the right to make changes in the specifications, characteristics, data, materials, structure, and other contents described herein at any time without notice in order to improve design or reliability. Manufacturing locations are also subject to change without notice.

· Observe the following points when using any devices in this publication. SHARP takes no responsibility for damage caused by improper use of the devices which does not meet the conditions and absolute maximum ratings to be used specified in the relevant specification sheet nor meet the following conditions:

(i) The devices in this publication are designed for use in general electronic equipment designs such as:

- Personal computers
- Office automation equipment
- Telecommunication equipment [terminal]
- Test and measurement equipment
- Industrial control
- Audio visual equipment
- Consumer electronics

(ii) Measures such as fail-safe function and redundant design should be taken to ensure reliability and safety when SHARP devices are used for or in connection

with equipment that requires higher reliability such as:

- Transportation control and safety equipment (i.e., aircraft, trains, automobiles, etc.)
- Traffic signals
- Gas leakage sensor breakers
- Alarm equipment
- Various safety devices, etc.

(iii) SHARP devices shall not be used for or in connection with equipment that requires an extremely high level of reliability and safety such as:

- Space applications
- Telecommunication equipment [trunk lines]
- Nuclear power control equipment
- Medical and other life support equipment (e.g., scuba).

· If the SHARP devices listed in this publication fall within the scope of strategic products described in the Foreign Exchange and Foreign Trade Law of Japan, it is necessary to obtain approval to export such SHARP devices.

· This publication is the proprietary product of SHARP and is copyrighted, with all rights reserved. Under the copyright laws, no part of this publication may be reproduced or transmitted in any form or by any means, electronic or mechanical, for any purpose, in whole or in part, without the express written permission of SHARP. Express written permission is also required before any use of this publication may be made by a third party.

· Contact and consult with a SHARP representative if there are any questions about the contents of this publication.