



**PB137**

## POSITIVE VOLTAGE REGULATOR FOR BATTERY CHARGER

- REVERSE LEAKAGE CURRENT LESS THAN 10  $\mu$ A
- THREE TERMINAL FIXED VERSION (13.7V) OUTPUT CURRENT IN EXCESS OF 1.5A
- AVAILABLE IN  $\pm 1\%$  (AC) SELECTION AT 25°C
- TYPICAL DROPOUT VOLTAGE 2V
- TEMPERATURE RANGE 0°C TO 150°C

### DESCRIPTION

The PB137 is a positive voltage regulator able to provide 1.5A, at  $V_{OUT}=13.7V$  and is intended as a charger for lead acid battery. The main feature is a reverse leakage current (Max 10 $\mu$ A at  $T_J = 0$  to 40°C  $V_{IN}$  = floating and  $V_{OUT} = 13.7V$ ). It is available in TO-220 and it employs internal current limiting, thermal shut-down and safe area protection, making it essentially indestructible. If adequate heat-sinking is provided, they can deliver over 1A output current.

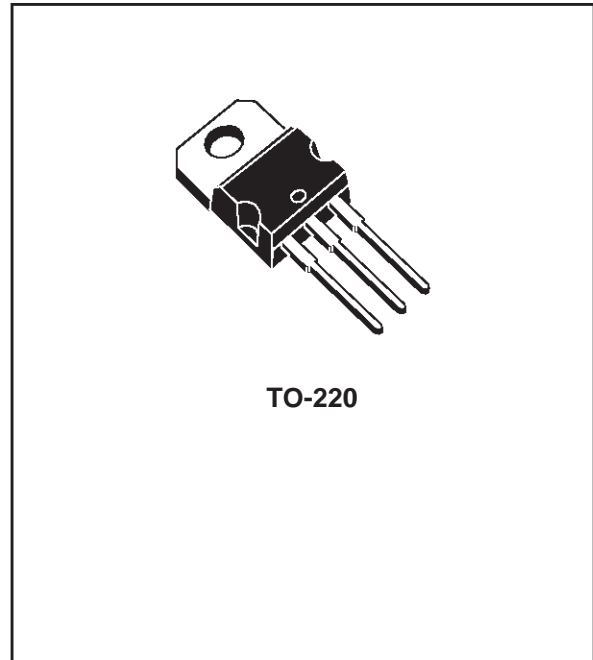

### SCHEMATIC DIAGRAM

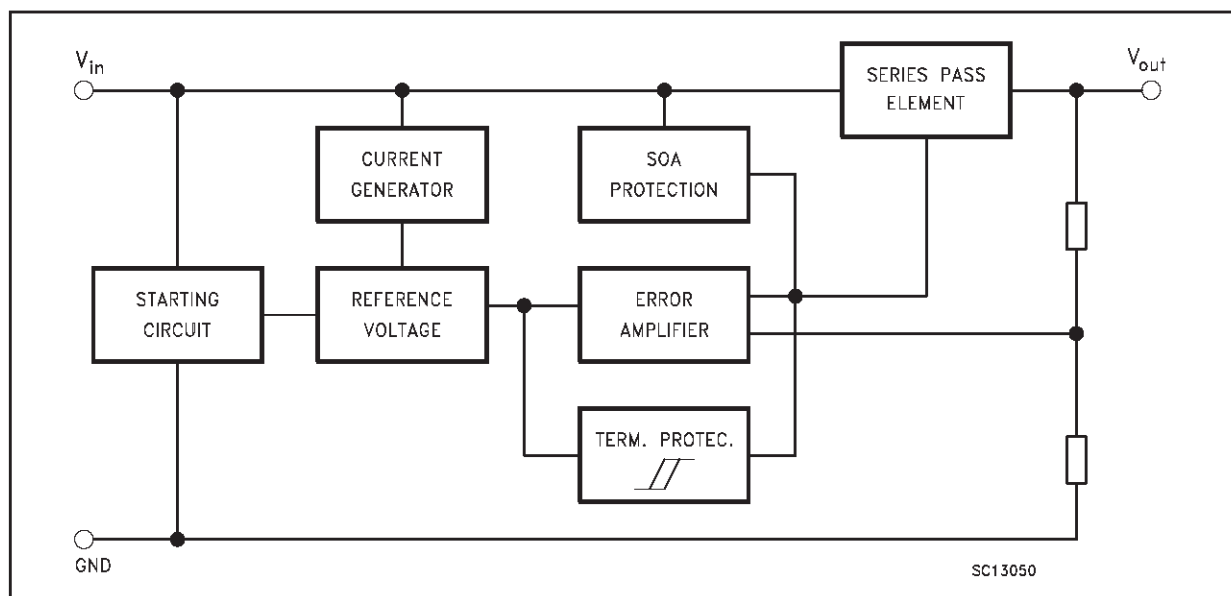

**ABSOLUTE MAXIMUM RATINGS**

Symbol	Parameter	Value	Unit
$V_i$	DC Input Voltage	40	V
$I_o$	Output Current	Internally limited	mA
$P_{tot}$	Power Dissipation	Internally limited	mW
$T_{stg}$	Storage Temperature Range	- 65 to 150	°C
$T_{op}$	Operating Junction Temperature Range	0 to 150	°C

Absolute Maximum Rating are those values beyond wich damage to the device may occur. Functional operation under these conditions is not implied.

**THERMAL DATA**

Symbol	Parameter	Value	Unit
$R_{thj-case}$	Thermal Resistance Junction-case	3	°C/W
$R_{thj-amb}$	Thermal Resistance Junction-ambient	50	°C/W

**CONNECTION DIAGRAM (top view)**

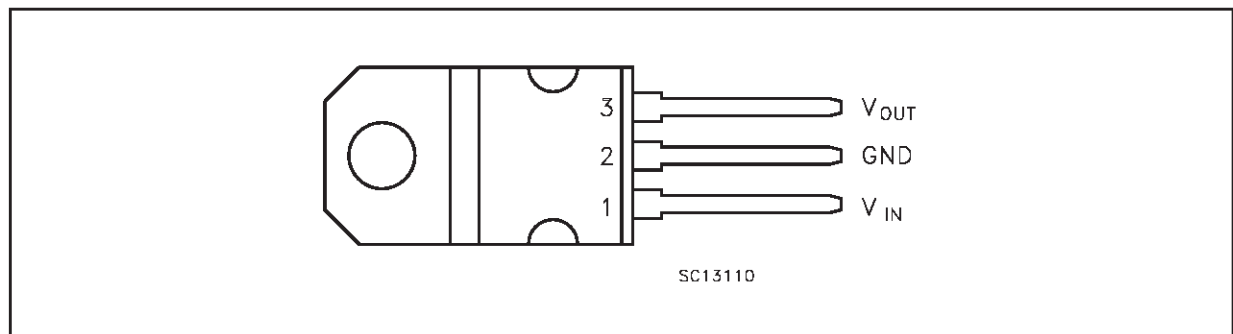

**ORDERING NUMBERS**

Type	Output Voltage
PB137ACV	13.7 V

**APPLICATION CIRCUIT**

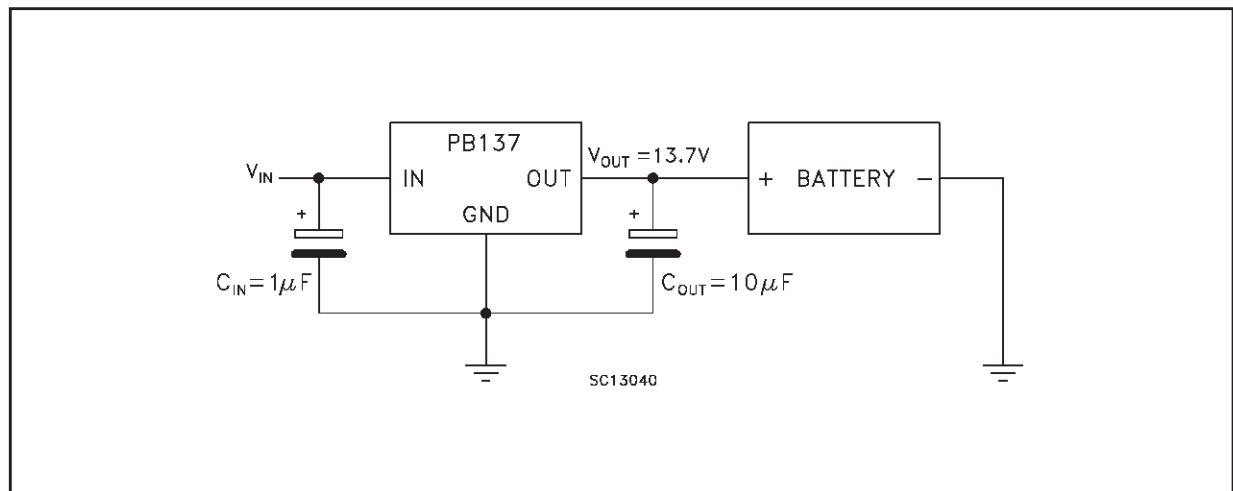

**ELECTRICAL CHARACTERISTICS FOR PB137** (refer to the test circuits,  $V_I = 18\text{ V}$ ,  $I_{OUT} = 500\text{ mA}$ ,  $T_j = 0\text{ to }150\text{ }^\circ\text{C}$ ,  $C_{OUT} = 10\text{ }\mu\text{F}$  unless otherwise specified)

Symbol	Parameter	Test Conditions	Min.	Typ.	Max.	Unit
$V_o$	Output Voltage	$T_j = 25\text{ }^\circ\text{C}$	13.56	13.7	13.84	V
			13.43	13.7	13.97	V
$\Delta V_o$	Line Regulation	$V_i = 16\text{ to }28.7\text{ V}$ , $T_j = 25\text{ }^\circ\text{C}$		60	150	mV
$\Delta V_o$	Load Regulation	$I_o = 5\text{ to }1500\text{ mA}$ , $T_j = 25\text{ }^\circ\text{C}$		65	100	mV
$I_d$	Quiescent Current	$T_j = 25\text{ }^\circ\text{C}$		4	8	mA
$\Delta I_d$	Delta Quiescent Current vs Line	$V_i = 16\text{ to }28.7\text{ V}$			4	mA
$\Delta I_d$	Delta Quiescent Current vs Load	$I_o = 5\text{ to }1000\text{ mA}$			1.2	mA
$V_d$	Dropout Voltage	$I_o = 1\text{ A}$ , $T_j = 25\text{ }^\circ\text{C}$		2.1	2.6	V
$I_{SC}$	Short Circuit Current	$V_i - V_o = 5\text{ V}$ , $T_j = 25\text{ }^\circ\text{C}$		2.2		A
eN	Output Noise Voltage	$B = 10\text{ Hz to }10\text{ KHz}$ , $T_j = 25\text{ }^\circ\text{C}$		300		$\mu\text{Vrms}$
SVR	Supply Voltage Rejection	$f = 120\text{ Hz}$ , $T_j = 25\text{ }^\circ\text{C}$		58		dB
$I_{REV}$	Reverse Leakage Current	$V_{OUT} = 13.7\text{ V}$ , $V_{IN} = \text{floating}$ , $T_j = 0\text{ to }40\text{ }^\circ\text{C}$		0.1	10	$\mu\text{A}$
S	Long Term Stability	$T_j = 125\text{ }^\circ\text{C}$ , 1000hrs			0.5	%

TYPICAL PERFORMANCE CHARACTERISTICS ( $T_J=25^{\circ}\text{C}$ )

Output Voltage vs Temperature

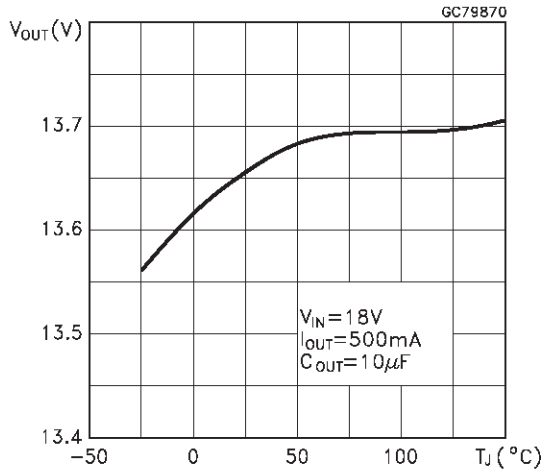

Output Voltage vs Input Voltage

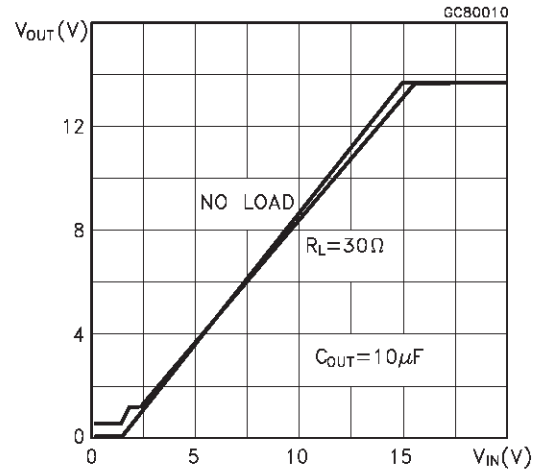

Output Voltage vs Output Current

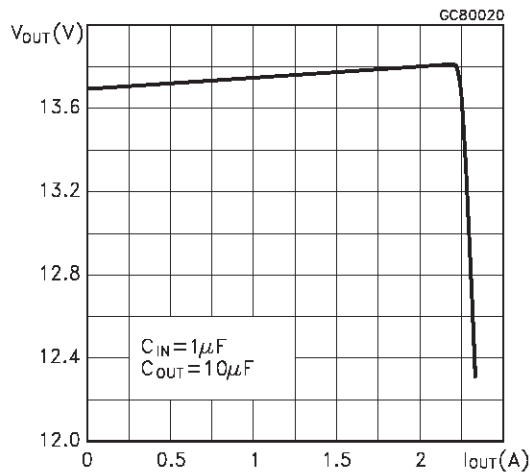

Load Regulation vs Temperature

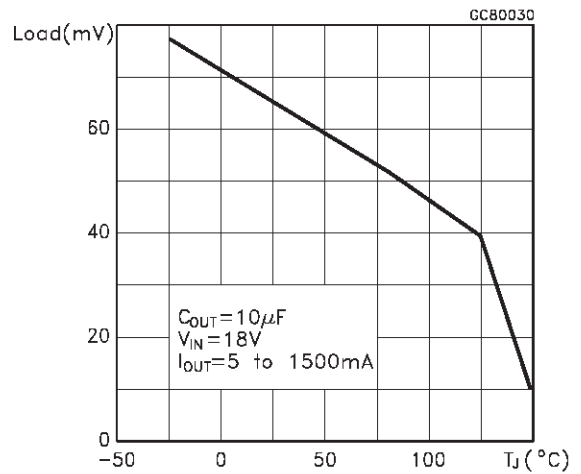

Line Regulation vs Temperature

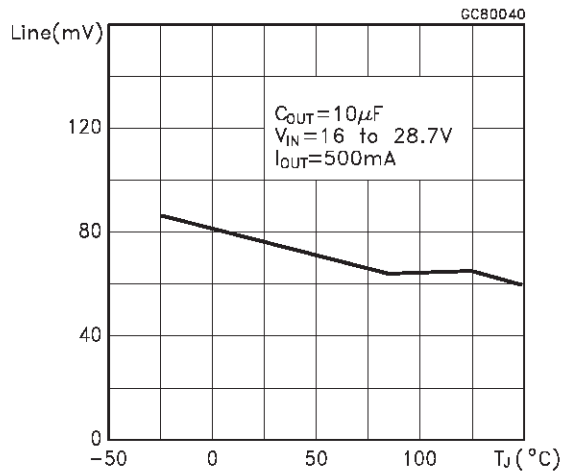

Dropout Voltage vs Temperature

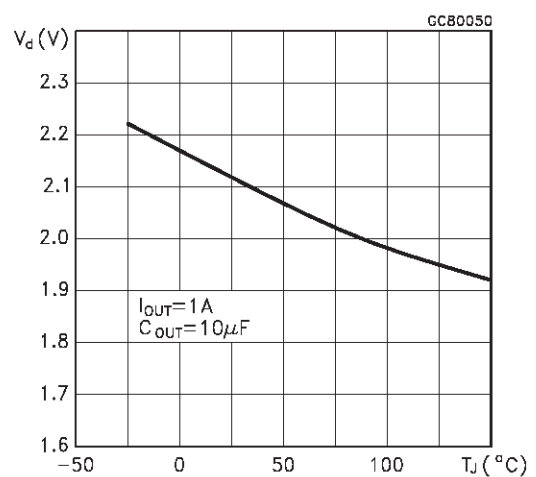

**TYPICAL PERFORMANCE CHARACTERISTICS** (continued)

Dropout Voltage vs Output Current

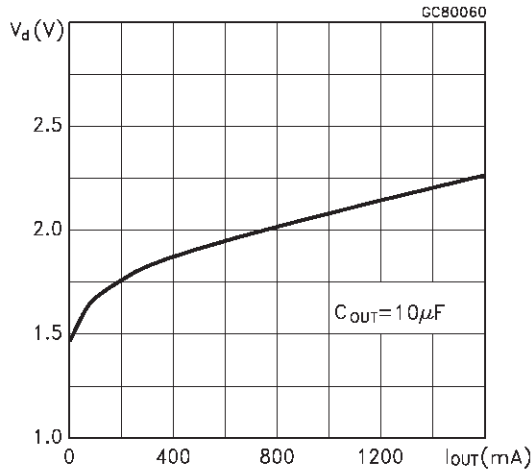

Short Circuit Current vs Dropout Voltage

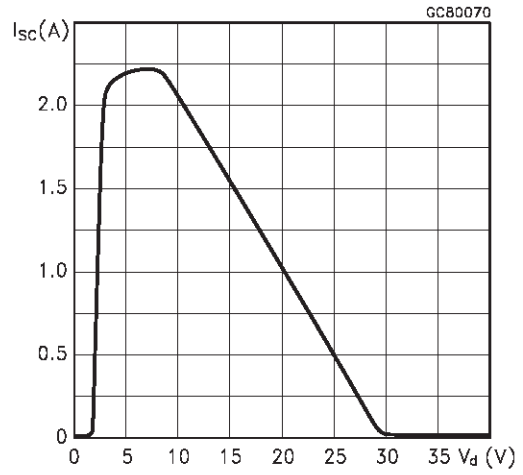

Short Circuit Current vs Temperature

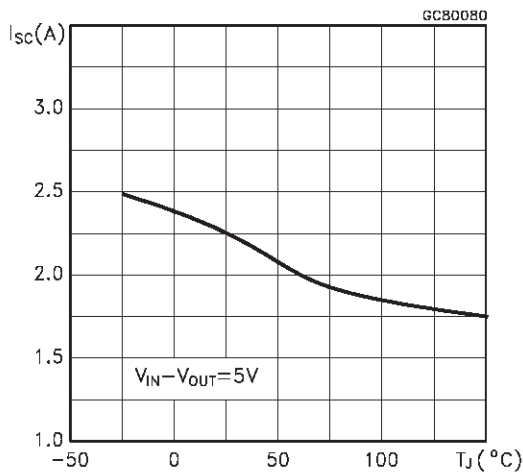

Reverse Leakage Current vs Temperature

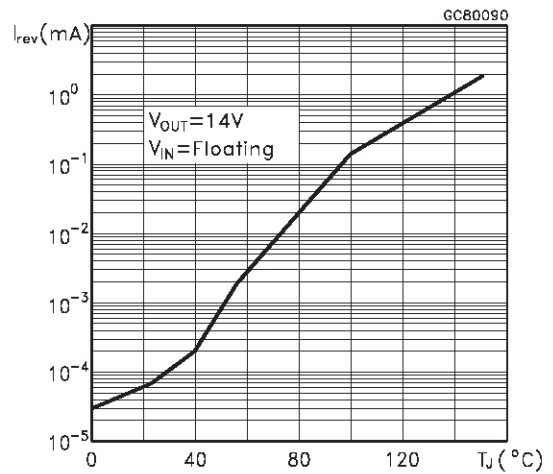

Quiescent Current vs Temperature

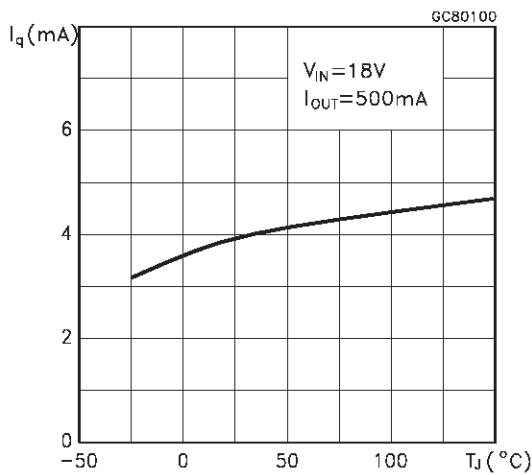

Quiescent Current vs Output Current

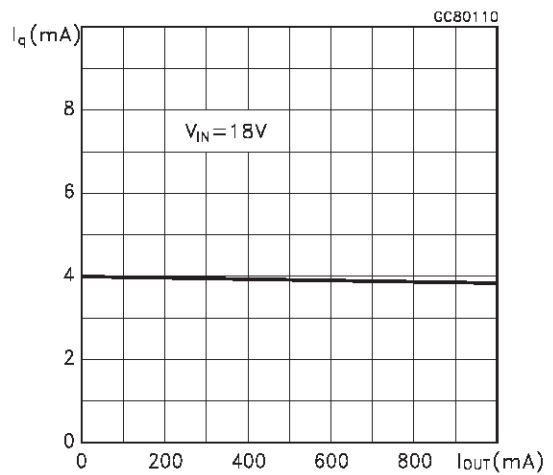

TYPICAL PERFORMANCE CHARACTERISTICS (continued)

Quiescent Current vs Input Voltage

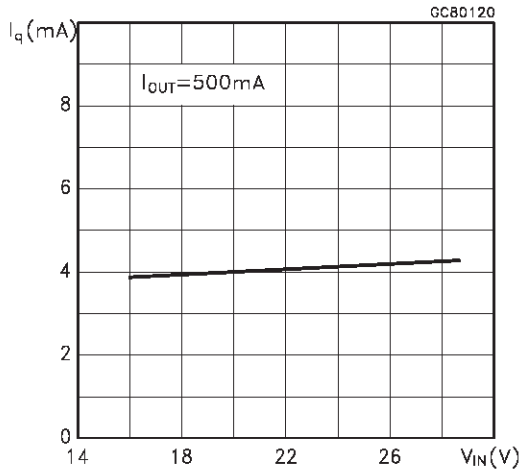

Thermal Protection

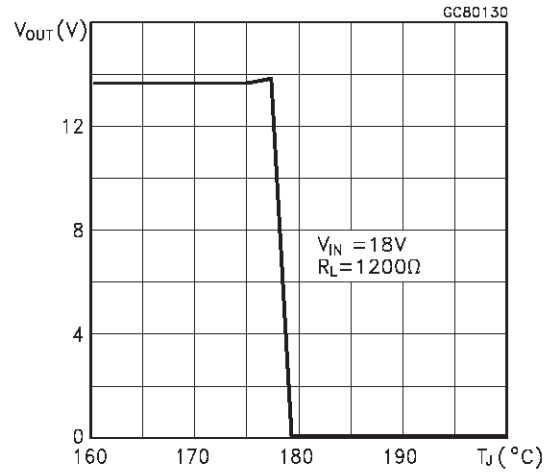

Supply Voltage Rejection vs Output Current

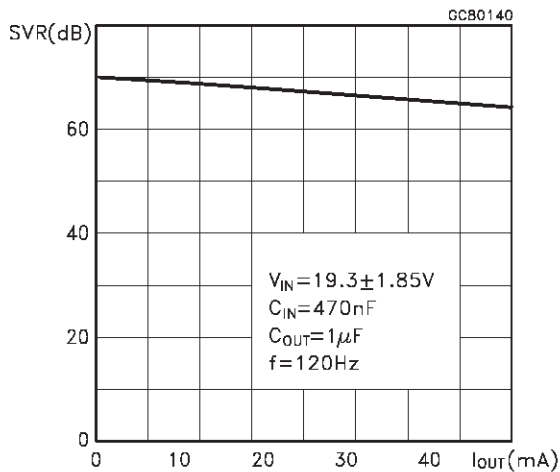

Supply Voltage Rejection vs Temperature

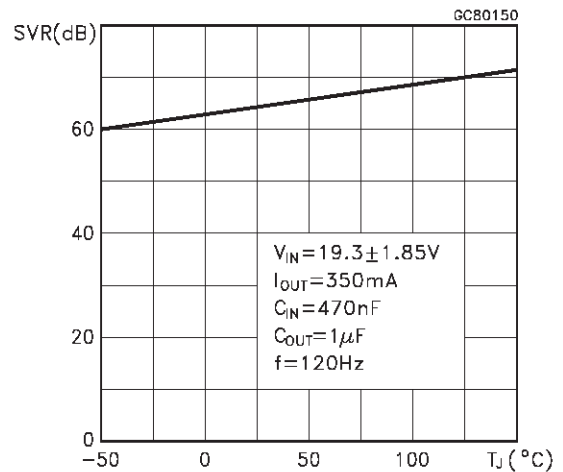

Line Transient Response

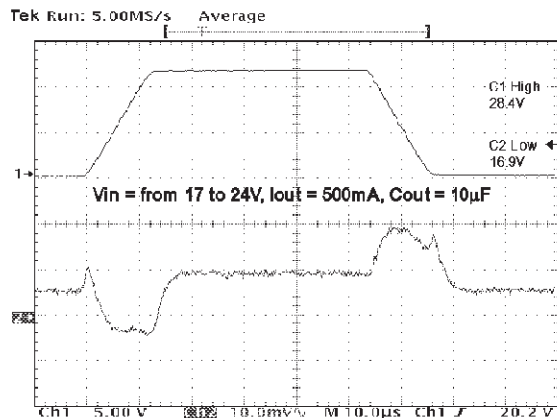

$V_{IN} = 17 \text{ to } 28.4\text{V}, I_{OUT} = 0.5\text{A}, C_{OUT} = 10\mu\text{F}$

Load Transient Response

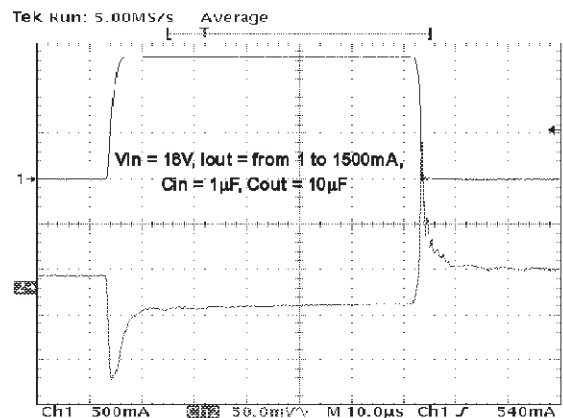

$V_{IN} = 18\text{V}, I_{OUT} = 5 \text{ to } 1.5\text{A}, C_{IN} = 1\mu\text{F}, C_{OUT} = 10\mu\text{F}$

## TO-220 MECHANICAL DATA

DIM.	mm			inch		
	MIN.	TYP.	MAX.	MIN.	TYP.	MAX.
A	4.40		4.60	0.173		0.181
C	1.23		1.32	0.048		0.051
D	2.40		2.72	0.094		0.107
D1		1.27			0.050	
E	0.49		0.70	0.019		0.027
F	0.61		0.88	0.024		0.034
F1	1.14		1.70	0.044		0.067
F2	1.14		1.70	0.044		0.067
G	4.95		5.15	0.194		0.203
G1	2.4		2.7	0.094		0.106
H2	10.0		10.40	0.393		0.409
L2		16.4			0.645	
L4	13.0		14.0	0.511		0.551
L5	2.65		2.95	0.104		0.116
L6	15.25		15.75	0.600		0.620
L7	6.2		6.6	0.244		0.260
L9	3.5		3.93	0.137		0.154
DIA.	3.75		3.85	0.147		0.151

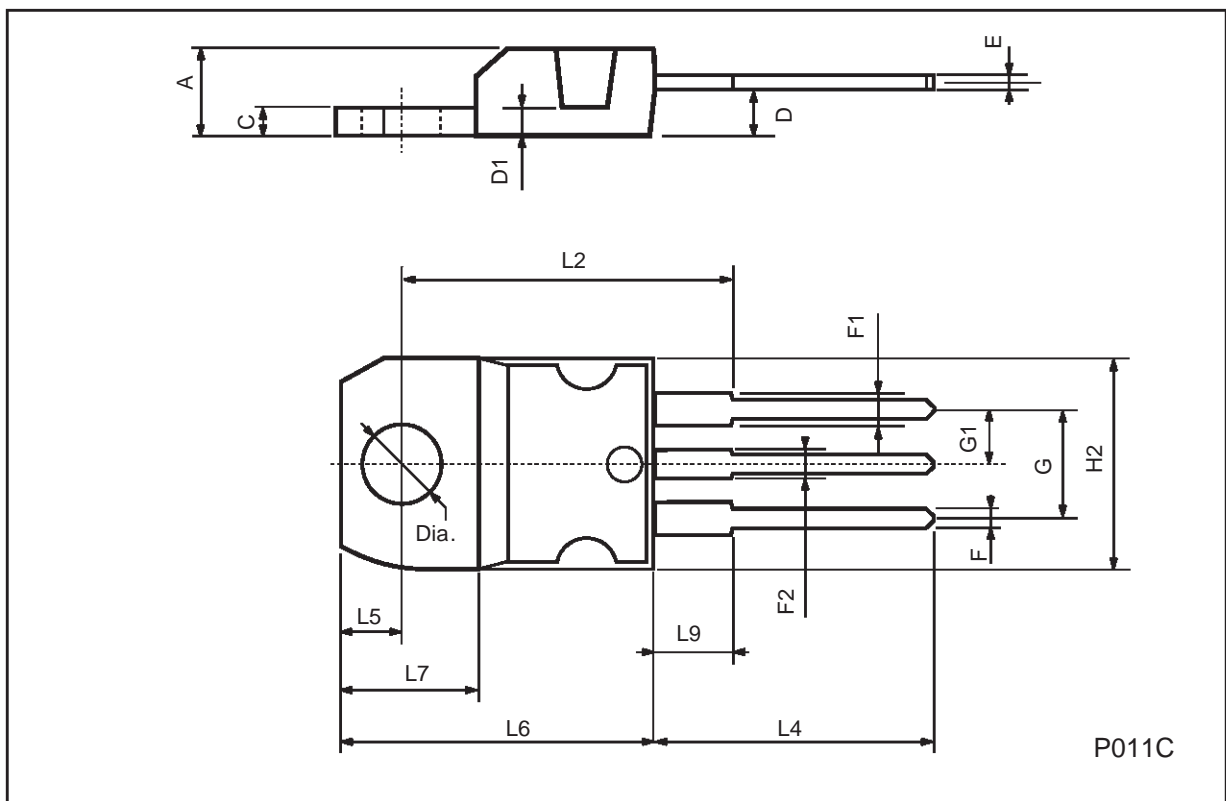

Information furnished is believed to be accurate and reliable. However, STMicroelectronics assumes no responsibility for the consequences of use of such information nor for any infringement of patents or other rights of third parties which may result from its use. No license is granted by implication or otherwise under any patent or patent rights of STMicroelectronics. Specification mentioned in this publication are subject to change without notice. This publication supersedes and replaces all information previously supplied. STMicroelectronics products are not authorized for use as critical components in life support devices or systems without express written approval of STMicroelectronics.

The ST logo is a registered trademark of STMicroelectronics

© 1998 STMicroelectronics – Printed in Italy – All Rights Reserved  
STMicroelectronics GROUP OF COMPANIES

Australia - Brazil - Canada - China - France - Germany - Italy - Japan - Korea - Malaysia - Malta - Mexico - Morocco - The Netherlands -  
Singapore - Spain - Sweden - Switzerland - Taiwan - Thailand - United Kingdom - U.S.A.

<http://www.st.com>