



OPA137
OPA2137
OPA4137

LOW COST FET-INPUT OPERATIONAL AMPLIFIERS

MicroAmplifier™ Series

FEATURES

- **FET INPUT:** $I_B = 5\text{pA}$
- **LOW OFFSET VOLTAGE:** 1.5mV
- **WIDE SUPPLY RANGE:** $\pm 2.25\text{V}$ to $\pm 18\text{V}$
- **LOW QUIESCENT CURRENT:** 220 μA /channel
- **EXCELLENT SPEED/POWER:** 1MHz
- **INPUT TO POSITIVE SUPPLY**
- **MicroSIZE PACKAGES:** SOT-23-5, MSOP-8
- **SINGLE, DUAL, AND QUAD**

APPLICATIONS

- **STRAIN GAGE AMPLIFIER**
- **PHOTODETECTOR AMPLIFIER**
- **PRECISION INTEGRATOR**
- **BATTERY-POWERED INSTRUMENTS**
- **TEST EQUIPMENT**
- **ACTIVE FILTERS**

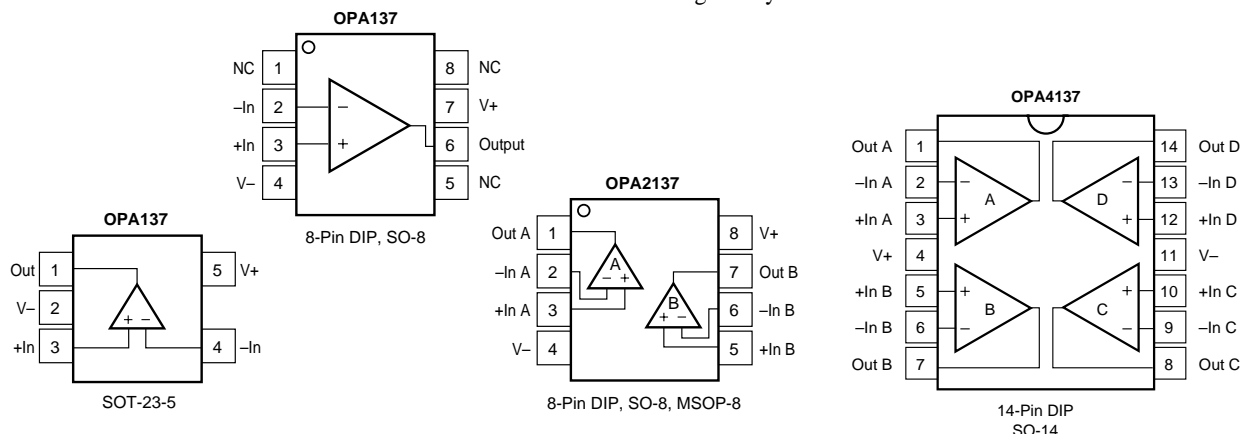
DESCRIPTION

OPA137 series FET-input operational amplifiers are designed for low cost and miniature applications. In addition to small size (SOT-23-5 and MSOP-8 packages), they provide low input bias current (5pA), low quiescent current (220 μA /channel), and high open-loop gain (94dB).

Either single (+4.5V to +36V) or dual (± 2.25 to $\pm 18\text{V}$) supplies can be used. The input common-mode voltage range includes the positive supply—suitable for many single-supply applications. Single, dual, and quad versions have identical specifications for maximum design flexibility.

OPA137 op amps are easy to use and free from phase inversion and overload problems found in some FET-input amplifiers. High performance, including linearity, is maintained as the amplifiers swing to their specified limits. In addition, the combination of high slew rate (3.5V/ μs) and wide bandwidth (1MHz) provide fast settling time assuring good dynamic response. Dual and quad designs feature completely independent circuitry for lowest crosstalk and freedom from interaction.

The single (OPA137) packages are the tiny 5-lead SOT-23-5 surface mount, SO-8 surface mount, and 8-pin DIP. The dual (OPA2137) comes in the miniature MSOP-8 surface mount, SO-8 surface mount, and 8-pin DIP packages. The quad (OPA4137) packages are the SO-14 surface mount and the 14-pin DIP. All are specified from -40°C to $+85^\circ\text{C}$ and operate from -55°C to $+125^\circ\text{C}$. A SPICE macromodel is available for design analysis.



International Airport Industrial Park • Mailing Address: PO Box 11400, Tucson, AZ 85734 • Street Address: 6730 S. Tucson Blvd., Tucson, AZ 85706 • Tel: (520) 746-1111 • Twx: 910-952-1111
Internet: <http://www.burr-brown.com/> • FAXLine: (800) 548-6133 (US/Canada Only) • Cable: BBRCORP • Telex: 066-6491 • FAX: (520) 889-1510 • Immediate Product Info: (800) 548-6132

SPECIFICATIONS: $V_S = \pm 15V$

At $T_A = +25^\circ C$, $R_L = 10k\Omega$ connected to ground, unless otherwise noted.

Boldface limits apply over the specified temperature range, $T_A = -40^\circ C$ to $+85^\circ C$.

| PARAMETER | CONDITION | OPA137N, U, P OPA2137E, U, P OPA4137U, P | | | OPA137NA, UA, PA OPA2137EA, UA, PA OPA4137UA, PA | | | UNITS |
|---|--|--|---|--|--|---------------------------------------|---|--|
| | | MIN | TYP | MAX | MIN | TYP | MAX | |
| OFFSET VOLTAGE Input Offset Voltage V_{OS} $T_A = -40^\circ C$ to $+85^\circ C$ vs Temperature dV_{OS}/dT vs Power Supply PSRR $T_A = -40^\circ C$ to $+85^\circ C$ Channel Separation (dual, quad) | $T_A = -40^\circ C$ to $+85^\circ C$ $V_S = \pm 3V$ to $\pm 18V$ dc | | ± 1.5 ± 2.5 ± 15 ± 90 0.6 | ± 3 ± 7 ± 250 ± 250 | | ± 2.5 ± 3.5 * * * | ± 10 ± 15 * * * | mV mV $\mu V/^\circ C$ $\mu V/V$ $\mu V/V$ |
| INPUT BIAS CURRENT Input Bias Current I_B vs Temperature Input Offset Current I_{OS} | $V_{CM} = 0V$ | | See Typical Curve ± 5 ± 2 | ± 100 ± 50 | | * * * | * * * | pA pA |
| NOISE Input Voltage Noise, $f = 0.1$ to $10Hz$ Input Voltage Noise Density, $f = 1kHz$ e_n Current Noise Density, $f = 1kHz$ i_n | | | 2 45 1.2 | | | * * * | | $\mu Vp-p$ nV/\sqrt{Hz} fA/\sqrt{Hz} |
| INPUT VOLTAGE RANGE Common-Mode Voltage Range V_{CM} Common-Mode Rejection Ratio CMRR OPA137, OPA2137 OPA4137 $T_A = -40^\circ C$ to $+85^\circ C$ OPA137, OPA2137 OPA4137 | $V_{CM} = -12V$ to $15V$ $V_{CM} = -12V$ to $15V$ | $(V-) + 3$ 76 74 72 70 | 84 84 | $(V+)$ | * 70 70 70 70 | * * * * | * | V dB dB dB |
| INPUT IMPEDANCE Differential Common-Mode | | | $10^{10} \parallel 1$ $10^{12} \parallel 2$ | | | * * | | $\Omega \parallel pF$ $\Omega \parallel pF$ |
| OPEN-LOOP GAIN Open-Loop Voltage Gain A_{OL} $T_A = -40^\circ C$ to $+85^\circ C$ | $V_O = -13.8V$ to $13.9V$ $V_O = -13.8V$ to $13.9V$ | 86 86 | 94 | | * * | * * | | dB dB |
| FREQUENCY RESPONSE Gain-Bandwidth Product GBW Slew Rate SR Settling Time, 0.1% 0.01% Overload Recovery Time Total Harmonic Distortion + Noise THD+N | $G = 1$ $G = 1, 10V$ Step, $C_L = 100pF$ $G = 1, 10V$ Step, $C_L = 100pF$ $V_{IN} * G = V_S$ $G = 1, f = 1kHz, 3.5V_{rms}$ | | 1 3.5 8 10 1 0.05 | | | * * * * * * | | MHz $V/\mu s$ μs μs μs % |
| OUTPUT Voltage Output V_{OUT} $T_A = -40^\circ C$ to $+85^\circ C$ Short-Circuit Current I_{SC} Capacitive Load Drive C_{LOAD} | | $(V-) + 1.2$ $(V-) + 1.2$ | $(V+) - 1.1$ $(V+) - 1.1$ -25/+60 1000 | | * * * * | * * * * | | V V mA pF |
| POWER SUPPLY Specified Operating Range V_S Operating Voltage Range Dual Supplies Single Supply Quiescent Current I_Q $T_A = -40^\circ C$ to $+85^\circ C$ | $I_O = 0$ $I_O = 0$ | $\pm 2.25^{(1)}$ +4.5 | ± 15 ± 220 | ± 18 +36 ± 270 ± 375 | * * * * | * * * * | | V V V μA μA |
| TEMPERATURE RANGE Specified Range Operating Range Storage Range Thermal Resistance θ_{JA} SOT-23-5 Surface Mount MSOP-8 Surface Mount SO-8 Surface Mount 8-Pin DIP SO-14 Surface Mount 14-Pin DIP | | -40 -55 -55 | | +85 +125 +125 | * * * | * * * | | $^\circ C$ $^\circ C$ $^\circ C$ $^\circ C/W$ $^\circ C/W$ $^\circ C/W$ $^\circ C/W$ $^\circ C/W$ $^\circ C/W$ |

* Specifications the same as OPA137N, U, P.

NOTE: (1) At minimum power supply voltage inputs must be biased above ground in accordance with common-mode voltage range restrictions—see “Operating Voltage” discussion.

ABSOLUTE MAXIMUM RATINGS⁽¹⁾

| | |
|---|--------------------------|
| Supply Voltage, V+ to V- | 36V |
| Input Voltage | (V-) -0.7V to (V+) +0.7V |
| Input Current | 2mA |
| Output Short-Circuit ⁽²⁾ | Continuous |
| Operating Temperature | -55°C to +125°C |
| Storage Temperature | -55°C to +125°C |
| Junction Temperature | +150°C |
| Lead Temperature (soldering, 10s) | 300°C |

NOTE: (1) Stresses above these ratings may cause permanent damage. Exposure to absolute maximum ratings for extended periods may affect device reliability. (2) Short circuit to ground, one amplifier per package.



ELECTROSTATIC DISCHARGE SENSITIVITY

This integrated circuit can be damaged by ESD. Burr-Brown recommends that all integrated circuits be handled with appropriate precautions. Failure to observe proper handling and installation procedures can cause damage.

ESD damage can range from subtle performance degradation to complete device failure. Precision integrated circuits may be more susceptible to damage because very small parametric changes could cause the device not to meet its published specifications.

PACKAGE/ORDERING INFORMATION

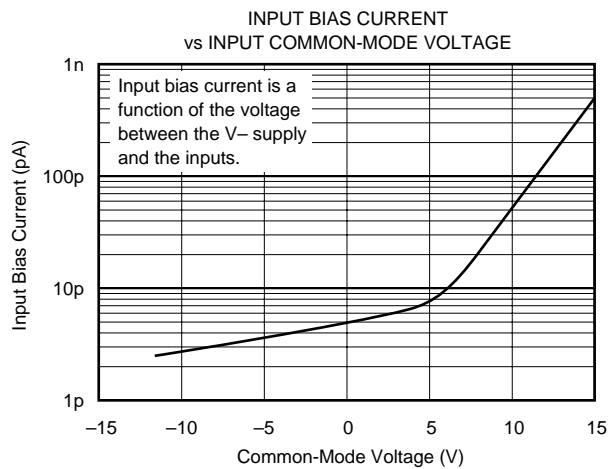
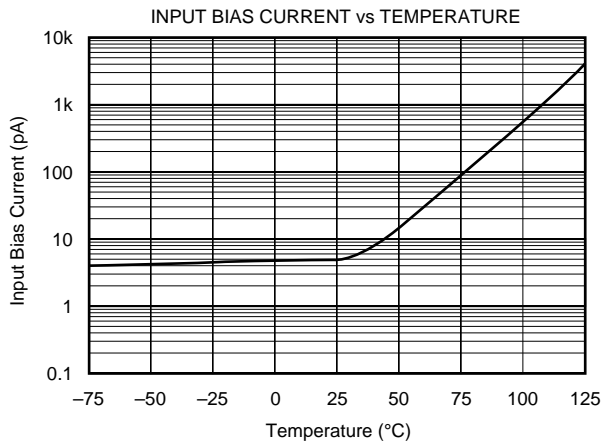
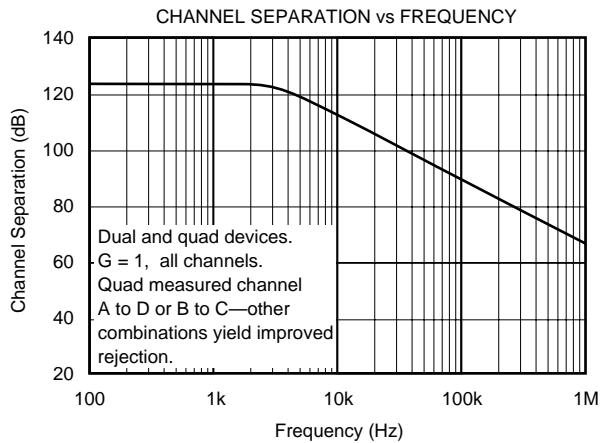
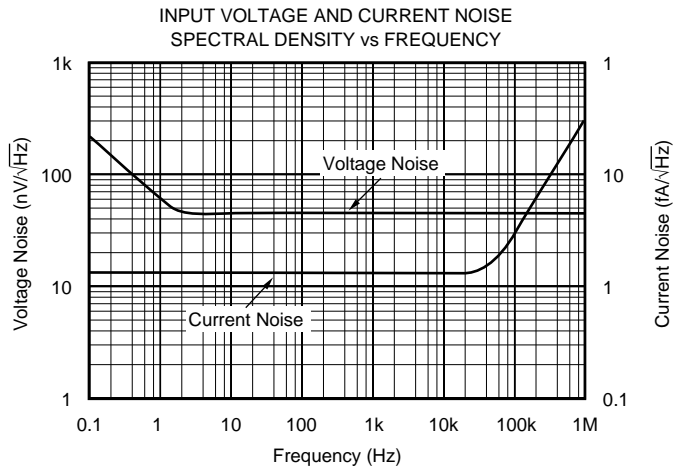
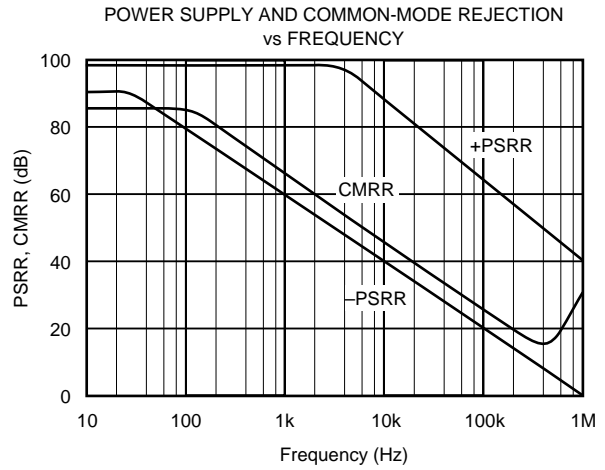
| PRODUCT | PACKAGE | PACKAGE DRAWING NUMBER ⁽¹⁾ | SPECIFIED TEMPERATURE RANGE | PACKAGE MARKING | ORDERING NUMBER ⁽²⁾ | TRANSPORT MEDIA |
|---------------|-------------------------------|---------------------------------------|-----------------------------|--------------------|--------------------------------|-----------------|
| Single | | | | | | |
| OPA137N | 5-Lead SOT-23-5 Surface Mount | 331 | -40°C to +85°C | E37 ⁽³⁾ | OPA137N/250 | Tape and Reel |
| " | " | " | " | " | OPA137N/3K | Tape and Reel |
| OPA137NA | 5-Lead SOT-23-5 Surface Mount | 331 | -40°C to +85°C | E37 ⁽³⁾ | OPA137NA/250 | Tape and Reel |
| " | " | " | " | " | OPA137NA/3K | Tape and Reel |
| OPA137U | SO-8 Surface Mount | 182 | -40°C to +85°C | OPA137U | OPA137U | Rails |
| " | " | " | " | " | OPA137U/2K5 | Tape and Reel |
| OPA137UA | SO-8 Surface Mount | 182 | -40°C to +85°C | OPA137UA | OPA137UA | Rails |
| " | " | " | " | " | OPA137UA/2K5 | Tape and Reel |
| OPA137P | 8-Pin DIP | 006 | -40°C to +85°C | OPA137P | OPA137P | Rails |
| OPA137PA | 8-Pin DIP | 006 | -40°C to +85°C | OPA137PA | OPA137PA | Rails |
| Dual | | | | | | |
| OPA2137E | MSOP-8 Surface Mount | 337 | -40°C to +85°C | E37 ⁽³⁾ | OPA2137E/250 | Tape and Reel |
| " | " | " | " | " | OPA2137E/2K5 | Tape and Reel |
| OPA2137EA | MSOP-8 Surface Mount | 337 | -40°C to +85°C | E37 ⁽³⁾ | OPA2137EA/250 | Tape and Reel |
| " | " | " | " | " | OPA2137EA/2K5 | Tape and Reel |
| OPA2137U | SO-8 Surface Mount | 182 | -40°C to +85°C | OPA2137U | OPA2137U | Rails |
| " | " | " | " | " | OPA2137U/2K5 | Tape and Reel |
| OPA2137UA | SO-8 Surface Mount | 182 | -40°C to +85°C | OPA2137UA | OPA2137UA | Rails |
| " | " | " | " | " | OPA2137UA/2K5 | Tape and Reel |
| OPA2137P | 8-Pin DIP | 006 | -40°C to +85°C | OPA2137P | OPA2137P | Rails |
| OPA2137PA | 8-Pin DIP | 006 | -40°C to +85°C | OPA2137PA | OPA2137PA | Rails |
| Quad | | | | | | |
| OPA4137U | SO-14 Surface Mount | 235 | -40°C to +85°C | OPA4137U | OPA4137U | Rails |
| " | " | " | " | " | OPA4137U/2K5 | Tape and Reel |
| OPA4137UA | SO-14 Surface Mount | 235 | -40°C to +85°C | OPA4137UA | OPA4137UA | Rails |
| " | " | " | " | " | OPA4137UA/2K5 | Tape and Reel |
| OPA4137P | 14-Pin DIP | 010 | -40°C to +85°C | OPA4137P | OPA4137P | Rails |
| OPA4137PA | 14-Pin DIP | 010 | -40°C to +85°C | OPA4137PA | OPA4137PA | Rails |

NOTES: (1) For detailed drawing and dimension table, please see end of data sheet, or Appendix C of Burr-Brown IC Data Book. (2) Models with a slash (/) are available only in Tape and Reel in the quantities indicated (e.g., /2K5 indicates 2500 devices per reel). Ordering 3000 pieces of "OPA137NA/3K" will get a single 3000-piece Tape and Reel. For detailed Tape and Reel mechanical information, refer to Appendix B of Burr-Brown IC Data Book. (3) Grade information is marked on the reel.

The information provided herein is believed to be reliable; however, BURR-BROWN assumes no responsibility for inaccuracies or omissions. BURR-BROWN assumes no responsibility for the use of this information, and all use of such information shall be entirely at the user's own risk. Prices and specifications are subject to change without notice. No patent rights or licenses to any of the circuits described herein are implied or granted to any third party. BURR-BROWN does not authorize or warrant any BURR-BROWN product for use in life support devices and/or systems.

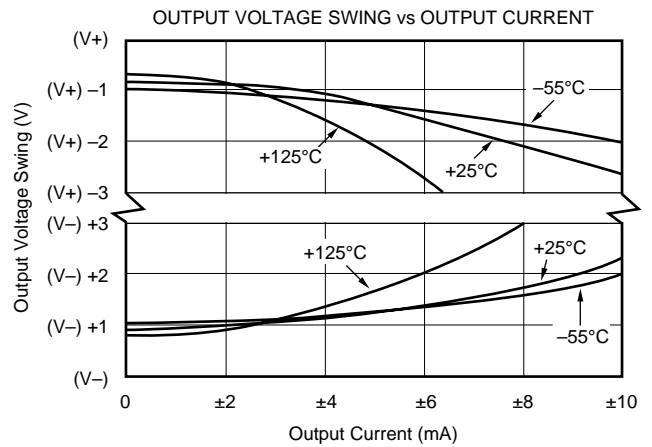
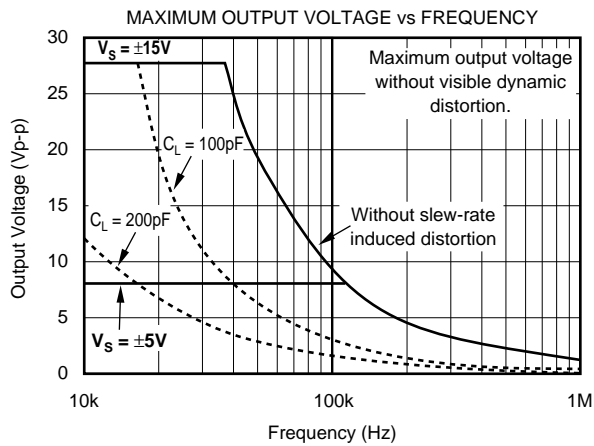
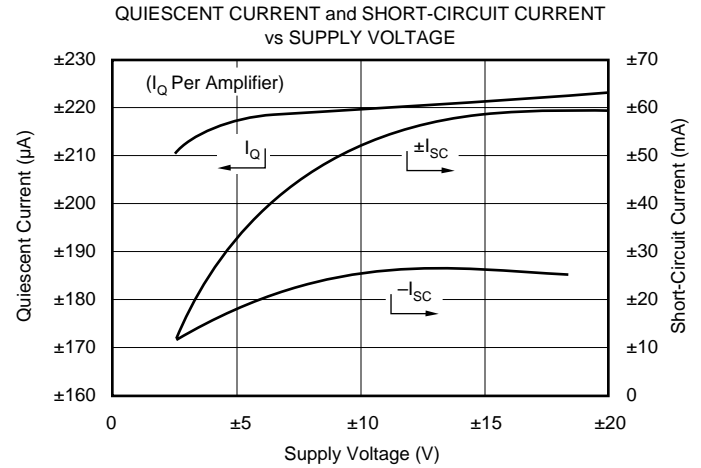
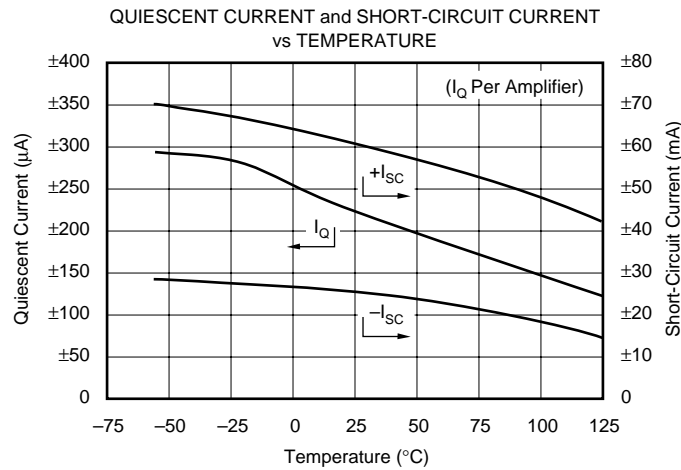
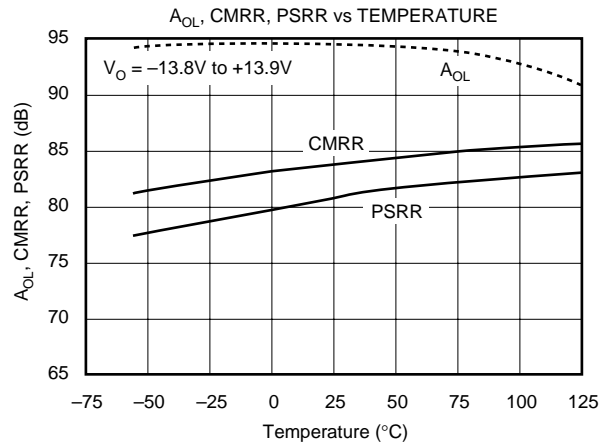
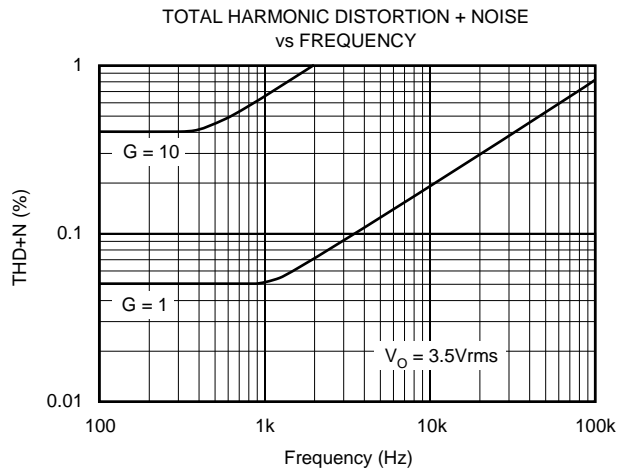
TYPICAL PERFORMANCE CURVES

At $T_A = +25^\circ\text{C}$, $V_S = \pm 15\text{V}$, $R_L = 10\text{k}\Omega$, connected to ground, unless otherwise noted.



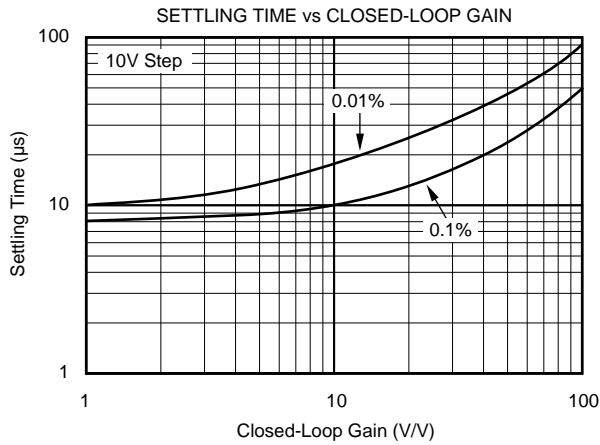
TYPICAL PERFORMANCE CURVES (CONT)

At $T_A = +25^\circ\text{C}$, $V_S = \pm 15\text{V}$, $R_L = 10\text{k}\Omega$, connected to ground, unless otherwise noted.



TYPICAL PERFORMANCE CURVES (CONT)

At $T_A = +25^\circ\text{C}$, $V_S = \pm 15\text{V}$, $R_L = 10\text{k}\Omega$, connected to ground, unless otherwise noted.



APPLICATIONS INFORMATION

OPA137 series op amps are unity-gain stable and suitable for a wide range of general-purpose applications. Power supply pins should be bypassed with 10nF ceramic capacitors or larger. All circuitry is completely independent in dual and quad versions, assuring normal performance when one amplifier in a package is overdriven or short circuited. Many key parameters are guaranteed over the specified temperature range, -40°C to $+85^{\circ}\text{C}$.

OPERATING VOLTAGE

OPA137 op amps can be operated on power supplies as low as $\pm 2.25\text{V}$. Performance remains excellent with power supplies ranging from $\pm 2.25\text{V}$ to $\pm 18\text{V}$ ($+4.5\text{V}$ to $+36\text{V}$ single supply). Most parameters vary only slightly throughout this supply voltage range. Quiescent current and short-circuit current vs supply voltage are shown in Typical Performance Curves.

Operation at very low supply voltage ($V_S \leq \pm 3\text{V}$) requires careful attention to ensure that the common-mode voltage remains within the linear range, $V_{CM} = (V-) + 3\text{V}$ to $(V+)$. Inputs may need to be biased above ground in accordance with the common-mode voltage range restrictions for linear operation.

INPUT VOLTAGE

The input common-mode voltage range of OPA137 series op amps extends from $(V-) + 3\text{V}$ to the positive rail, $V+$. For normal operation, inputs should be limited to this range. The inputs may go beyond the power supplies without output phase-reversal. Many FET-input op amps (such as TL061 types) exhibit phase-reversal of the output when the input common-mode range is exceeded. This can occur in voltage-follower circuits, causing serious problems in control loop applications.

Input terminals are diode-clamped to the power supply rails for ESD protection. If the input voltage can exceed the negative supply by 500mV, input current should be limited to 2mA (or less). If the input current is not adequately limited, you may see unpredictable behavior in the other amplifiers in the package. This is easily accomplished with an input resistor as shown in Figure 1. Many input signals are inherently current-limited, therefore, a limiting resistor may not be required.

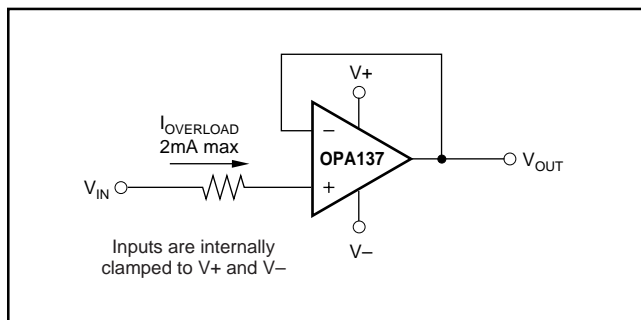


FIGURE 1. Input Current Protection for Voltages Exceeding the Supply Voltage.

HIGH-SIDE CURRENT SENSING

Many applications require the sensing of signals near the positive supply. The common-mode input range of OPA137 op amps includes the positive rail, enabling them to be used to sense power supply currents as shown in Figure 2.



FIGURE 2. High-Side Current Monitor.

INPUT BIAS CURRENT

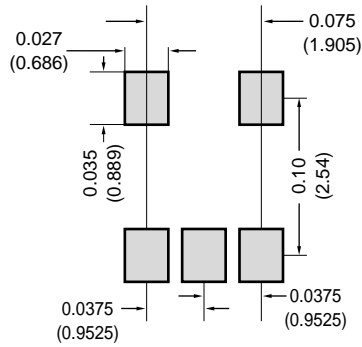
The input bias current is approximately 5pA at room temperature and increases with temperature as shown in the typical performance curve “Input Bias Current vs Temperature.”

Input Bias current also varies with common-mode voltage and power supply voltage. This variation is dependent on the voltage between the negative power supply and the common-mode input voltage. The effect is shown in the typical performance curve “Input Bias Current vs Common-Mode Voltage.”

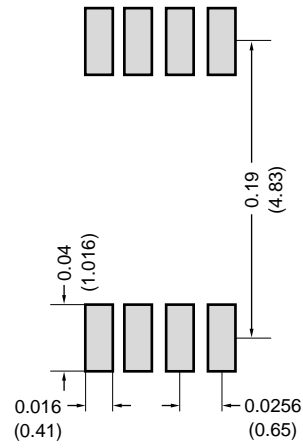


FIGURE 3. Photodetector Amplifier.

SOT-23-5
(Package Drawing #331)



MSOP-8
(Package Drawing #337)



Refer to end of data sheet or Appendix C of Burr-Brown Data Book for tolerances and detailed package drawing. For further information on solder pads for surface-mount devices consult Application Bulletin AB-132.

FIGURE 4. Recommended SOT-23-5 and MSOP-8 Solder Footprints.

IMPORTANT NOTICE

Texas Instruments and its subsidiaries (TI) reserve the right to make changes to their products or to discontinue any product or service without notice, and advise customers to obtain the latest version of relevant information to verify, before placing orders, that information being relied on is current and complete. All products are sold subject to the terms and conditions of sale supplied at the time of order acknowledgment, including those pertaining to warranty, patent infringement, and limitation of liability.

TI warrants performance of its semiconductor products to the specifications applicable at the time of sale in accordance with TI's standard warranty. Testing and other quality control techniques are utilized to the extent TI deems necessary to support this warranty. Specific testing of all parameters of each device is not necessarily performed, except those mandated by government requirements.

Customers are responsible for their applications using TI components.

In order to minimize risks associated with the customer's applications, adequate design and operating safeguards must be provided by the customer to minimize inherent or procedural hazards.

TI assumes no liability for applications assistance or customer product design. TI does not warrant or represent that any license, either express or implied, is granted under any patent right, copyright, mask work right, or other intellectual property right of TI covering or relating to any combination, machine, or process in which such semiconductor products or services might be or are used. TI's publication of information regarding any third party's products or services does not constitute TI's approval, warranty or endorsement thereof.