

SWITCHING REGULATOR CONTROL IC

■GENERAL DESCRIPTION

The **NJM2377** is a high speed low voltage operation switching regulator control IC.

It features a totem pole driver circuit that can directly drive an external Bipolar transistor.

The **NJM2377** is suitable for portable applications, including TFT panel supply with fly-back configuration.

■PACKAGE OUTLINE

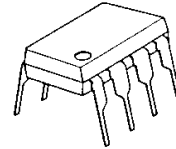

NJM2377D

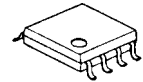

NJM2377M



NJM2377V



NJM2377R

■FEATURES

- PWM switching control
- Operating Voltage (2.7 to 18V)
- Wide Oscillator Range (10 to 500 kHz)
- ON/OFF Maximum Duty Cycle (Ton:Toff = 9:1)
- Totem Pole Output
- Soft-Start Function
- UVLO (Under Voltage Lockout)
- Bipolar Technology
- Package Outline DIP8, DMP8, SSOP8, VSP8

■BLOCK DIAGRAM

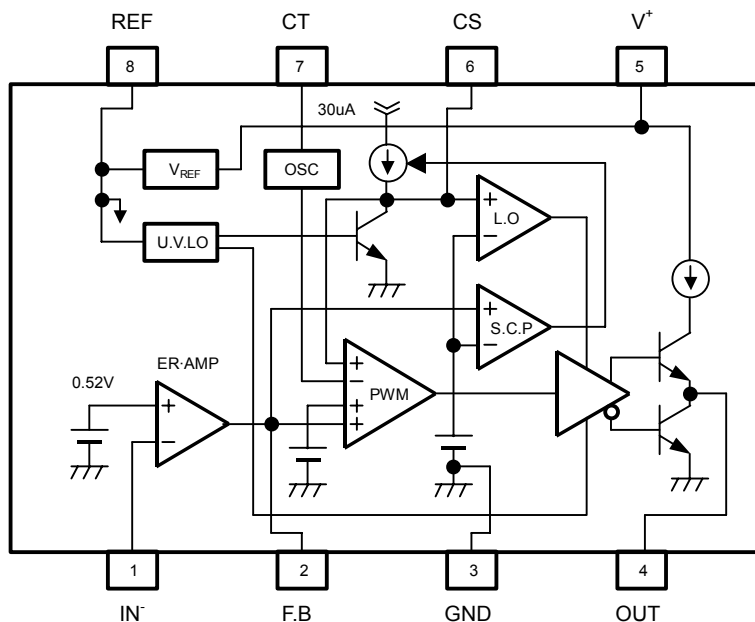

PIN FUNCTION

1. IN⁻
2. F.B
3. GND
4. OUT
5. V⁺
6. CS
7. CT
8. REF

NJM2377

■ABSOLUTE MAXIMUM RATINGS (Ta=25°C)

PARAMETER	SYMBOL	MAXIMUM RATINGS	UNIT
Input Voltage	V ⁺	18	V
Output Current	I _O	±50	mA
Power Dissipation	P _D	(DIP 8) 700 (DMP 8) 300 (SSOP 8) 250 (VSP 8) 320	mW
Operating Temperature Range	T _{OPR}	-40 ~ +85	°C
Storage Temperature Range	T _{STG}	-50 ~ +125	°C

■RECOMEND OPERATING CONDITIONS (V⁺=3V, Ta=25°C)

PARAMETER	SYMBOL	MIN.	MAX.	UNIT
Operating Voltage	V ⁺	2.7	18	V
Feed Back Resistor	R _{NF}	100	—	kΩ
Oscillator Timing Capacitor	C _T	220	22,000	pF
Oscillator Timing Resistor	R _T	5	100	kΩ
Oscillation Frequency	f _{OSC}	10	500	kHz

■ ELECTRICAL CHARACTERISTICS ($V^+=3V, R_T=39k\Omega, C_T=470pF, T_a=25^\circ C$)

REFERENCE VOLTAGE BLOCK

PARAMETER	SYMBOL	TEST CONDITION	MIN.	TYP.	MAX.	UNIT
Output Voltage	V_{REF}	$I_{OR}=1mA$	1.47	1.50	1.53	V
Line Regulation	$\Delta V_O - V_{IN}$	$V^+=2.7 \sim 18V, I_{OR}=1mA$	–	3.8	11.5	mV
Load Regulation	$\Delta V_O - I_O$	$I_{OR}=0.1 \sim 5.0mA$	–	5	30	mV

OSCILLATOR BLOCK

PARAMETER	SYMBOL	TEST CONDITION	MIN.	TYP.	MAX.	UNIT
Oscillation Frequency	f_{OSC}	$R_T=39k\Omega, C_T=470pF$	80	100	120	kHz
Oscillate Fluctuations1 (Line Fluctuations)	f_{dV}	$V^+=2.7 \sim 18V$	–	1	–	%
Oscillate Fluctuations2 (Temp Fluctuations)	f_{dT}	$T_a=-40^\circ C \sim +85^\circ C$	–	5	–	%

ERROR AMPLIFIER BLOCK

PARAMETER	SYMBOL	TEST CONDITION	MIN.	TYP.	MAX.	UNIT
Reference Voltage	V_B		0.51	0.52	0.53	V
Input Bias Voltage	I_B		–	5	100	nA
Open Loop Gain	A_V		–	90	–	dB
Gain Bandwidth Product	G_B		–	1.0	–	MHz
Maximum Output Voltage (F.B Pin)	V_{OM+}	$R_{NF}=100k\Omega, I_{N^-} Pin=0V$	1.9	2.2	2.4	V
	V_{OM-}	$R_{NF}=100k\Omega, I_{N^-} Pin=0V$	–	–	200	mV
Output Source Current (F.B Pin)	I_{OM+}	$V_{OM}=1V, I_{N^-} Pin=0V$	40	85	200	μA

PWM COMPARE BLOCK

PARAMETER	SYMBOL	TEST CONDITION	MIN.	TYP.	MAX.	UNIT
Input Threshold Voltage (F.B Pin)	V_{TH0}	duty·cycle=0%	–	0.45	0.65	V
Input Threshold Voltage (F.B Pin)	V_{TH80}	duty·cycle=80%	–	1.05	–	V
Maximum Duty Cycle	αM	F.B Pin=1.2V $R_T=39k\Omega, C_T=470pF$	80	90	–	%

SOFT START CIRCUIT BLOCK

PARAMETER	SYMBOL	TEST CONDITION	MIN.	TYP.	MAX.	UNIT
Input Bias Current (CS Pin)	I_{BCS}		–	250	650	nA
Input Threshold Voltage (CS Pin)	V_{THCS0}	duty·cycle=0%, F.B Pin=1.2V	–	0.25	0.35	V
Input Threshold Voltage (CS Pin)	V_{THCS80}	duty·cycle=80%, F.B Pin=1.2V	–	0.79	–	V

NJM2377

■ELECTRICAL CHARACTERISTICS ($V^+=3V, R_T=39k\Omega, C_T=470pF, T_a=25^\circ C$)

SHORT CIRCUIT PROTECTION

PARAMETER	SYMBOL	TEST CONDITION	MIN.	TYP.	MAX.	UNIT
Input Threshold Voltage (F.B Pin)	V_{THPC}		1.30	1.50	1.80	V
Charge Current (CS Pin)	I_{CHG}	CS Pin=0V, F.B Pin=2V	10	30	50	μA
Latch Mode Threshold Voltage (CS Pin)	V_{THLA}		1.20	1.50	1.80	V

UNDER VOLTAGE LOCKOUT

PARAMETER	SYMBOL	TEST CONDITION	MIN.	TYP.	MAX.	UNIT
ON Threshold Voltage	V_{THON}		–	1.95	–	V
OFF Threshold Voltage	V_{THOFF}		–	1.78	–	V
Hysteresis Voltage	V_{HYS}		60	170	–	mV

OUTPUT BLOCK

PARAMETER	SYMBOL	TEST CONDITION	MIN.	TYP.	MAX.	UNIT
H-Output Voltage (OUT Pin)	V_{OH}	$R_L=10k\Omega$	1.7	2.0	–	V
L-Output Voltage (OUT Pin)	V_{OL}	Output Sink Current=20mA	–	0.25	0.65	V
Output Source Current (OUT Pin)	I_{SOURCE}	Out Pin=0V	23	35	–	mA

GENERAL CHARACTERISTICS

PARAMETER	SYMBOL	TEST CONDITION	MIN.	TYP.	MAX.	UNIT
Quiescent Current	I_{CCLA}	Latch Mode, CS Pin=1.8V	–	1.7	2.4	mA
Average Quiescent Current	I_{CCAV}	$R_L = \infty$, duty cycle=50%	–	5.0	6.8	mA

■ TYPICAL APPLICATIONS

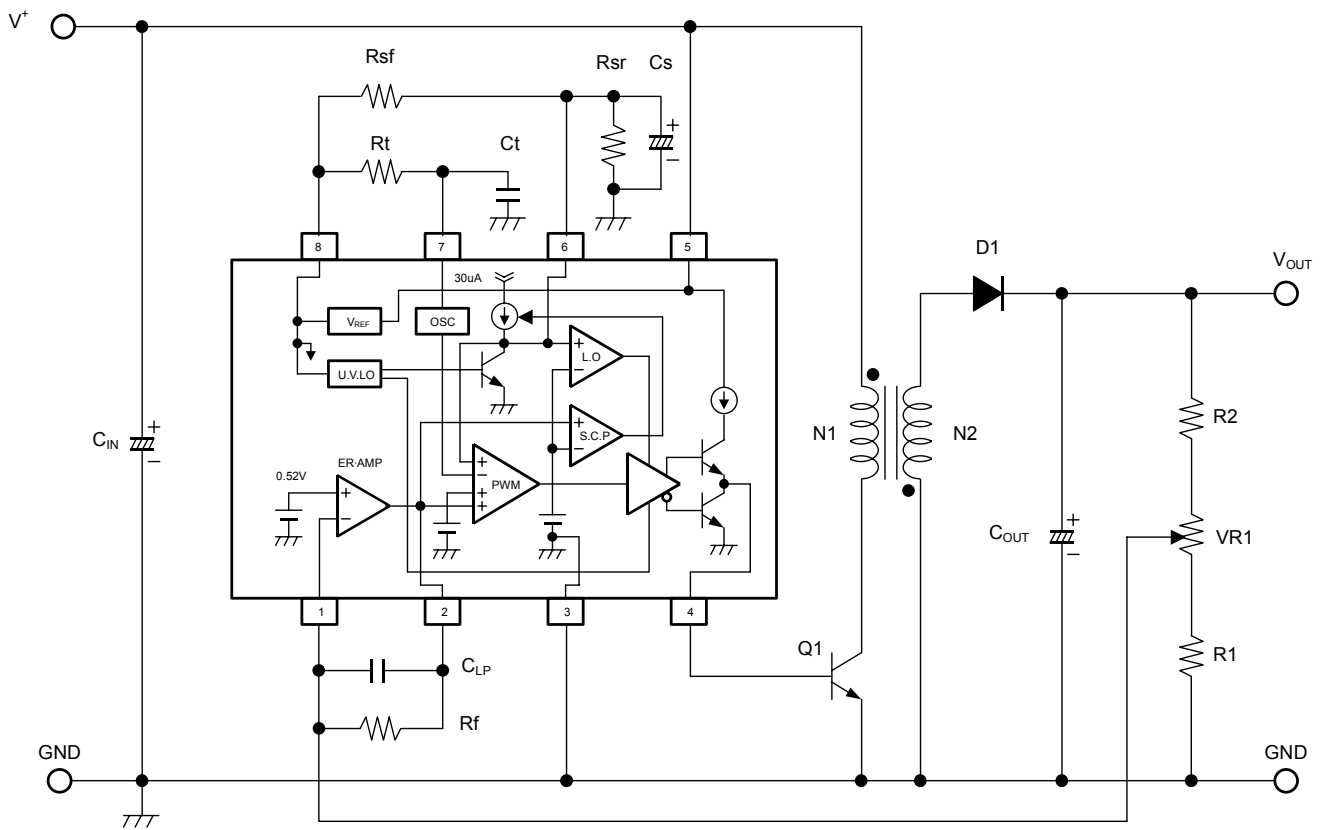

■ TYPICAL CHARACTERISTICS

H Output Voltage(OUT Pin) vs. Source Current
($V^+=3V, C_T=0V, C_S=1V, T_a=25^\circ C$)

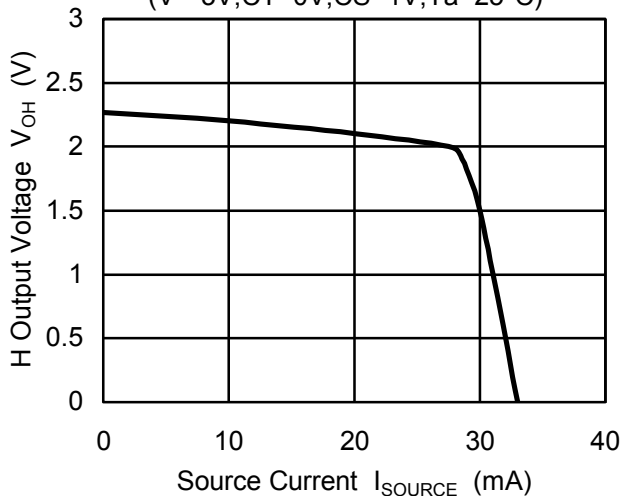

L Output Voltage(OUT Pin) vs. Sink Current
($V^+=3V, C_S=FB=0V, C_T=0.5V, T_a=25^\circ C$)

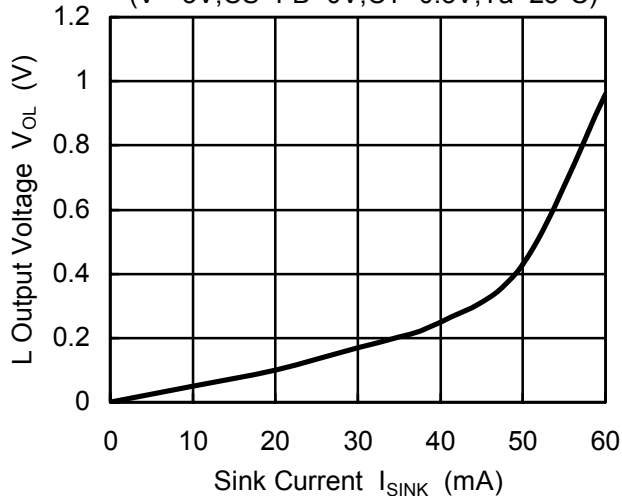

Oscillator Frequency vs. Timing Resistor
($V^+=3V, T_a=25^\circ C$)

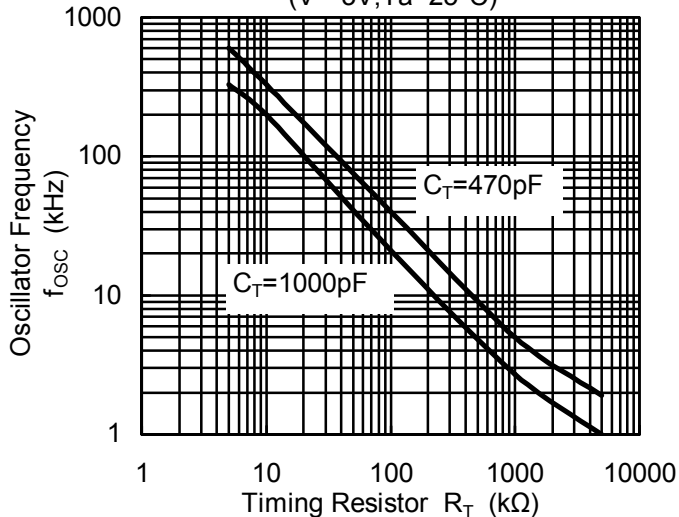

Oscillator Frequency vs. Timing Capacitor
($V^+=3V, T_a=25^\circ C$)

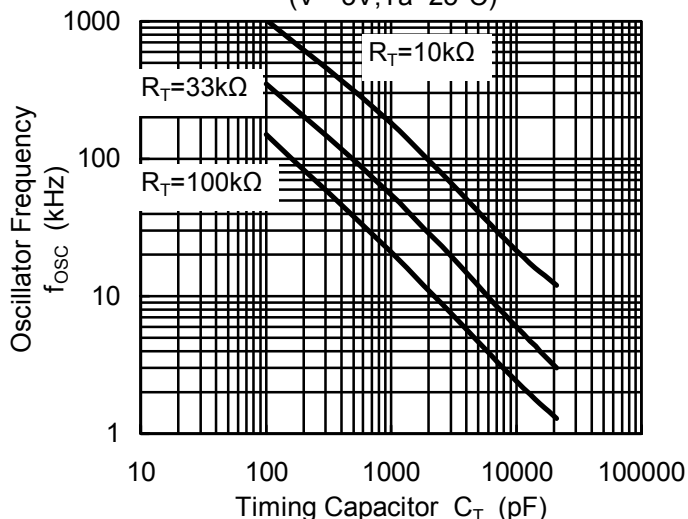

Reference Voltage vs. Output Current
($V^+=3V, T_a=25^\circ C$)

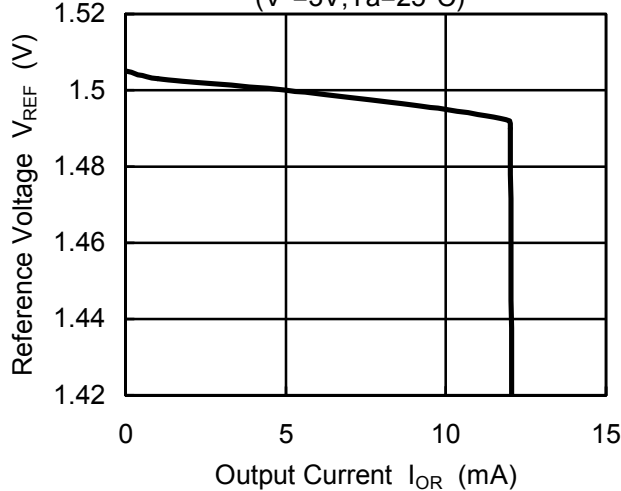

Operating Current vs. Operating Voltage
($T_a=25^\circ C$)

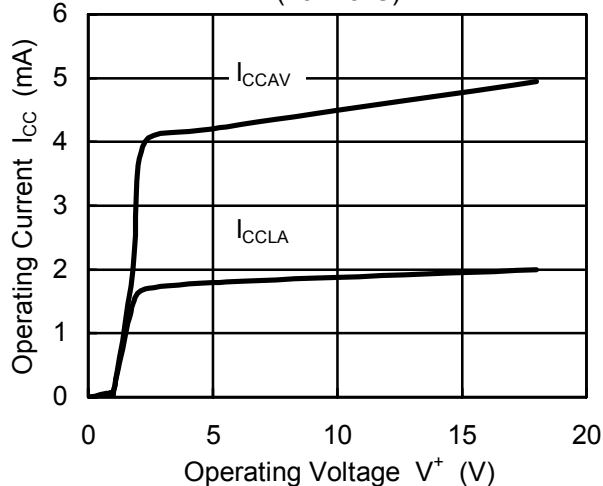

TYPICAL CHARACTERISTICS

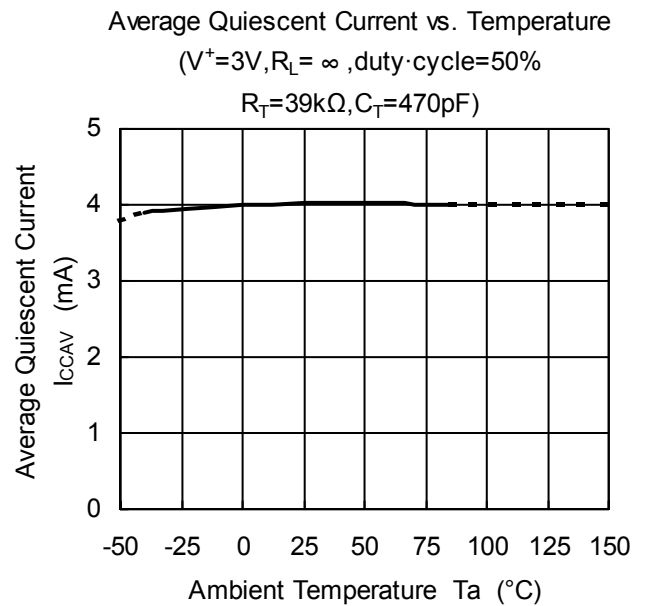
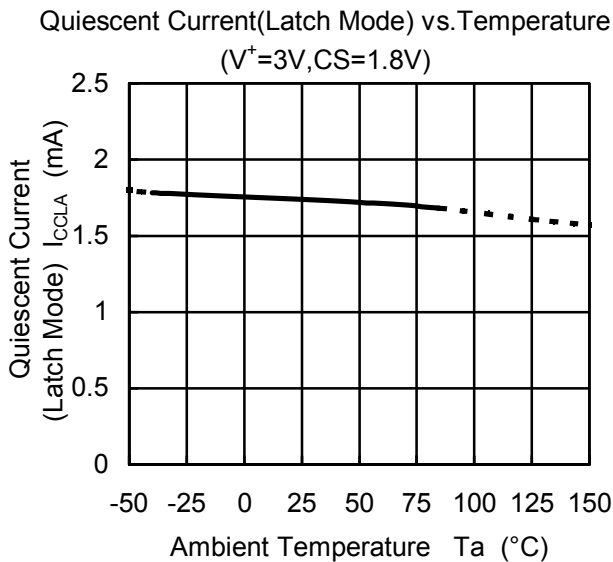
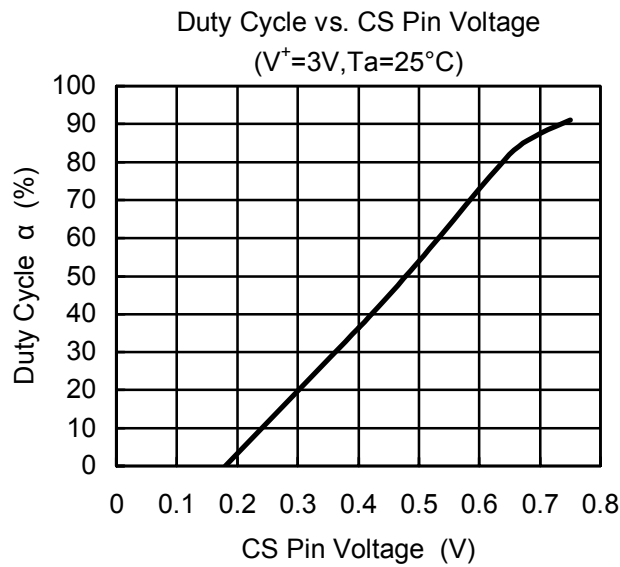
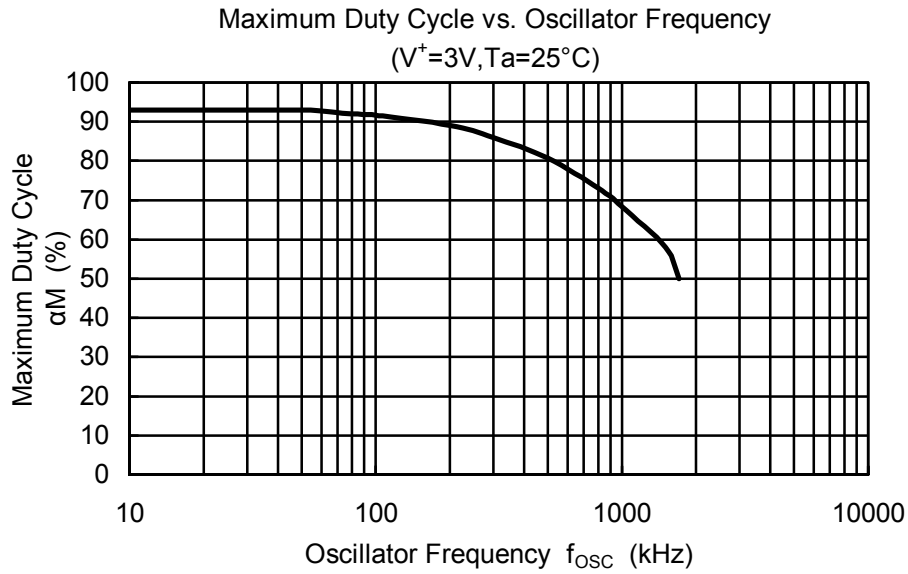

■ TYPICAL CHARACTERISTICS

Reference Voltage Block
Reference Voltage vs. Temperature
($V^+=3V, I_{OR}=1mA$)

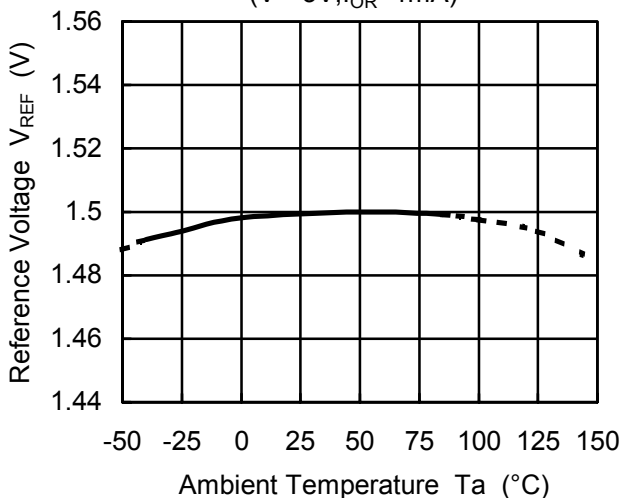

Oscillator Frequency vs. Temperature
($V^+=3V, R_T=39k\Omega, C_T=470pF$)

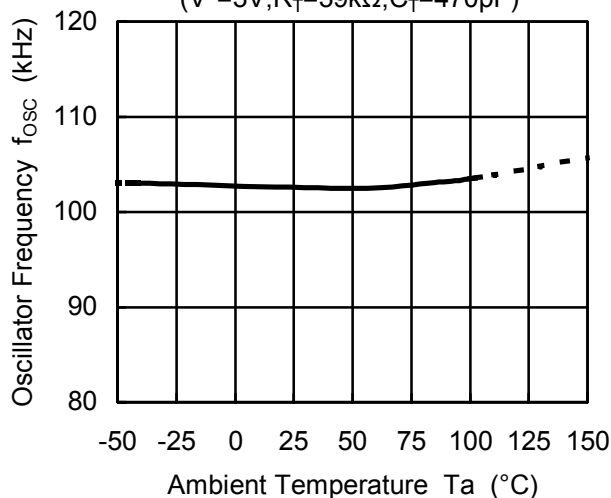

Error Amplifier Block
Reference Voltage vs. Temperature
($V^+=3V$)

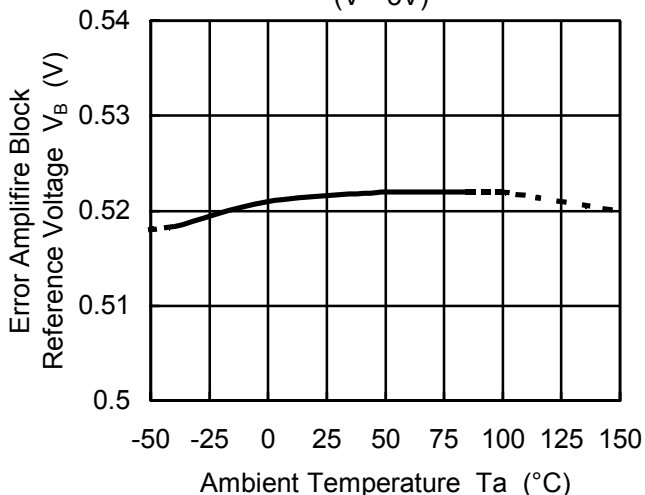

Maximum Duty Cycle vs. Temperature
($V^+=3V, R_T=39k\Omega, C_T=470pF$)

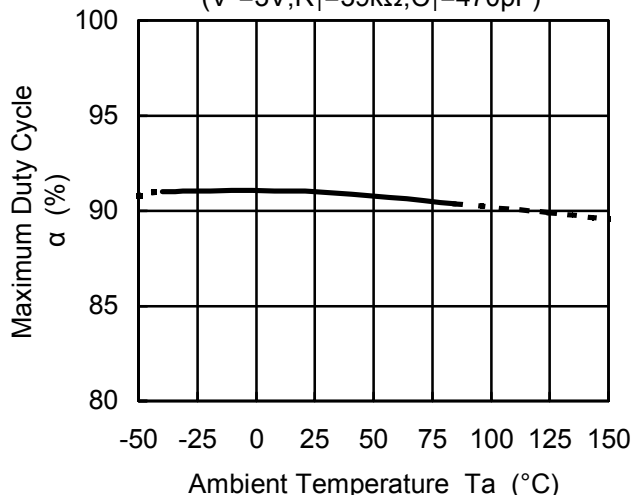

Charge Current (CS Pin) vs. Temperature
($V^+=3V, F.B \text{ Pin}=2V$)

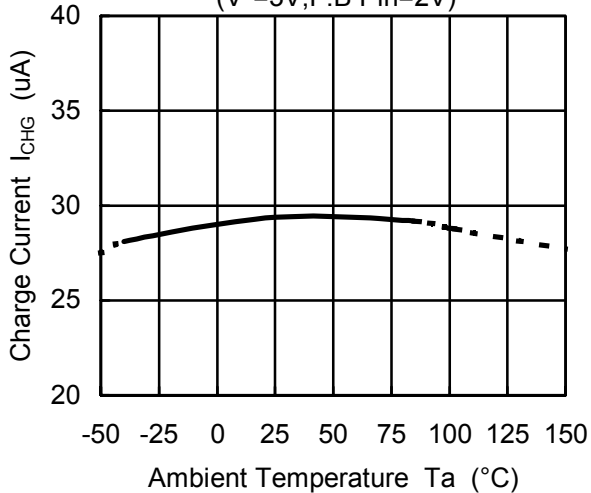

Under Voltage Lockout Block
ON/OFF Threshold Voltage vs. Temperature

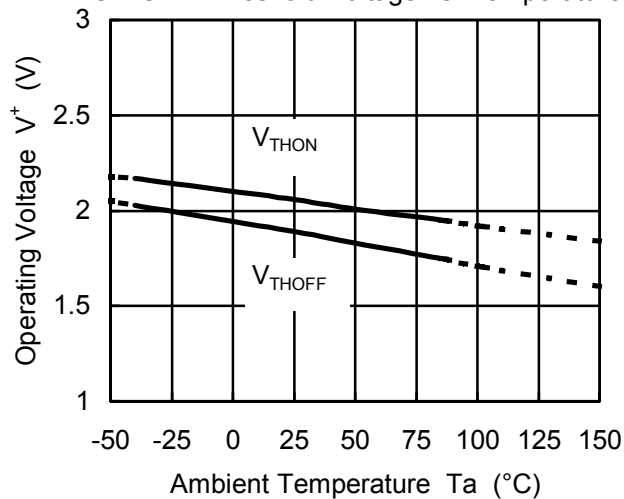

TYPICAL CHARACTERISTICS

H Output Voltage (OUT Pin) vs. Temperature
($V^+ = 3V, R_L = 10k\Omega$)

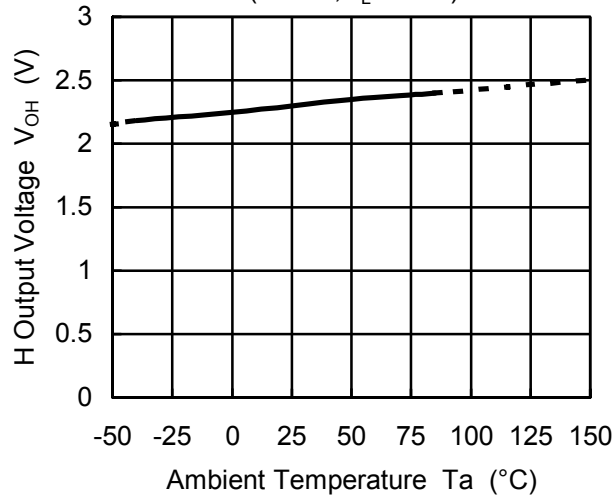

L Output Voltage (OUT Pin) vs. Temperature
($V^+ = 3V, I_{SINK} = 20mA$)

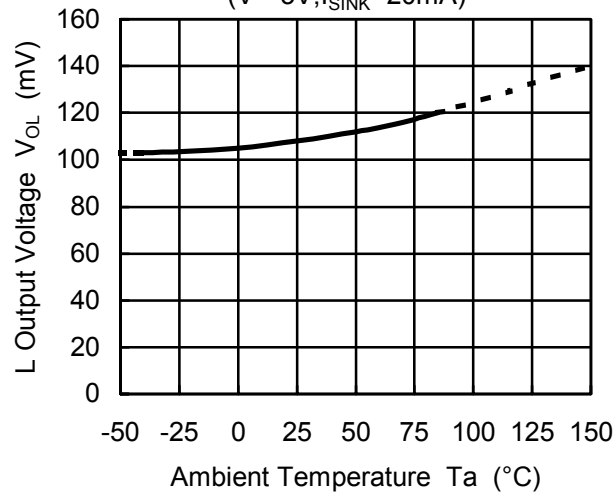

Output Source Current (OUT Pin) vs. Temperature
($V^+ = 3V, OUT\ Pin = 0V$)

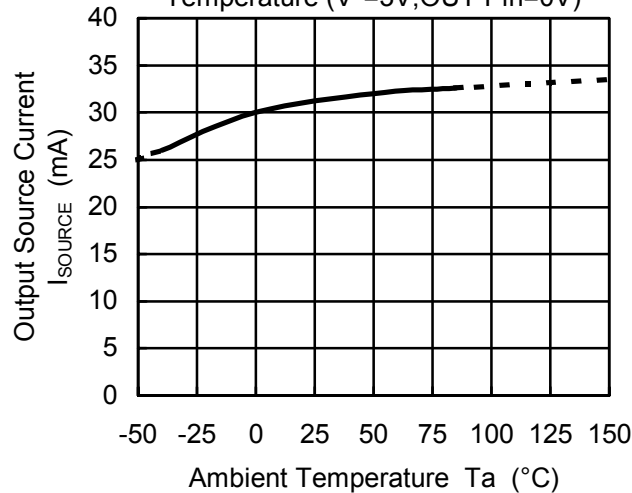

[CAUTION]

The specifications on this databook are only given for information, without any guarantee as regards either mistakes or omissions. The application circuits in this databook are described only to show representative usages of the product and not intended for the guarantee or permission of any right including the industrial rights.