

## Microcontroller Supervisory Circuit with Open Drain Output

### FEATURES

- Holds microcontroller in reset until supply voltage reaches stable operating level
- Resets microcontroller during power loss
- Precision monitoring of 3V, 3.3V, and 5V systems
- 7 voltage trip points available
- Active low RESET pin
- Open drain output
- Internal pullup resistor (5K $\Omega$ ) for MCP130
- Holds RESET for 350 ms (typical)
- Guaranteed RESET to  $V_{CC} = 1.0V$
- Accuracy of  $\pm 125mV$  for 5V systems and  $\pm 75mV$  for 3V systems over temperature
- 45  $\mu A$  typical operating current
- Temperature range:
  - Industrial (I): -40°C to +85°C

### DESCRIPTION

The Microchip Technology Inc. MCP120/130 is a voltage supervisory device designed to keep a microcontroller in reset until the system voltage has reached the proper level and stabilized. It also operates as protection from brown-out conditions when the supply voltage drops below a safe operating level. Both devices are available with a choice of seven different trip voltages and both have open drain outputs. The MCP130 has an internal 5K $\Omega$  pullup resistor. Both devices have active low RESET pins. The MCP120/130 will assert the RESET signal whenever the voltage on the  $V_{DD}$  pin is below the trip-point voltage.

### PACKAGES

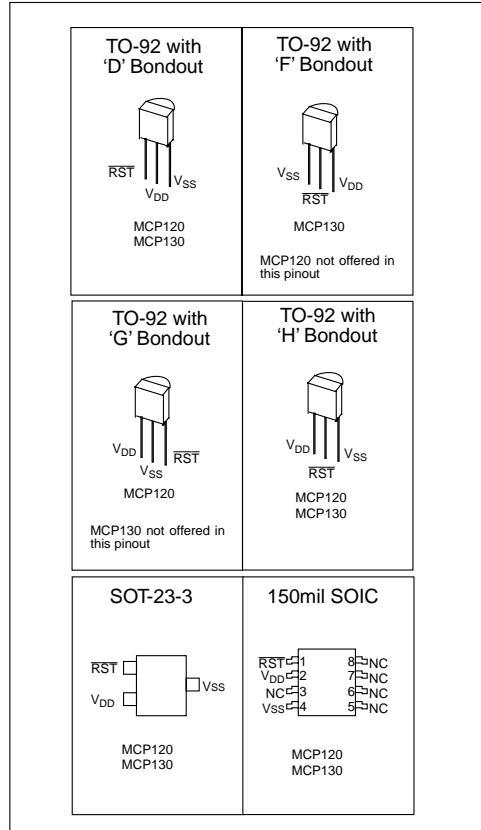

### BLOCK DIAGRAM

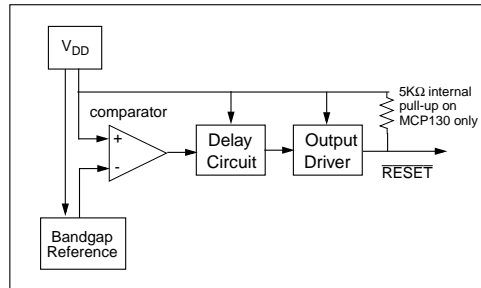

## 1.0 ELECTRICAL CHARACTERISTICS

### 1.1 Maximum Ratings\*

$V_{DD}$ .....	7.0V
All inputs and outputs w.r.t. $V_{SS}$ .....	-0.6V to $V_{DD} + 1.0V$
Storage temperature .....	-65°C to +150°C
Ambient temp. with power applied .....	-65°C to +125°C
Soldering temperature of leads (10 seconds) .....	+300°C
ESD protection on all pins .....	$\geq 2$ kV

**\*Notice:** Stresses above those listed under "Maximum Ratings" may cause permanent damage to the device. This is a stress rating only and functional operation of the device at those or any other conditions above those indicated in the operational listings of this specification is not implied. Exposure to maximum rating conditions for extended periods may affect device reliability.

## DC AND AC CHARACTERISTICS

All parameters apply at the specified temp and voltage ranges unless otherwise noted.		$V_{DD} = 1.0 - 5.5V$ Industrial (I): -40°C to +85°C					
PARAMETER		SYMBOL	MIN	TYP	MAX	UNITS	TEST CONDITIONS
Operating Voltage Range		$V_{DD}$	1.0		5.5	V	
$V_{DD}$ Value to Guarantee $\overline{RESET}$		$V_{DDMIN}$	1.0			V	
Operating Current		$I_{DD}$		45	60	$\mu A$	$V_{DD} = 5.5V$ (no load)
$V_{DD}$ Trip Point	MCP1X0-270	$V_{TRIP}$	2.55	2.625	2.7	V	
	MCP1X0-300		2.85	2.925	3.0		
	MCP1X0-315		3.0	3.075	3.15		
	MCP1X0-450		4.25	4.375	4.50		
	MCP1X0-460		4.35	4.475	4.60		
	MCP1X0-475		4.50	4.625	4.75		
	MCP1X0-485		4.60	4.725	4.85		
$\overline{RESET}$ Low Level Output Voltage	MCP1X0-270 MCP1X0-300 MCP1X0-315	$V_{OL}$			0.4	V	$I_{OL} = 3.2mA,$ $V_{DD} = V_{TRIPMIN}$
	MCP1X0-450 MCP1X0-460 MCP1X0-475 MCP1X0-485				0.6		
$\overline{RESET}$ High Level Output Voltage (MCP130 Only)	MCP130-XXX (All $V_{TRIP}$ Points)	$V_{OH}$	$V_{DD}-0.7$			V	$I_{OH} = 50\mu A, V_{DD} > V_{TRIPMAX}$
Pullup Resistor (MCP130 Only)				5		$k\Omega$	
Output Leakage (MCP120 Only)				1		$\mu A$	
Threshold Hysteresis		$V_{HYS}$		50		mV	
$V_{DD}$ Detect to $\overline{RESET}$ Inactive		$t_{RPU}$	150	350	700	ms	
$V_{DD}$ Detect to $\overline{RESET}$		$t_{RPD}$		10		$\mu s$	$V_{DD}$ ramped from $V_{TRIPMAX} + 250mV$ down to $V_{TRIPMIN} - 250mV$
<b>Note:</b> Typical values are for 25°C and $V_{DD} = 5.0V$							

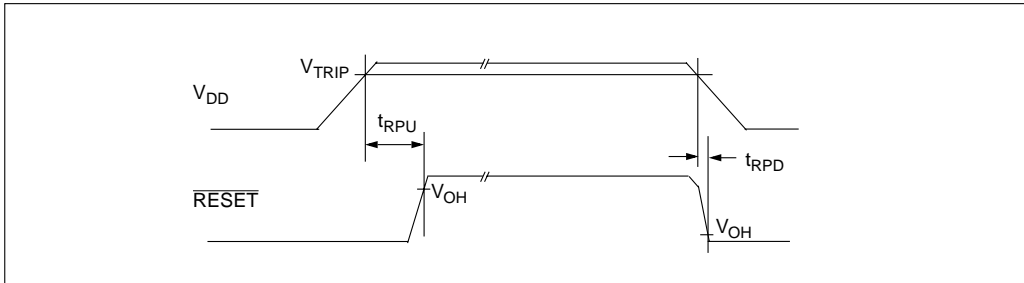
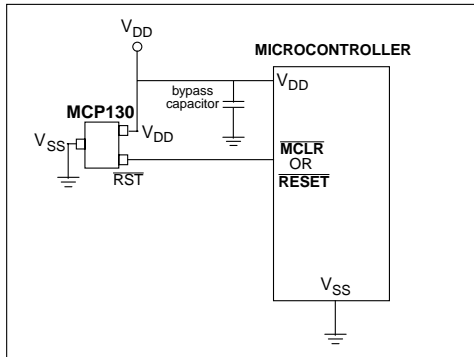

**FIGURE 1:** MCP120/130 Timing Diagram

## 2.0 APPLICATIONS INFORMATION

### 2.1 The Need for Supervisory Circuits

For many of today's microcontroller applications, care must be taken to prevent low power conditions that can cause many different system problems. The most common causes are brown-out conditions where the system supply drops below the operating level momentarily, and the second, is when a slowly decaying power supply causes the microcontroller to begin executing instructions without enough voltage to sustain SRAM and producing indeterminate results.



**FIGURE 2-1:** Typical Application

### 2.2 Negative Going $V_{DD}$ Transients

Many system designers implementing POR circuits are concerned about the minimum pulse width required to cause a reset. Figure 2-2 shows typical transient voltage below the trip point ( $V_{TRIP} - V_{DD}$ ) vs. transient duration. It shows that the farther below the trip point the transient pulse goes, the duration of the pulse required to cause a reset gets shorter. A 0.1  $\mu F$  bypass cap mounted as close as possible to the  $V_{DD}$  pin provides additional transient immunity.

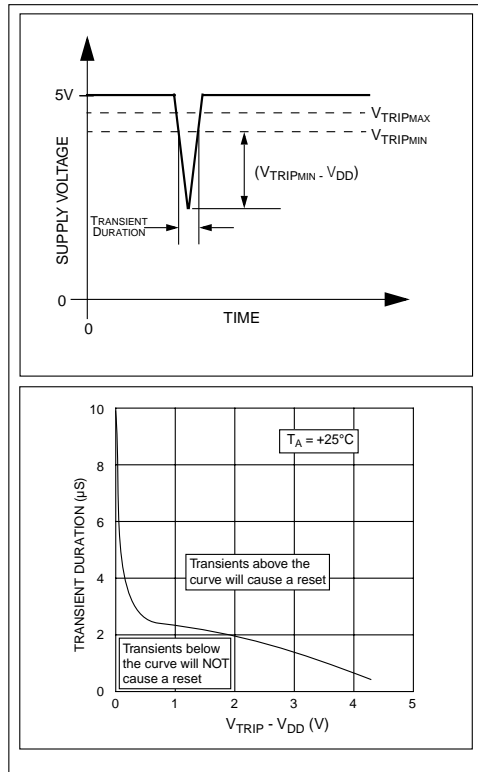

**FIGURE 2-2:** Typical Transient Response

## 2.3 Effect of Temperature on Timeout Period ( $t_{RPU}$ )

The timeout period ( $t_{RPU}$ ) determines how long the device remains in the reset condition. This is controlled by an internal RC timer and is effected by both  $V_{DD}$  and temperature. The graph shown in Figure 2-3 shows typical response for different  $V_{DD}$  values and temperatures.

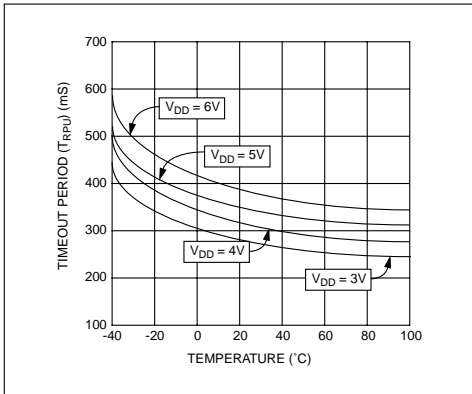

FIGURE 2-3:  $t_{RPU}$  vs. Temperature

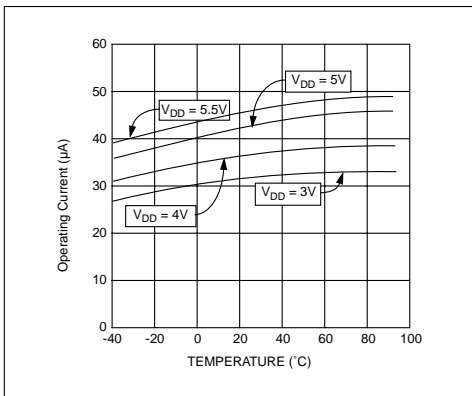

FIGURE 2-4:  $I_{DD}$  vs. Temperature

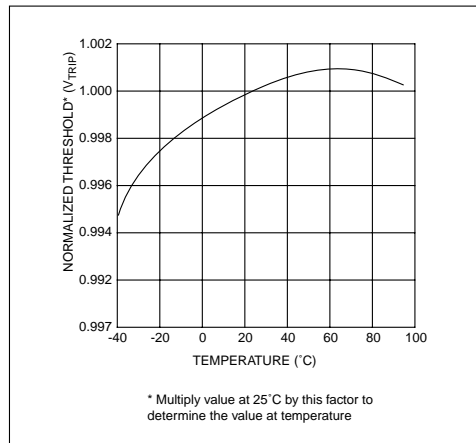

FIGURE 2-5: Normalized  $V_{TRIP}$  vs. Temperature

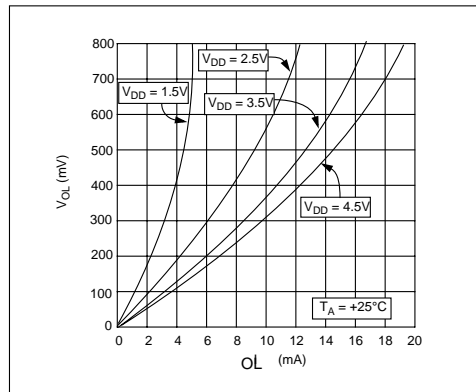

FIGURE 2-6:  $V_{OL}$  vs.  $I_{OL}$

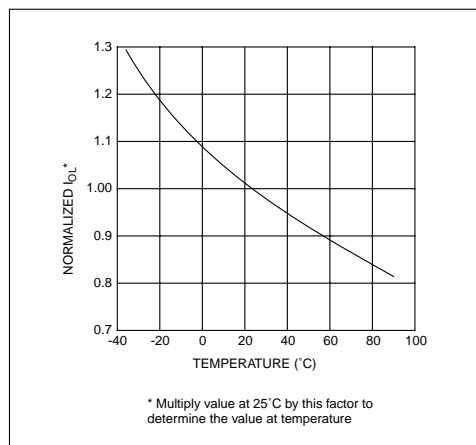

FIGURE 2-7: Normalized  $I_{OL}$  vs. Temperature

## MCP120/130 PRODUCT IDENTIFICATION SYSTEM

<p><b>MCP120/130</b> — <b>xxx b I /pp</b></p> <p><b>Package</b></p> <p><b>Temperature Range</b></p> <p><b>Bondout Option (TO-92 only)</b></p> <p><b>RESET V<sub>TRIP</sub> Voltage</b></p> <p><b>Device</b></p>	<p>TO = TO-92 (3-lead) [offered in bags only]            TT = SOT-23 (3-lead) [offered in tape &amp; reel only]            SN = SOIC (8-lead, 150 mil Body)</p> <p>I = -40°C to +85°C (only offered in I)</p> <p>D = D Bond Option (see bond option diagrams)            F = F Bond Option            G = G Bond Option            H = H Bond Option</p> <p>270 = <math>2.55 \leq V_{TRIP} \leq 2.70</math>            300 = <math>2.85 \leq V_{TRIP} \leq 3.00</math>            315 = <math>3.00 \leq V_{TRIP} \leq 3.15</math>            450 = <math>4.25 \leq V_{TRIP} \leq 4.50</math>            460 = <math>4.35 \leq V_{TRIP} \leq 4.60</math>            475 = <math>4.50 \leq V_{TRIP} \leq 4.75</math>            485 = <math>4.60 \leq V_{TRIP} \leq 4.85</math></p> <p>MCP120 = Supervisor circuit with open drain output.            MCP120T = Supervisor circuit with open drain output (tape &amp; reel).            MCP130 = Supervisor circuit with open drain output and internal pullup resistor.            MCP130T = Supervisor circuit with open drain output and internal pullup resistor (tape &amp; reel).</p>
---	---

**Product Identification Options for MCP120/130**

TO-92 with 'D' Bondout	TO-92 with 'F' Bondout	TO-92 with 'G' Bondout	TO-92 with 'H' Bondout	SOT-23-3	150mil SOIC
MCP120-XXXD I/TO MCP130-XXXD I/TO	MCP130-XXXF I/TO MCP120 not offered in this pinout	MCP120-XXXG I/TO MCP130 not offered in this pinout	MCP120-XXXH I/TO MCP130-XXXH I/TO	MCP120-XXX I/TT MCP130-XXX I/TT	MCP120-XXX I/SN MCP130-XXX I/SN

**Example of Product Identification:**

For the MCP130 (open drain output with internal pull up resistor) with V<sub>TRIP</sub> range of 2.55V - 2.70V in TO-92 package with 'F' bond option in industrial temp range, the part number would be: MCP130-270F I/TO.

### Sales and Support

#### Data Sheets

Products supported by a preliminary Data Sheet may have an errata sheet describing minor operational differences and recommended workarounds. To determine if an errata sheet exists for a particular device, please contact one of the following:

1. Your local Microchip sales office
2. The Microchip Corporate Literature Center U.S. FAX: (602) 786-7277
3. The Microchip Worldwide Site ([www.microchip.com](http://www.microchip.com))

Please specify which device, revision of silicon and Data Sheet (include Literature #) you are using.

#### New Customer Notification System

Register on our web site ([www.microchip.com/cn](http://www.microchip.com/cn)) to receive the most current information on our products.

# MCP120/130

---

---

NOTES:

**NOTES:**



**MICROCHIP**

---

---

## WORLDWIDE SALES AND SERVICE

---

---

### AMERICAS

#### Corporate Office

Microchip Technology Inc.  
2355 West Chandler Blvd.  
Chandler, AZ 85224-6199  
Tel: 602-786-7200 Fax: 602-786-7277  
Technical Support: 602 786-7627  
Web: <http://www.microchip.com>

#### Atlanta

Microchip Technology Inc.  
500 Sugar Mill Road, Suite 200B  
Atlanta, GA 30350  
Tel: 770-640-0034 Fax: 770-640-0307

#### Boston

Microchip Technology Inc.  
5 Mount Royal Avenue  
Marlborough, MA 01752  
Tel: 508-480-9990 Fax: 508-480-8575

#### Chicago

Microchip Technology Inc.  
333 Pierce Road, Suite 180  
Itasca, IL 60143  
Tel: 630-285-0071 Fax: 630-285-0075

#### Dallas

Microchip Technology Inc.  
14651 Dallas Parkway, Suite 816  
Dallas, TX 75240-8809  
Tel: 972-991-7177 Fax: 972-991-8588

#### Dayton

Microchip Technology Inc.  
Two Prestige Place, Suite 150  
Miamisburg, OH 45342  
Tel: 937-291-1654 Fax: 937-291-9175

#### Detroit

Microchip Technology Inc.  
42705 Grand River, Suite 201  
Novi, MI 48375-1727  
Tel: 248-374-1888 Fax: 248-374-2874

#### Los Angeles

Microchip Technology Inc.  
18201 Von Karman, Suite 1090  
Irvine, CA 92612  
Tel: 714-263-1888 Fax: 714-263-1338

#### New York

Microchip Technology Inc.  
150 Motor Parkway, Suite 202  
Hauppauge, NY 11788  
Tel: 516-273-5305 Fax: 516-273-5335

### AMERICAS (continued)

#### Toronto

Microchip Technology Inc.  
5925 Airport Road, Suite 200  
Mississauga, Ontario L4V 1W1, Canada  
Tel: 905-405-6279 Fax: 905-405-6253

#### San Jose

Microchip Technology Inc.  
2107 North First Street, Suite 590  
San Jose, CA 95131  
Tel: 408-436-7950 Fax: 408-436-7955

### ASIA/PACIFIC

#### Hong Kong

Microchip Asia Pacific  
RM 3801B, Tower Two  
Metroplaza  
223 Hing Fong Road  
Kwai Fong, N.T., Hong Kong  
Tel: 852-2-401-1200 Fax: 852-2-401-3431

#### India

Microchip Technology Inc.  
India Liaison Office  
No. 6, Legacy, Convent Road  
Bangalore 560 025, India  
Tel: 91-80-229-0061 Fax: 91-80-229-0062

#### Japan

Microchip Technology Intl. Inc.  
Benex S-1 6F  
3-18-20, Shinyokohama  
Kohoku-Ku, Yokohama-shi  
Kanagawa 222-0033 Japan  
Tel: 81-45-471-6166 Fax: 81-45-471-6122

#### Korea

Microchip Technology Korea  
168-1, Youngbo Bldg. 3 Floor  
Samsung-Dong, Kangnam-Ku  
Seoul, Korea  
Tel: 82-2-554-7200 Fax: 82-2-558-5934

#### Shanghai

Microchip Technology  
RM 406 Shanghai Golden Bridge Bldg.  
2077 Yan'an Road West, Hong Qiao District  
Shanghai, PRC 200335  
Tel: 86-21-6275-5700 Fax: 86 21-6275-5060

### ASIA/PACIFIC (continued)

#### Singapore

Microchip Technology Singapore Pte Ltd.  
200 Middle Road  
#07-02 Prime Centre  
Singapore 188980  
Tel: 65-334-8870 Fax: 65-334-8850

#### Taiwan, R.O.C

Microchip Technology Taiwan  
10F-1C 207  
Tung Hua North Road  
Taipei, Taiwan, ROC  
Tel: 886-2-2717-7175 Fax: 886-2-2545-0139

### EUROPE

#### United Kingdom

Arizona Microchip Technology Ltd.  
505 Eskdale Road  
Winnersh Triangle  
Wokingham  
Berkshire, England RG41 5TU  
Tel: 44-1189-21-5858 Fax: 44-1189-21-5835

#### France

Arizona Microchip Technology SARL  
Zone Industrielle de la Bonde  
2 Rue du Buisson aux Fraises  
91300 Massy, France  
Tel: 33-1-69-53-63-20 Fax: 33-1-69-30-90-79

#### Germany

Arizona Microchip Technology GmbH  
Gustav-Heinemann-Ring 125  
D-81739 München, Germany  
Tel: 49-89-627-144 0 Fax: 49-89-627-144-44

#### Italy

Arizona Microchip Technology SRL  
Centro Direzionale Colleoni  
Palazzo Taurus 1 V. Le Colleoni 1  
20041 Agrate Brianza  
Milan, Italy  
Tel: 39-39-6899939 Fax: 39-39-6899883

9/29/98

All rights reserved. © 1999 Microchip Technology Incorporated. Printed in the USA. 2/99 Printed on recycled paper.

Information contained in this publication regarding device applications and the like is intended for suggestion only and may be superseded by updates. No representation or warranty is given and no liability is assumed by Microchip Technology Incorporated with respect to the accuracy or use of such information, or infringement of patents or other intellectual property rights arising from such use or otherwise. Use of Microchip's products as critical components in life support systems is not authorized except with express written approval by Microchip. No licenses are conveyed, implicitly or otherwise, under any intellectual property rights. The Microchip logo and name are registered trademarks of Microchip Technology Inc. in the U.S.A. and other countries. All rights reserved. All other trademarks mentioned herein are the property of their respective companies.