

Microcontroller Supervisory Circuit with Push-Pull Output

FEATURES

- Holds microcontroller in reset until supply voltage reaches stable operating level
- Resets microcontroller during power loss
- Precision monitoring of 3V, 3.3V, and 5V systems
- 7 voltage trip points available
- Active low $\overline{\text{RESET}}$ pin (MCP100) or active high RESET (MCP101)
- Push-pull output
- Holds $\overline{\text{RESET}}$ /RESET for 350 ms (typical)
- Guaranteed $\overline{\text{RESET}}$ /RESET to $V_{DD} = 1.0V$
- Accuracy of $\pm 125mV$ for 5V systems and $\pm 75mV$ for 3V systems over temperature
- 45 μA typical operating current
- Temperature range:
 - Industrial (I): $-40^{\circ}C$ to $+85^{\circ}C$

DESCRIPTION

The Microchip Technology Inc. MCP100/101 is a voltage supervisory device designed to keep a microcontroller in reset until the system voltage has reached the proper level and stabilized. It also operates as protection from brown-out conditions when the supply voltage drops below a safe operating level. Both devices are available with a choice of seven different trip voltages and both have push-pull outputs. The MCP100 has a low active $\overline{\text{RESET}}$ pin and the MCP101 has a high active RESET pin. The MCP100/101 will assert the $\overline{\text{RESET}}$ /RESET signal whenever the voltage on the V_{DD} pin is below the trip-point voltage.

PACKAGES

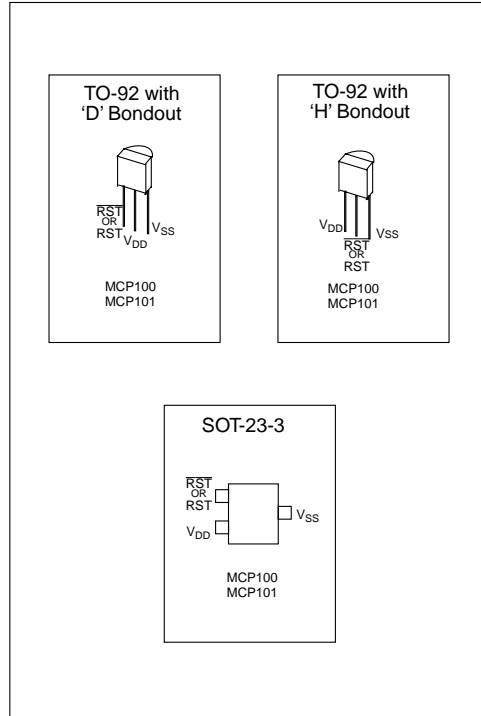

BLOCK DIAGRAM

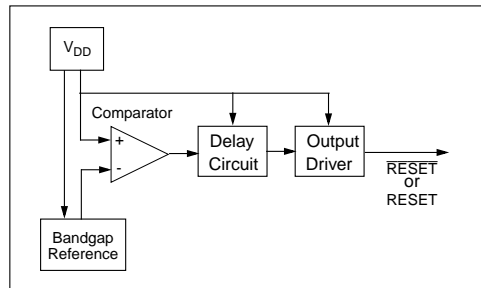

MCP100/101

1.0 ELECTRICAL CHARACTERISTICS

1.1 Maximum Ratings*

V _{DD}	7.0V
All inputs and outputs w.r.t. V _{SS}	-0.6V to V _{DD} +1.0V
Storage temperature	-65°C to +150°C
Ambient temp. with power applied.....	-65°C to +125°C
Soldering temperature of leads (10 seconds)	+300°C
ESD protection on all pins	≥ 2 kV

***Notice:** Stresses above those listed under “Maximum Ratings” may cause permanent damage to the device. This is a stress rating only and functional operation of the device at those or any other conditions above those indicated in the operational listings of this specification is not implied. Exposure to maximum rating conditions for extended periods may affect device reliability.

DC AND AC CHARACTERISTICS

All parameters apply at the specified temp and voltage ranges unless otherwise noted.		V _{DD} = 1.0 - 5.5V Industrial (I): -40°C to +85°C					
PARAMETER	SYMBOL	MIN	TYP	MAX	UNITS	TEST CONDITIONS	
Operating Voltage Range	V _{DD}	1.0		5.5	V		
V _{DD} Value to Guarantee RESET/ RESET	V _{DDMIN}	1.0			V		
Operating current	I _{DD}		45	60	μA	V _{DD} = 5.5V (no load)	
V _{DD} Trip Point	MCP10X-270	V _{TRIP}	2.55	2.625	2.7	V	
	MCP10X-300		2.85	2.925	3.0		
	MCP10X-315		3.0	3.075	3.15		
	MCP10X-450		4.25	4.375	4.50		
	MCP10X-460		4.35	4.475	4.60		
	MCP10X-475		4.50	4.625	4.75		
	MCP10X-485		4.60	4.725	4.85		
RESET Low Level Output Voltage (MCP100)	MCP100-270	V _{OL}			0.4	V	I _{OL} = 3.2mA, V _{DD} = V _{TRIPMIN}
	MCP100-300						
	MCP100-315						
	MCP100-450				0.6		
	MCP100-460						
MCP100-475							
MCP100-485							
RESET High Level Output Voltage (MCP100)	MCP100-XXX (All V _{TRIP} Points)	V _{OH}	V _{DD} -0.7			V	I _{OH} = 3mA, V _{DD} > V _{TRIPMAX}
RESET Low Level Output Voltage (MCP101)	MCP101-270	V _{OL}			0.4	V	I _{OL} = 3.2mA, V _{DD} > V _{TRIPMAX}
	MCP101-300						
	MCP101-315						
	MCP101-450				0.6		
	MCP101-460						
MCP101-475							
MCP101-485							
RESET High level Output Voltage (MCP101)	MCP101-XXX (All V _{TRIP} Points)	V _{OH}	V _{DD} -0.7			V	I _{OH} = 3mA, V _{DD} = V _{TRIPMIN}
Threshold Hysteresis	V _{HYS}		50		mV		
V _{DD} Detect to RESET/RESET Inactive	t _{RPU}	150	350	700	ms		
V _{DD} Detect to RESET/RESET	t _{RPD}		10		μs	V _{DD} ramped from V _{TRIPMAX} + 250mV down to V _{TRIPMIN} - 250mV	

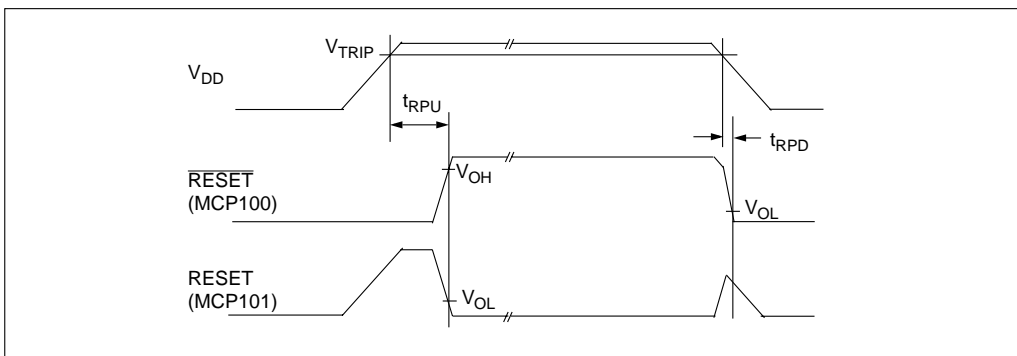

FIGURE 1-1: MCP100/101 Timing Diagram

2.0 APPLICATIONS INFORMATION

2.1 The Need for Supervisory Circuits

For many of today's microcontroller applications, care must be taken to prevent low power conditions that can cause many different system problems. The most common causes are brown-out conditions where the system supply drops below the operating level momentarily, and the second, is when a slowly decaying power supply causes the microcontroller to begin executing instructions without enough voltage to sustain SRAM and producing indeterminate results.

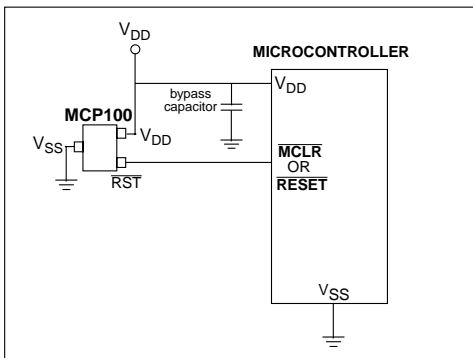

FIGURE 2-1: Typical Application

2.2 Negative Going V_{DD} Transients

Many system designers implementing POR circuits are concerned about the minimum pulse width required to cause a reset. Figure 2-2 shows typical transient duration vs. reset comparator overdrive for which the MCP100/101 will not generate a reset pulse. It shows that the farther below the trip point the transient pulse goes, the duration of the pulse required to cause a reset gets shorter. A 0.1 μF bypass cap mounted as close as possible to the V_{DD} pin provides additional transient immunity.

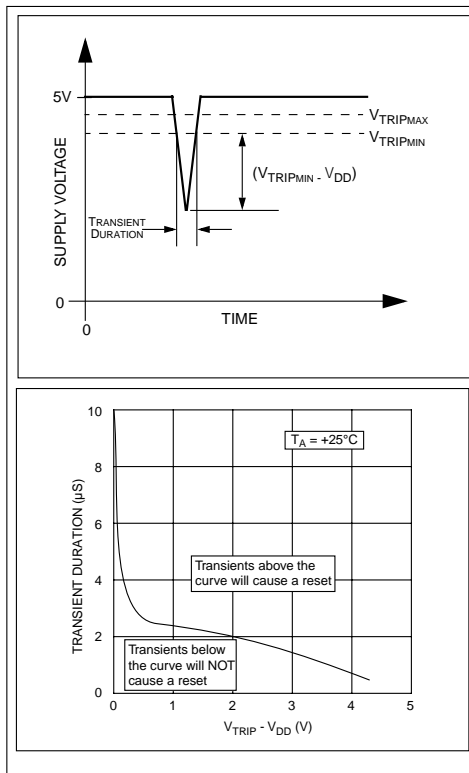

FIGURE 2-2: Typical Transient Response

2.3 Effect of Temperature on Timeout Period (t_{RPU})

The timeout period (t_{RPU}) determines how long the device remains in the reset condition. This is controlled by an internal RC timer and is effected by both V_{DD} and temperature. The graph shown in Figure 2-3 shows typical response for different V_{DD} values and temperatures.

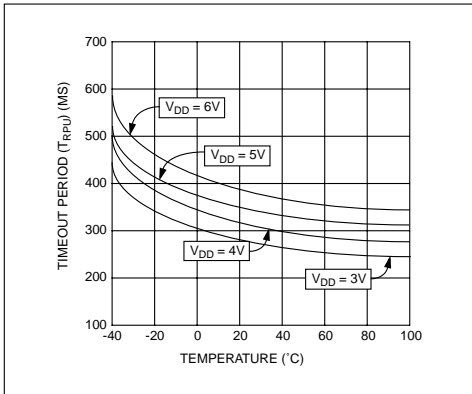

FIGURE 2-3: Typical t_{RPU} vs. Temperature

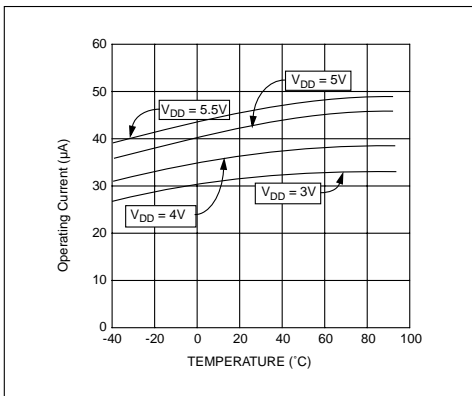

FIGURE 2-4: I_{DD} vs. Temperature

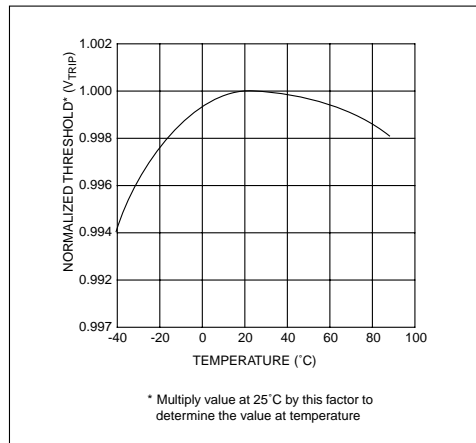

FIGURE 2-5: Normalized V_{TRIP} vs. Temperature

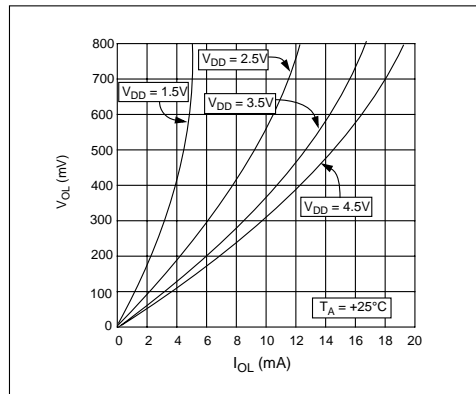

FIGURE 2-6: V_{OL} vs. I_{OL}

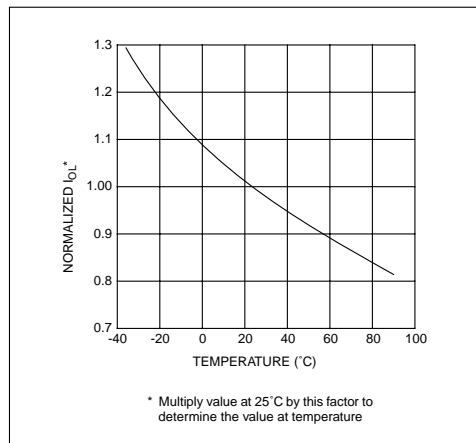

FIGURE 2-7: Normalized I_{OL} vs. Temperature

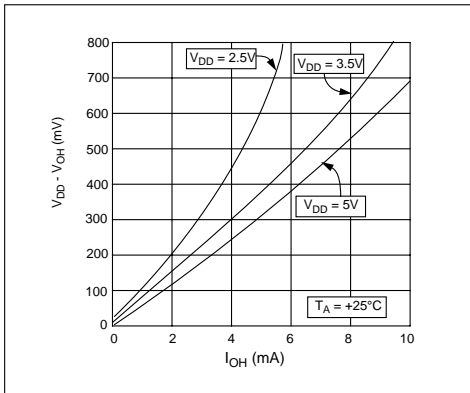

FIGURE 2-8: $V_{DD} - V_{OH}$ vs. I_{OH}

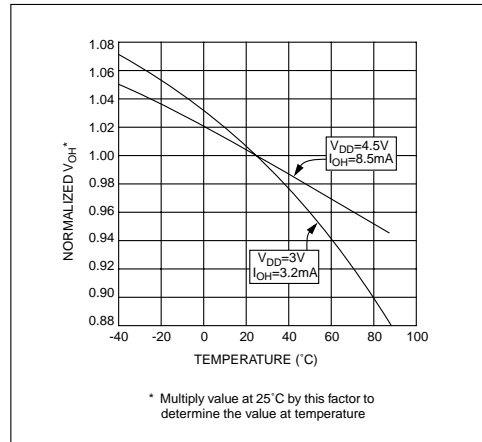

FIGURE 2-9: Normalized V_{OH} vs. Temperature



MCP100/101

NOTES:

MCP100/101 PRODUCT IDENTIFICATION SYSTEM

<p>MCP100/101—xxx b I /pp</p>	<p>Package:</p> <p>Temperature Range</p> <p>Bondout Option (TO-92 only)</p> <p>RESET/RESET V_{TRIP} Voltage</p> <p>Device:</p>	<p>TO = TO-92 (3-lead) [offered in bags only] TT = SOT-23 (3-lead) [offered in tape & reel only]</p> <p>I = -40°C to +85°C (only offered in I)</p> <p>D = D Bond Option (see bond option chart below) H = H Bond Option</p> <p>270 = $2.55 \leq V_{TRIP} \leq 2.70$ 300 = $2.85 \leq V_{TRIP} \leq 3.00$ 315 = $3.00 \leq V_{TRIP} \leq 3.15$ 450 = $4.25 \leq V_{TRIP} \leq 4.50$ 460 = $4.35 \leq V_{TRIP} \leq 4.60$ 475 = $4.50 \leq V_{TRIP} \leq 4.75$ 485 = $4.60 \leq V_{TRIP} \leq 4.85$</p> <p>MCP100 = Supervisor circuit with active low $\overline{\text{RESET}}$ output MCP100T = Supervisor circuit with active low $\overline{\text{RESET}}$ output (tape & reel) MCP101 = Supervisor circuit with active high RESET output MCP101T = Supervisor circuit with active high RESET output (tape & reel)</p>
--------------------------------------	---	--

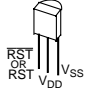
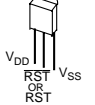
Product Identification Options for MCP100/101

<p>TO-92 with 'D' Bondout</p>  <p>MCP100-xxxD I/TO MCP101-xxxD I/TO</p>	<p>TO-92 with 'H' Bondout</p>  <p>MCP100-xxxH I/TO MCP101-xxxH I/TO</p>	<p>SOT-23-3</p>  <p>MCP100-xxx I/TT MCP101-xxx I/TT</p>
---	---	---

Example of Product Identification:

For the MCP100 (active low $\overline{\text{RESET}}$ pin) with V_{TRIP} range of 2.55V - 2.70V in TO-92 package with 'H' bond option in industrial temp range, the part number would be: MCP100-270H I/TO.

Sales and Support

Data Sheets

Products supported by a preliminary Data Sheet may have an errata sheet describing minor operational differences and recommended workarounds. To determine if an errata sheet exists for a particular device, please contact one of the following:

1. Your local Microchip sales office
2. The Microchip Corporate Literature Center U.S. FAX: (602) 786-7277
3. The Microchip Worldwide Site (www.microchip.com)

Please specify which device, revision of silicon and Data Sheet (include Literature #) you are using.

New Customer Notification System

Register on our web site (www.microchip.com/cn) to receive the most current information on our products.



MICROCHIP

WORLDWIDE SALES AND SERVICE

AMERICAS

Corporate Office

Microchip Technology Inc.
2355 West Chandler Blvd.
Chandler, AZ 85224-6199
Tel: 602-786-7200 Fax: 602-786-7277
Technical Support: 602 786-7627
Web: <http://www.microchip.com>

Atlanta

Microchip Technology Inc.
500 Sugar Mill Road, Suite 200B
Atlanta, GA 30350
Tel: 770-640-0034 Fax: 770-640-0307

Boston

Microchip Technology Inc.
5 Mount Royal Avenue
Marlborough, MA 01752
Tel: 508-480-9990 Fax: 508-480-8575

Chicago

Microchip Technology Inc.
333 Pierce Road, Suite 180
Itasca, IL 60143
Tel: 630-285-0071 Fax: 630-285-0075

Dallas

Microchip Technology Inc.
14651 Dallas Parkway, Suite 816
Dallas, TX 75240-8809
Tel: 972-991-7177 Fax: 972-991-8588

Dayton

Microchip Technology Inc.
Two Prestige Place, Suite 150
Miamisburg, OH 45342
Tel: 937-291-1654 Fax: 937-291-9175

Detroit

Microchip Technology Inc.
42705 Grand River, Suite 201
Novi, MI 48375-1727
Tel: 248-374-1888 Fax: 248-374-2874

Los Angeles

Microchip Technology Inc.
18201 Von Karman, Suite 1090
Irvine, CA 92612
Tel: 714-263-1888 Fax: 714-263-1338

New York

Microchip Technology Inc.
150 Motor Parkway, Suite 202
Hauppauge, NY 11788
Tel: 516-273-5305 Fax: 516-273-5335

AMERICAS (continued)

Toronto

Microchip Technology Inc.
5925 Airport Road, Suite 200
Mississauga, Ontario L4V 1W1, Canada
Tel: 905-405-6279 Fax: 905-405-6253

San Jose

Microchip Technology Inc.
2107 North First Street, Suite 590
San Jose, CA 95131
Tel: 408-436-7950 Fax: 408-436-7955

ASIA/PACIFIC

Hong Kong

Microchip Asia Pacific
RM 3801B, Tower Two
Metroplaza
223 Hing Fong Road
Kwai Fong, N.T., Hong Kong
Tel: 852-2-401-1200 Fax: 852-2-401-3431

India

Microchip Technology Inc.
India Liaison Office
No. 6, Legacy, Convent Road
Bangalore 560 025, India
Tel: 91-80-229-0061 Fax: 91-80-229-0062

Japan

Microchip Technology Intl. Inc.
Benex S-1 6F
3-18-20, Shinyokohama
Kohoku-Ku, Yokohama-shi
Kanagawa 222-0033 Japan
Tel: 81-45-471-6166 Fax: 81-45-471-6122

Korea

Microchip Technology Korea
168-1, Youngbo Bldg. 3 Floor
Samsung-Dong, Kangnam-Ku
Seoul, Korea
Tel: 82-2-554-7200 Fax: 82-2-558-5934

Shanghai

Microchip Technology
RM 406 Shanghai Golden Bridge Bldg.
2077 Yan'an Road West, Hong Qiao District
Shanghai, PRC 200335
Tel: 86-21-6275-5700 Fax: 86 21-6275-5060

ASIA/PACIFIC (continued)

Singapore

Microchip Technology Singapore Pte Ltd.
200 Middle Road
#07-02 Prime Centre
Singapore 188980
Tel: 65-334-8870 Fax: 65-334-8850

Taiwan, R.O.C

Microchip Technology Taiwan
10F-1C 207
Tung Hua North Road
Taipei, Taiwan, ROC
Tel: 886-2-2717-7175 Fax: 886-2-2545-0139

EUROPE

United Kingdom

Arizona Microchip Technology Ltd.
505 Eskdale Road
Winnersh Triangle
Wokingham
Berkshire, England RG41 5TU
Tel: 44-1189-21-5858 Fax: 44-1189-21-5835

France

Arizona Microchip Technology SARL
Zone Industrielle de la Bonde
2 Rue du Buisson aux Fraises
91300 Massy, France
Tel: 33-1-69-53-63-20 Fax: 33-1-69-30-90-79

Germany

Arizona Microchip Technology GmbH
Gustav-Heinemann-Ring 125
D-81739 München, Germany
Tel: 49-89-627-144 0 Fax: 49-89-627-144-44

Italy

Arizona Microchip Technology SRL
Centro Direzionale Colleoni
Palazzo Taurus 1 V. Le Colleoni 1
20041 Agrate Brianza
Milan, Italy
Tel: 39-39-6899939 Fax: 39-39-6899883

9/29/98

All rights reserved. © 1999 Microchip Technology Incorporated. Printed in the USA. 2/99  Printed on recycled paper.

Information contained in this publication regarding device applications and the like is intended for suggestion only and may be superseded by updates. No representation or warranty is given and no liability is assumed by Microchip Technology Incorporated with respect to the accuracy or use of such information, or infringement of patents or other intellectual property rights arising from such use or otherwise. Use of Microchip's products as critical components in life support systems is not authorized except with express written approval by Microchip. No licenses are conveyed, implicitly or otherwise, under any intellectual property rights. The Microchip logo and name are registered trademarks of Microchip Technology Inc. in the U.S.A. and other countries. All rights reserved. All other trademarks mentioned herein are the property of their respective companies.