



SOT23, Micropower, Single-Supply, Rail-to-Rail I/O Op Amps

MAX4162/MAX4163/MAX4164

General Description

The MAX4162/MAX4163/MAX4164 are single/dual/quad, micropower operational amplifiers that combine an exceptional bandwidth to power consumption ratio with true rail-to-rail inputs and outputs. They consume a mere 25µA quiescent current per amplifier, yet achieve 200kHz gain-bandwidth product and are unity-gain stable while driving any capacitive load. The MAX4162/MAX4163/MAX4164 operate from either a single supply (+2.7V to +10V) or dual supplies (±1.35V to ±5V), with an input common-mode voltage range that extends 250mV *beyond* either supply rail. These amplifiers use a proprietary architecture to achieve a very high input common-mode rejection ratio without the mid-swing nonlinearities present in other Rail-to-Rail® op amps. This architecture also maintains high open-loop gain and output swing while driving substantial loads.

The combination of excellent bandwidth/power performance, single-supply operation, and miniature footprint makes these op amps ideal for portable equipment and other low-power, single-supply applications. The single MAX4162 is available in 8-pin SO and space-saving 5-pin SOT23 packages. The MAX4163 is available in an 8-pin µMAX or SO, while the MAX4164 comes in a 14-pin SO.

Applications

- | | |
|----------------------------------|----------------------|
| Battery-Powered Devices | Medical Instruments |
| pH Probes | Ionization Detectors |
| Portable Equipment | Cellular Phones |
| Low-Power, Low-Voltage Equipment | |

Pin Configurations

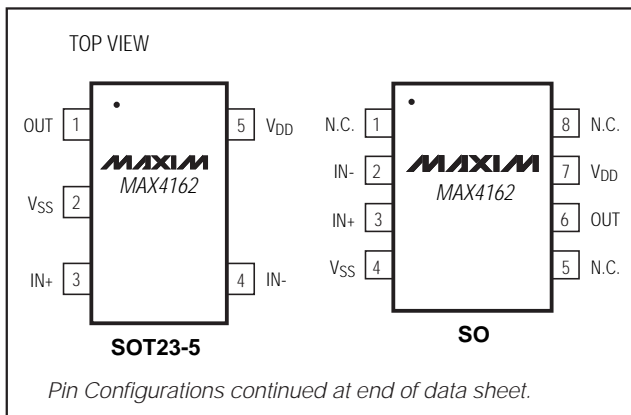

Rail-to-Rail is a registered trademark of Nippon-Motorola, Ltd.

Features

- ◆ 5-Pin SOT23 Package (MAX4162)
- ◆ 1.0pA Typical Input Bias Current
- ◆ Fully Specified Single-Supply Operation at 3V and 5V
- ◆ Input Common-Mode Voltage Range Extends 250mV Beyond Either Supply Rail
- ◆ Rail-to-Rail Output Swing
- ◆ 200kHz Gain-Bandwidth Product
- ◆ 25µA Quiescent Current per Amplifier
- ◆ Excellent CMRR, PSRR, and Gain Linearity
- ◆ No Phase Reversal for Overdriven Inputs
- ◆ Unity-Gain Stable
- ◆ Stable with Any Capacitive Load
- ◆ Internally Short-Circuit Protected to Either Rail

Ordering Information

PART	TEMP. RANGE	PIN-PACKAGE	SOT TOP MARK
MAX4162ESA	-40°C to +85°C	8 SO	—
MAX4162EUK	-40°C to +85°C	5 SOT23-5	AABX
MAX4163ESA	-40°C to +85°C	8 SO	—
MAX4163EUA	-40°C to +85°C	8 µMAX	—
MAX4164ESD	-40°C to +85°C	14 SO	—

Typical Application Circuit

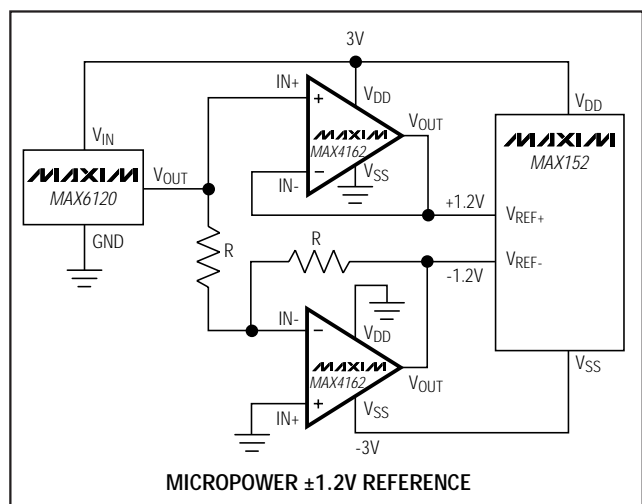

SOT23, Micropower, Single-Supply, Rail-to-Rail I/O Op Amps

ABSOLUTE MAXIMUM RATINGS

Supply Voltage (V_{DD} to V_{SS}).....	+11V	8-Pin μ MAX (derate 4.1mW/°C above +70°C)	330mW
IN+, IN-, OUT Voltage	($V_{DD} + 0.3V$) to ($V_{SS} - 0.3V$)	14-Pin SO (derate 8.00mW/°C above +70°C).....	640mW
Short-Circuit Duration (to either rail).....	Continuous	Operating Temperature Range	-40°C to +85°C
Continuous Power Dissipation ($T_A = +70^\circ\text{C}$)		Storage Temperature Range	-65°C to +150°C
5-Pin SOT23 (derate 7.1mW/°C above +70°C).....	571mW	Lead Temperature (soldering, 10sec)	+300°C
8-Pin SO (derate 5.88mW/°C above +70°C).....	471mW		

Stresses beyond those listed under "Absolute Maximum Ratings" may cause permanent damage to the device. These are stress ratings only, and functional operation of the device at these or any other conditions beyond those indicated in the operational sections of the specifications is not implied. Exposure to absolute maximum rating conditions for extended periods may affect device reliability.

ELECTRICAL CHARACTERISTICS: +3V Operation

($V_{DD} = +3V$, $V_{SS} = 0V$, $V_{CM} = V_{DD} / 2$, $V_{OUT} = V_{DD} / 2$, R_L tied to $V_{DD} / 2$, $T_A = -40^\circ\text{C}$ to $+85^\circ\text{C}$, unless otherwise noted. Typical values are at $T_A = +25^\circ\text{C}$.)

PARAMETER	CONDITIONS		MIN	TYP	MAX	UNITS
Operating Voltage Range	Inferred from PSRR test		2.7		10.0	V
Supply Current (per amplifier)				25	40	μA
Input Bias Current (Note 1)				1.0	100	pA
Input Offset Voltage	MAX4162	$T_A = +25^\circ\text{C}$		± 0.5	± 3	mV
		$T_A = -40^\circ\text{C}$ to $+85^\circ\text{C}$			± 4	
	MAX4163	$T_A = +25^\circ\text{C}$		± 0.5	± 4	
		$T_A = -40^\circ\text{C}$ to $+85^\circ\text{C}$			± 5	
	MAX4164	$T_A = +25^\circ\text{C}$		± 0.5	± 5	
		$T_A = -40^\circ\text{C}$ to $+85^\circ\text{C}$			± 6	
Input Offset Voltage Tempco				2		$\mu\text{V}/^\circ\text{C}$
Differential Input Resistance				>10		$\text{T}\Omega$
Input Common-Mode Voltage Range	Inferred from CMRR test		$V_{SS} - 0.25$		$V_{DD} + 0.25$	V
Common-Mode Rejection Ratio	$V_{CM} = (V_{SS} - 0.25V)$ to $(V_{DD} + 0.25V)$		70	100		dB
Large-Signal Voltage Gain	$R_L = 10\text{k}\Omega$		85	120		dB
Output Voltage Swing	$R_L = 10\text{k}\Omega$	$V_{DD} - V_{OH}$		30	180	mV
		$V_{OL} - V_{SS}$		30	180	
	$R_L = 100\text{k}\Omega$	$V_{DD} - V_{OH}$		3	25	
		$V_{OL} - V_{SS}$		3	25	
Output Short-Circuit Current	To either supply rail			15		mA
Closed-Loop Output Resistance	$A_V = +1V/V$			0.1		Ω
Power-Supply Rejection Ratio	$V_{DD} = 2.7V$ to $10V$		80	110		dB
Gain-Bandwidth Product				200		kHz
Phase Margin				60		degrees
Gain Margin				12		dB
Total Harmonic Distortion	$f = 1\text{kHz}$, $V_{OUT} = 2V_{p-p}$, $R_L = 100\text{k}\Omega$, $A_V = +1V/V$			0.02		%
Slew Rate				115		V/ms
Settling Time to 0.1%	$V_{OUT} = 1V$ to $2V$ step			50		μs
Turn-On Time	$V_{DD} = 0V$ to $3V$ step, $V_{IN} = V_{DD} / 2$, $A_V = +1V/V$			20		μs

SOT23, Micropower, Single-Supply, Rail-to-Rail I/O Op Amps

MAX4162/MAX4163/MAX4164

ELECTRICAL CHARACTERISTICS: +3V Operation (continued)

($V_{DD} = +3V$, $V_{SS} = 0V$, $V_{CM} = V_{DD} / 2$, $V_{OUT} = V_{DD} / 2$, R_L tied to $V_{DD} / 2$, $T_A = -40^{\circ}C$ to $+85^{\circ}C$, unless otherwise noted. Typical values are at $T_A = +25^{\circ}C$.)

PARAMETER	CONDITIONS	MIN	TYP	MAX	UNITS
Input Noise Voltage Density	$f = 1kHz$		80		nV/\sqrt{Hz}
Differential Input Capacitance			0.7		pF
Input Common-Mode Capacitance			1.5		pF
Internal Charge-Pump Frequency			700		kHz
Charge-Pump Output Feedthrough			100		$\mu Vp-p$

ELECTRICAL CHARACTERISTICS: +5V Operation

($V_{DD} = +5V$, $V_{SS} = 0V$, $V_{CM} = V_{DD} / 2$, $V_{OUT} = V_{DD} / 2$, R_L tied to $V_{DD} / 2$, $T_A = -40^{\circ}C$ to $+85^{\circ}C$, unless otherwise noted. Typical values are at $T_A = +25^{\circ}C$.)

PARAMETER	CONDITIONS	MIN	TYP	MAX	UNITS
Operating Voltage Range	Inferred from PSRR test	2.7		10.0	V
Supply Current (per amplifier)			27	45	μA
Input Bias Current (Note 1)			1.0	100	pA
Input Offset Voltage	MAX4162	$T_A = +25^{\circ}C$	± 0.5	± 3	mV
		$T_A = -40^{\circ}C$ to $+85^{\circ}C$		± 4	
	MAX4163	$T_A = +25^{\circ}C$	± 0.5	± 4	
		$T_A = -40^{\circ}C$ to $+85^{\circ}C$		± 5	
	MAX4164	$T_A = +25^{\circ}C$	± 0.5	± 5	
		$T_A = -40^{\circ}C$ to $+85^{\circ}C$		± 6	
Input Offset Voltage Tempco			2		$\mu V/^{\circ}C$
Differential Input Resistance			>10		$T\Omega$
Input Common-Mode Voltage Range	Inferred from CMRR test	$V_{SS} - 0.25$		$V_{DD} + 0.25$	V
Common-Mode Rejection Ratio	$V_{CM} = (V_{SS} - 0.25V)$ to $(V_{DD} + 0.25V)$	70	100		dB
Large-Signal Voltage Gain		85	120		dB
Output Voltage Swing	$R_L = 10k\Omega$	$V_{DD} - V_{OH}$	50	300	mV
		$V_{OL} - V_{SS}$	50	300	
	$R_L = 100k\Omega$	$V_{DD} - V_{OH}$	5	40	
		$V_{OL} - V_{SS}$	5	40	
Output Short-Circuit Current	To either supply rail		15		mA
Closed-Loop Output Resistance	$A_V = +1V/V$		0.1		Ω
Power-Supply Rejection Ratio	$V_{DD} = 4.5V$ to $10V$	80	110		dB
Gain-Bandwidth Product			200		kHz
Phase Margin			60		degrees
Gain Margin			12		dB

SOT23, Micropower, Single-Supply, Rail-to-Rail I/O Op Amps

ELECTRICAL CHARACTERISTICS: +5V Operation (continued)

($V_{DD} = +5V$, $V_{SS} = 0V$, $V_{CM} = V_{DD} / 2$, $V_{OUT} = V_{DD} / 2$, R_L tied to $V_{DD} / 2$, $T_A = -40^{\circ}C$ to $+85^{\circ}C$, unless otherwise noted. Typical values are at $T_A = +25^{\circ}C$.)

PARAMETER	CONDITIONS	MIN	TYP	MAX	UNITS
Total Harmonic Distortion	$f = 1kHz$, $V_{OUT} = 2V_{p-p}$, $R_L = 100k\Omega$, $A_V = +1V/V$		0.02		%
Slew Rate			115		V/ms
Settling Time to 0.1%	$V_{OUT} = 1V$ to 4V step		70		μs
Turn-On Time	$V_{DD} = 0V$ to 5V step, $V_{IN} = V_{DD} / 2$, $A_V = +1V/V$		40		μs
Input Noise Voltage Density	$f = 1kHz$		80		nV/\sqrt{Hz}
Differential Input Capacitance			0.7		pF
Input Common-Mode Capacitance			1.5		pF
Internal Charge-Pump Frequency			700		MHz
Charge-Pump Output Feedthrough			100		μV_{p-p}

Note 1: Input bias current guaranteed by design, not production tested.

Note 2: The MAX4162EUK specifications are 100% tested at $T_A = +25^{\circ}C$. Limits over the extended temperature range are guaranteed by design, not production tested.

Typical Operating Characteristics

($V_{DD} = +5V$, $V_{SS} = 0V$, $V_{CM} = V_{DD} / 2$, $T_A = +25^{\circ}C$, unless otherwise noted.)

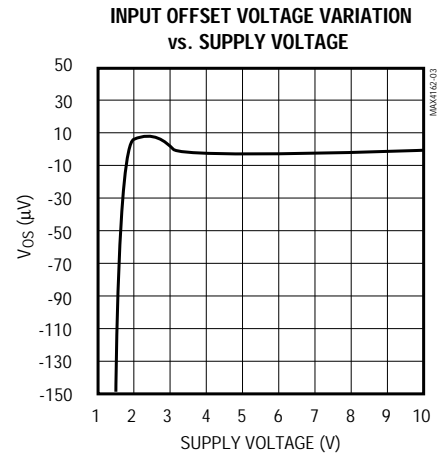
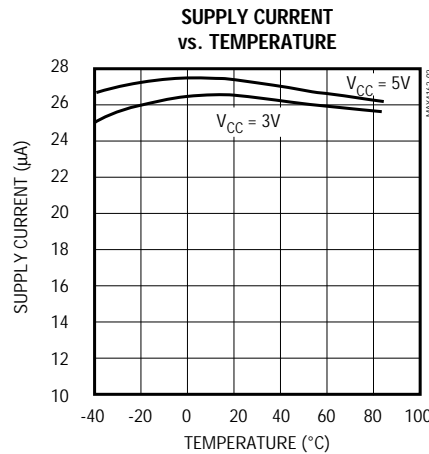
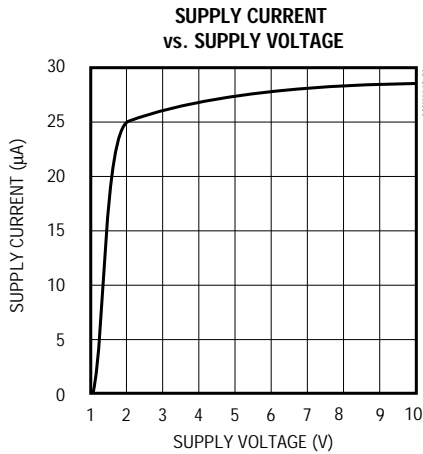

SOT23, Micropower, Single-Supply, Rail-to-Rail I/O Op Amps

MAX4162/MAX4163/MAX4164

Typical Operating Characteristics (continued)

($V_{DD} = +5V$, $V_{SS} = 0V$, $V_{CM} = V_{DD}/2$, $T_A = +25^\circ C$, unless otherwise noted.)

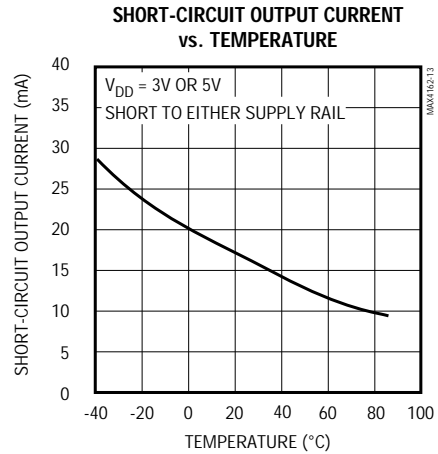
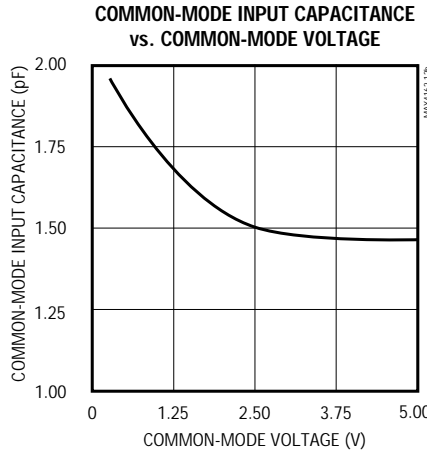
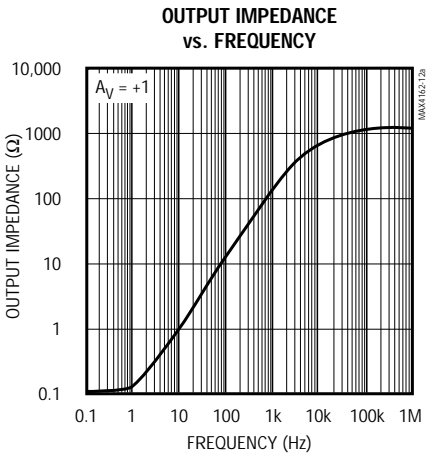
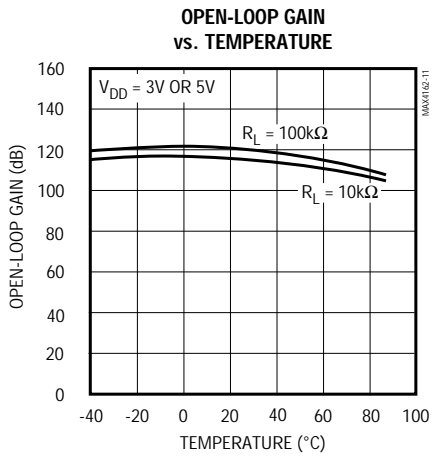
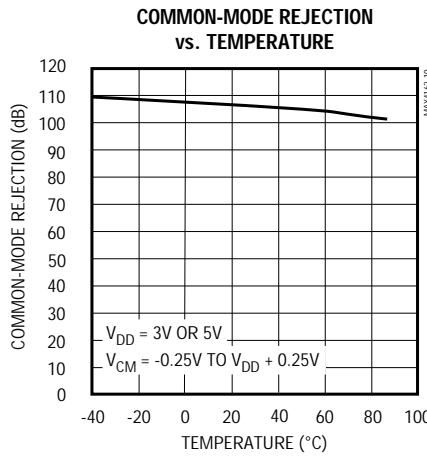
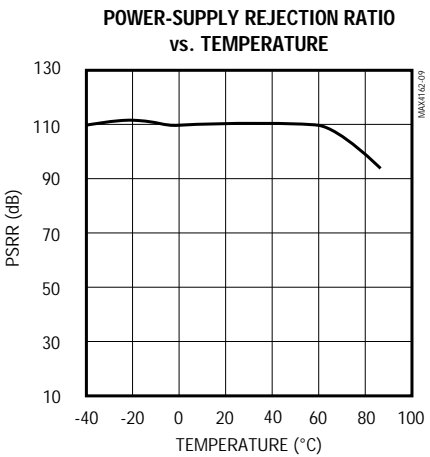
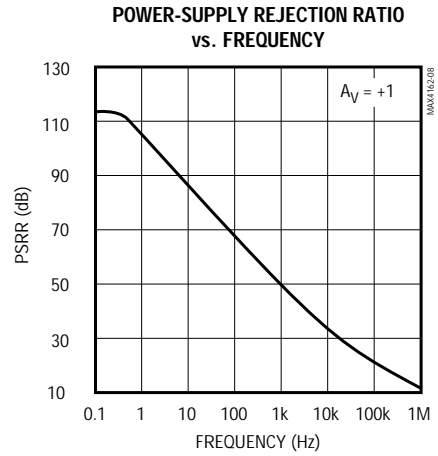
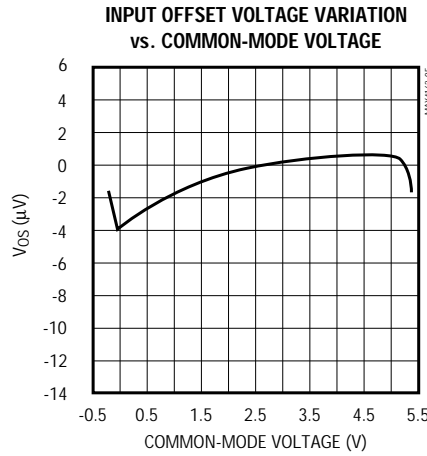
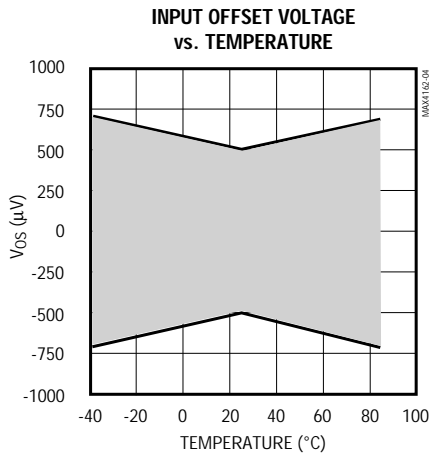

SOT23, Micropower, Single-Supply, Rail-to-Rail I/O Op Amps

Typical Operating Characteristics (continued)

($V_{DD} = +5V$, $V_{SS} = 0V$, $V_{CM} = V_{DD} / 2$, $T_A = +25^\circ C$, unless otherwise noted.)

MAXIMUM OUTPUT VOLTAGE vs. LOAD CURRENT

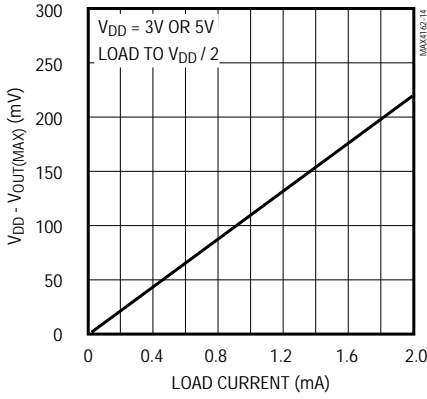

MINIMUM OUTPUT VOLTAGE vs. LOAD CURRENT

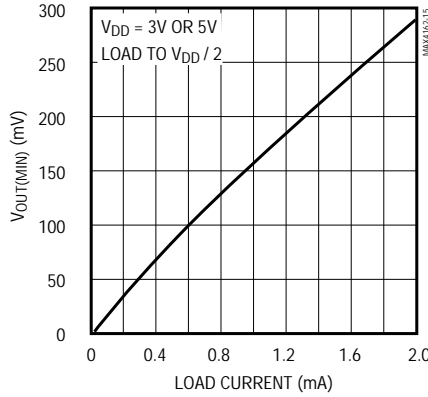

MAXIMUM OUTPUT VOLTAGE vs. TEMPERATURE ($V_{DD} = 5V$)

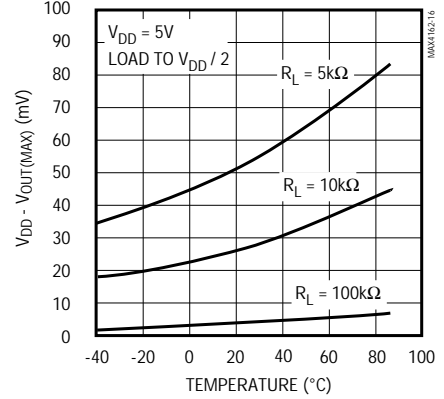

MINIMUM OUTPUT VOLTAGE vs. TEMPERATURE ($V_{DD} = 5V$)

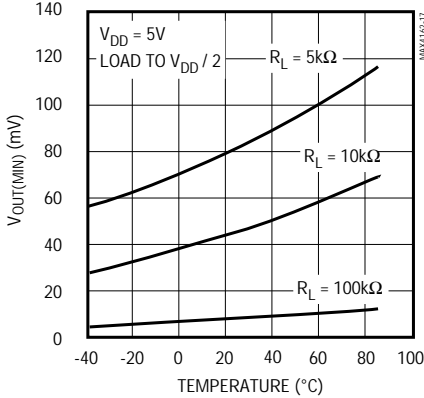

MAXIMUM OUTPUT VOLTAGE vs. TEMPERATURE ($V_{DD} = 3V$)

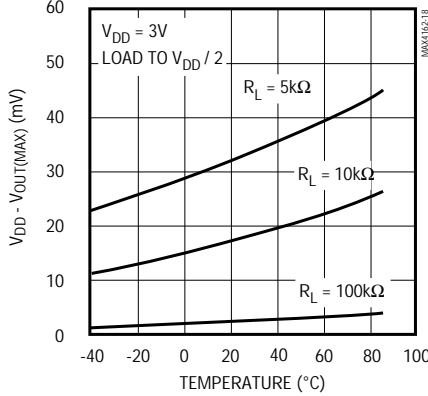

MINIMUM OUTPUT VOLTAGE vs. TEMPERATURE ($V_{DD} = 3V$)

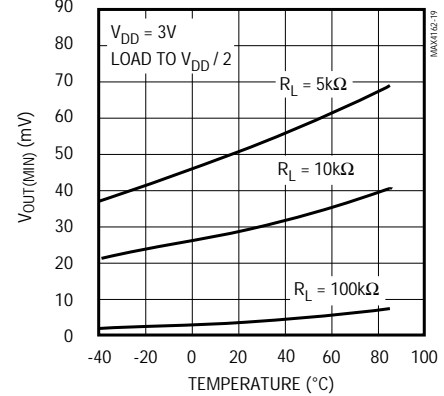

NOISE VOLTAGE DENSITY vs. COMMON-MODE VOLTAGE

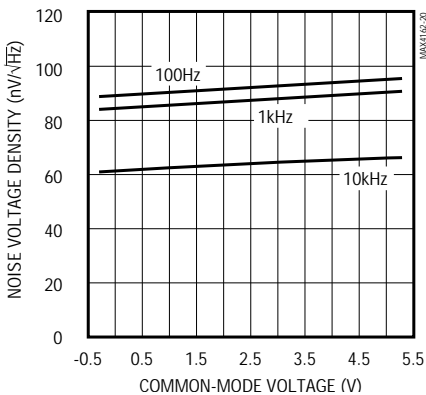

NOISE VOLTAGE DENSITY vs. FREQUENCY

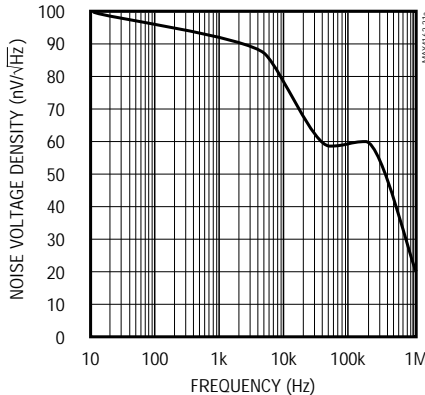

TOTAL HARMONIC DISTORTION PLUS NOISE vs. FREQUENCY

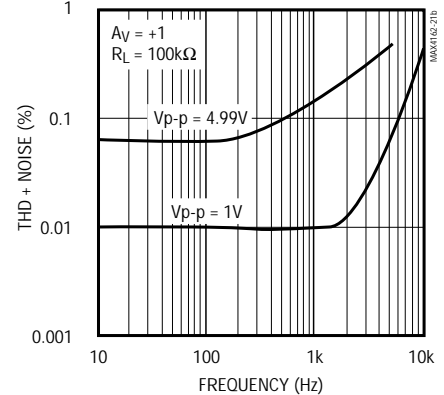

SOT23, Micropower, Single-Supply, Rail-to-Rail I/O Op Amps

MAX4162/MAX4163/MAX4164

Typical Operating Characteristics (continued)

($V_{DD} = +5V$, $V_{SS} = 0V$, $V_{CM} = V_{DD} / 2$, $T_A = +25^\circ C$, unless otherwise noted.)

TOTAL HARMONIC DISTORTION PLUS NOISE vs. OUTPUT VOLTAGE SWING

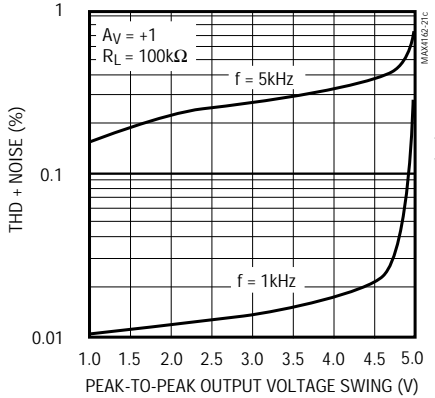

GAIN AND PHASE vs. FREQUENCY ($C_L = 0\text{pF}$)

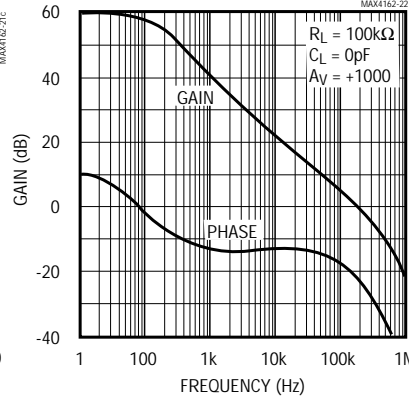

GAIN AND PHASE vs. FREQUENCY ($C_L = 500\text{pF}$)

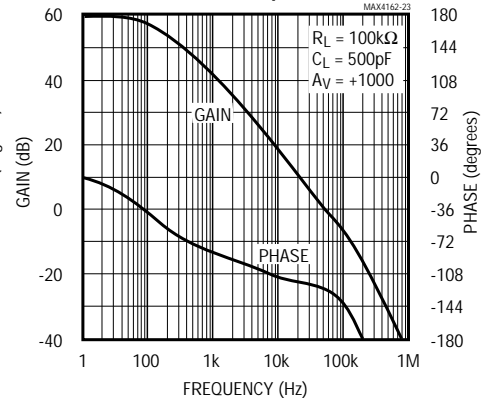

GAIN AND PHASE vs. FREQUENCY ($C_L = 0.01\mu\text{F}$)

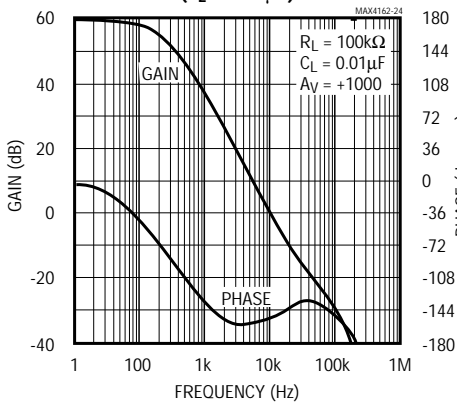

NONINVERTING SMALL-SIGNAL PULSE RESPONSE ($V_{DD} = 3V$, $C_L = 0\text{pF}$)

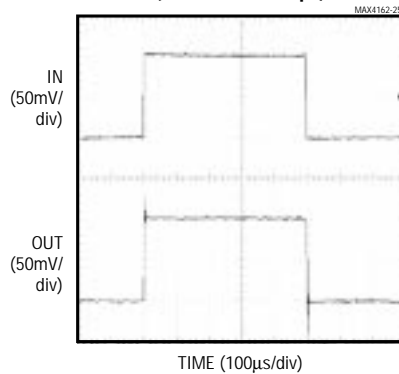

$V_{DD} = 3V$, $V_{IN} = 100\text{mV}$, $R_L = 100\text{k}\Omega$ to $V_{DD} / 2$, $C_L = 0\text{pF}$

NONINVERTING SMALL-SIGNAL PULSE RESPONSE ($V_{DD} = 3V$, $C_L = 1500\text{pF}$)

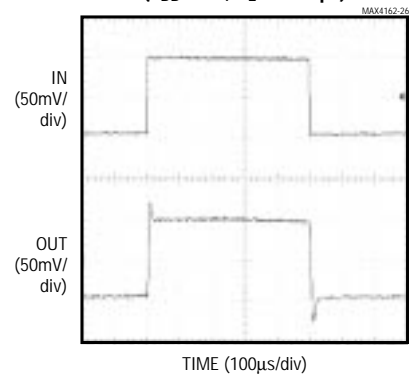

$V_{DD} = 3V$, $V_{IN} = 100\text{mV}$, $R_L = 100\text{k}\Omega$ to $V_{DD} / 2$, $C_L = 1500\text{pF}$

SOT23, Micropower, Single-Supply, Rail-to-Rail I/O Op Amps

Typical Operating Characteristics (continued)

($V_{DD} = +5V$, $V_{SS} = 0V$, $V_{CM} = V_{DD} / 2$, $T_A = +25^\circ C$, unless otherwise noted.)

**NONINVERTING
SMALL-SIGNAL PULSE RESPONSE
($V_{DD} = 5V$, $C_L = 0pF$)**

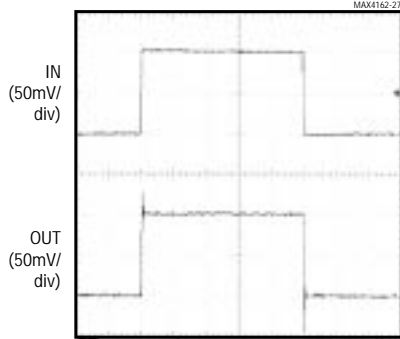

TIME (100µs/div)
 $V_{DD} = 5V$, $V_{IN} = 100mV$, $R_L = 100k\Omega$ to $V_{DD} / 2$,
 $C_L = 0pF$

**NONINVERTING
SMALL-SIGNAL PULSE RESPONSE
($V_{DD} = 5V$, $C_L = 1500pF$)**

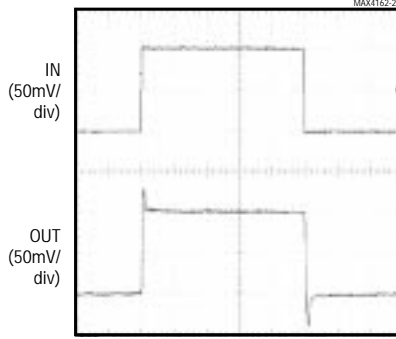

TIME (100µs)
 $V_{DD} = 5V$, $V_{IN} = 100mV$, $R_L = 100k\Omega$ to $V_{DD} / 2$,
 $C_L = 1500pF$

**NONINVERTING
LARGE-SIGNAL PULSE RESPONSE
($V_{DD} = 3V$, $C_L = 0pF$)**

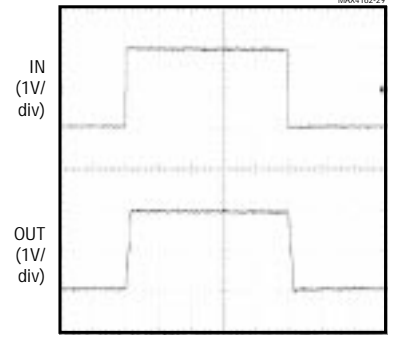

TIME (100µs/div)
 $V_{DD} = 3V$, $V_{IN} = 2V$, $R_L = 100k\Omega$ to $V_{DD} / 2$,
 $C_L = 0pF$

**NONINVERTING
LARGE-SIGNAL PULSE RESPONSE
($V_{DD} = 3V$, $C_L = 1500pF$)**

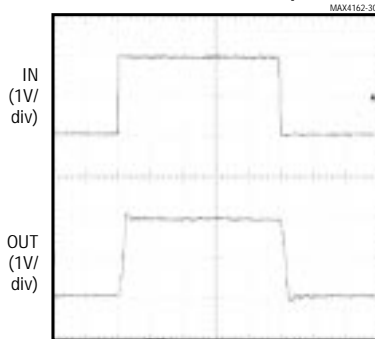

TIME (100µs/div)
 $V_{DD} = 3V$, $V_{IN} = 2V$, $R_L = 100k\Omega$ to $V_{DD} / 2$,
 $C_L = 1500pF$

**NONINVERTING
LARGE-SIGNAL PULSE RESPONSE
($V_{DD} = 5V$, $C_L = 0pF$)**

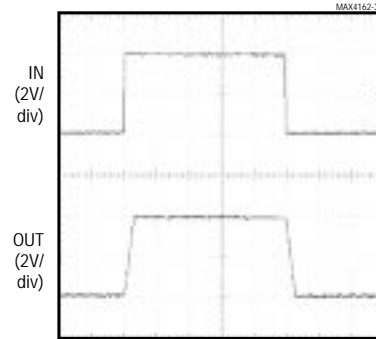

TIME (100µs/div)
 $V_{DD} = 5V$, $V_{IN} = 4V$, $R_L = 100k\Omega$ to $V_{DD} / 2$,
 $C_L = 0pF$

SOT23, Micropower, Single-Supply, Rail-to-Rail I/O Op Amps

Typical Operating Characteristics (continued)

($V_{DD} = +5V$, $V_{SS} = 0V$, $V_{CM} = V_{DD} / 2$, $T_A = +25^\circ C$, unless otherwise noted.)

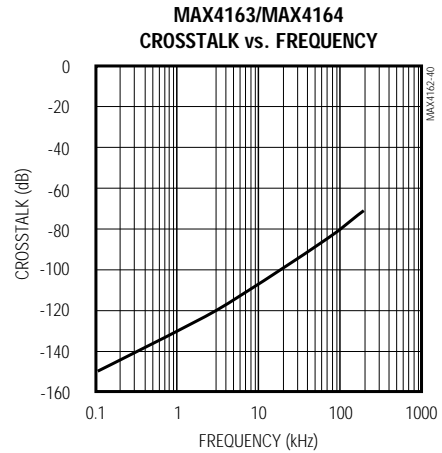
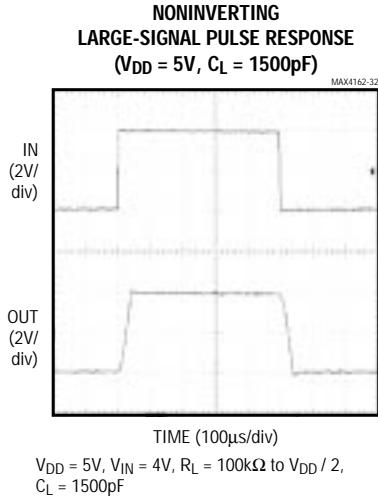

Pin Description

PIN				NAME	FUNCTION
MAX4162		MAX4163 SO/ μ MAX	MAX4164 SO		
SO	SOT23-5				
1, 5, 8	—	—	—	N.C.	No Connection. Not internally connected.
2	4	—	—	IN-	Amplifier Inverting Input
3	3	—	—	IN+	Amplifier Noninverting Input
4	2	4	11	V_{SS}	Negative Power Supply
6	1	—	—	OUT	Amplifier Output
7	5	8	4	V_{DD}	Positive Power Supply
—	—	1	1	OUTA	Amplifier A Output
—	—	2	2	INA-	Amplifier A Inverting Input
—	—	3	3	INA+	Amplifier A Noninverting Input
—	—	5	5	INB+	Amplifier B Noninverting Input
—	—	6	6	INB-	Amplifier B Inverting Input
—	—	7	7	OUTB	Amplifier B Output
—	—	—	8	OUTC	Amplifier C Output
—	—	—	9	INC-	Amplifier C Inverting Input
—	—	—	10	INC+	Amplifier C Noninverting Input
—	—	—	12	IND+	Amplifier D Noninverting Input
—	—	—	13	IND-	Amplifier D Inverting Input
—	—	—	14	OUTD	Amplifier D Output

SOT23, Micropower, Single-Supply, Rail-to-Rail I/O Op Amps

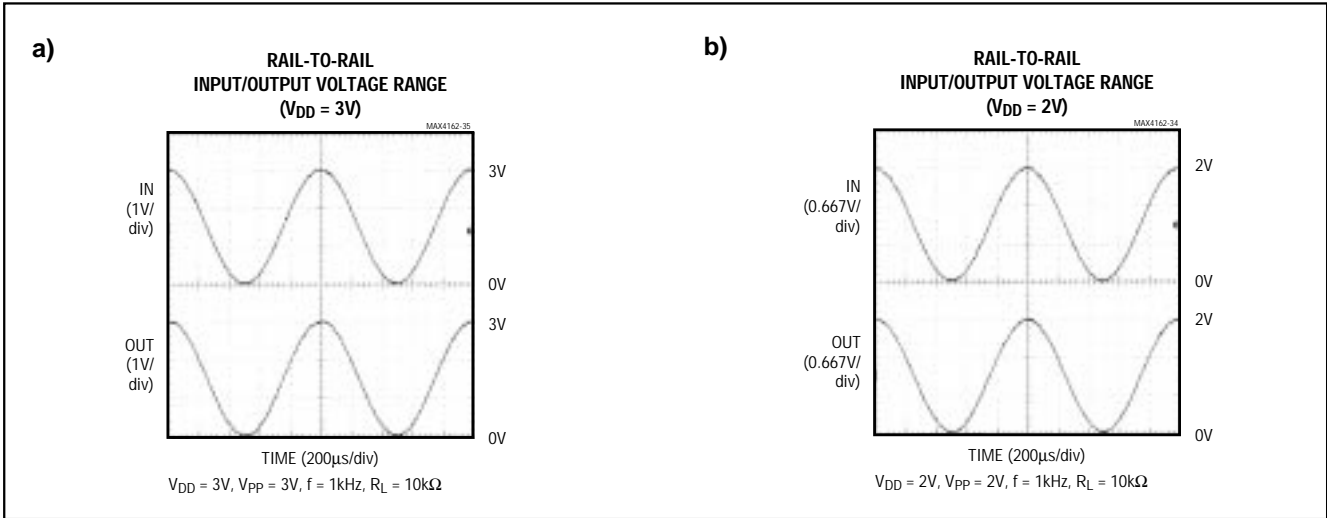

Figure 1. Rail-to-Rail I/O: a) $V_{DD} = 3V$; b) $V_{DD} = 2V$

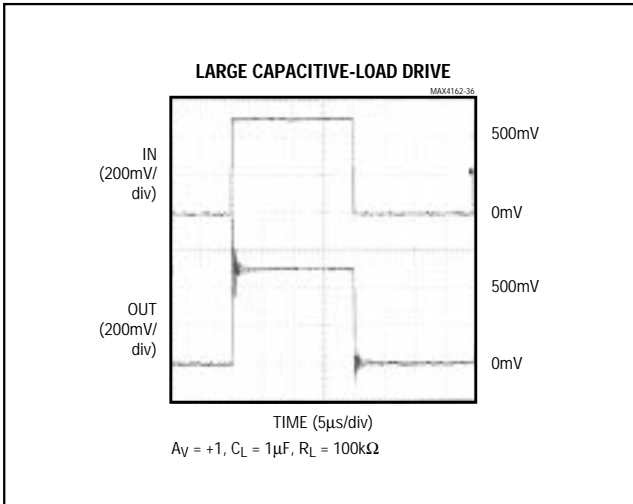

Figure 2. Large Capacitive-Load Drive

Applications Information

Rail-to-Rail Inputs and Outputs

The MAX4162/MAX4163/MAX4164 input common-mode range extends 250mV *beyond* each of the supply rails, providing a substantial increase in dynamic range over other op amps (even many of those referred to as rail-to-rail). Although the minimum operating voltage is specified at 2.7V, the devices typically provide full rail-to-rail operation below 2.0V (Figure 1). These amplifiers do not suffer from midswing common-mode-rejection degrada-

tion or crossover nonlinearity often encountered in other rail-to-rail op amps. Extremely low, 1.0pA input bias current makes these devices ideal for applications such as pH probes, electrometers, and ionization detectors. They are also protected against phase reversal (inferred from CMRR test) and latchup for input signals extending beyond the supply rails. The output stage achieves a lower output impedance than traditional rail-to-rail output stages, providing an output voltage range that typically swings within 150mV of the supply rails for 1mA loads. This architecture also maintains high open-loop gain and output swing while driving substantial loads.

Output Loading and Stability

These devices drive 1mA loads to within 150mV of the supply rails while consuming only 25µA of quiescent current. Internal compensation allows these amplifiers to remain unity-gain stable while driving any capacitive load (Figure 2).

Internal Charge Pump

An internal charge pump provides two internal supplies typically 2V beyond each rail. These internal rails allow the MAX4162/MAX4163/MAX4164 to achieve true rail-to-rail inputs and outputs, while providing excellent common-mode rejection, power-supply rejection ratios, and gain linearity.

These charge pumps require no external components, and in most applications are entirely transparent to the user. Two characteristics may be visible to the user, depending on the application:

SOT23, Micropower, Single-Supply, Rail-to-Rail I/O Op Amps

MAX4162/MAX4163/MAX4164

- 1) The on-board charge pumps generate a small amount of 700kHz switching noise at the op amp's output. The amplitude of this noise is typically 100µVp-p. The noise is **not** referred to the input, and is independent of amplifier gain. The charge-pump switching frequency is well beyond the amplifier's 200kHz bandwidth, and is therefore unnoticeable in most applications.
- 2) The charge pumps typically require up to 20µs on power-up to fully energize the internal supply rails (Figure 3).

Power Supplies and Layout

The MAX4162/MAX4163/MAX4164 are guaranteed to operate from a single +2.7V to +10.0V power supply, but full rail-to-rail operation typically extends below 2V. For single-supply operation, bypass the power supply with a 1µF capacitor in parallel with a 0.1µF ceramic capacitor. If operating from dual supplies, bypass each supply to ground.

Good layout improves performance by decreasing the amount of stray capacitance at the op amp's inputs and output. To decrease stray capacitance, minimize both trace and external component lead lengths, and place external components close to the op amp's pins.

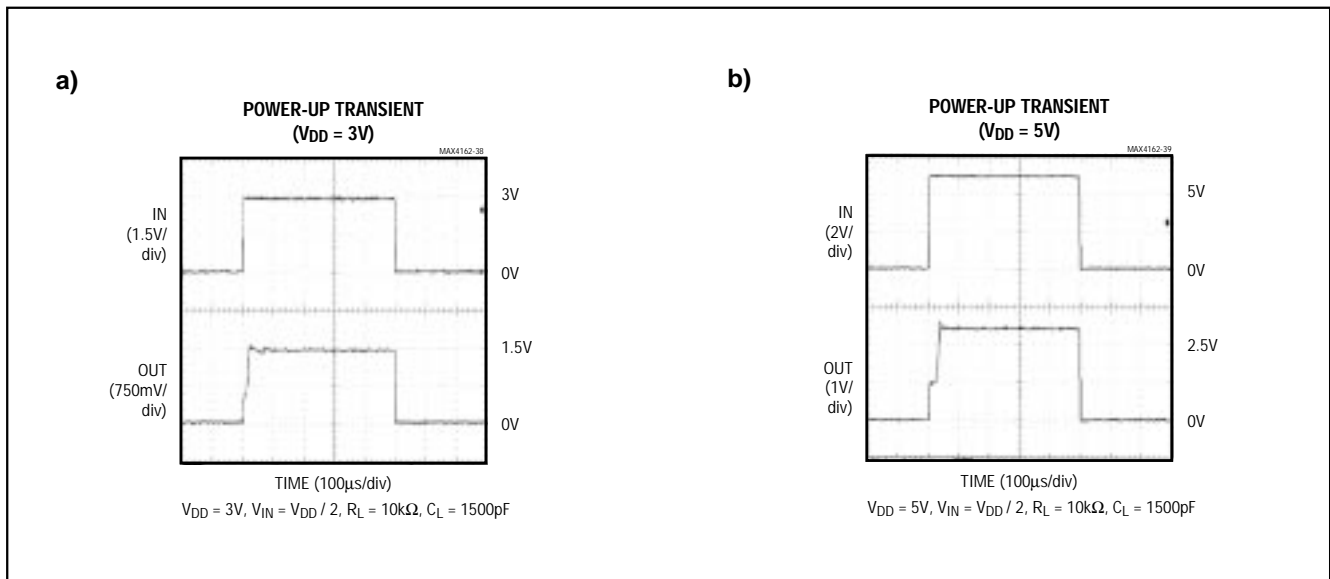
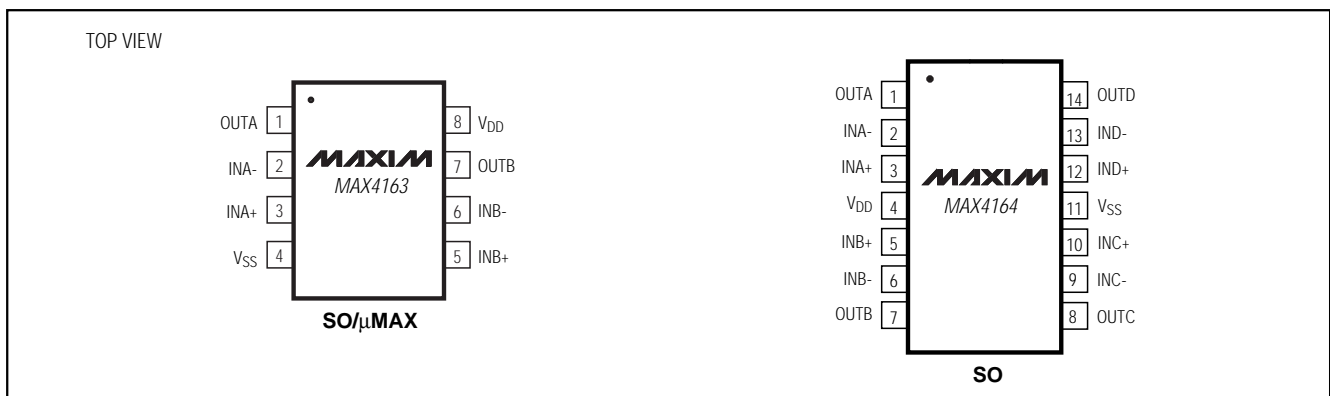

Figure 3. Power-Up Transient: a) $V_{DD} = 3V$; b) $V_{DD} = 5V$

Pin Configurations (continued)



SOT23, Micropower, Single-Supply, Rail-to-Rail I/O Op Amps

Chip Information

MAX4162 TRANSISTOR COUNT: 291

MAX4163 TRANSISTOR COUNT: 496

MAX4164 TRANSISTOR COUNT: 992

Tape-and-Reel Information

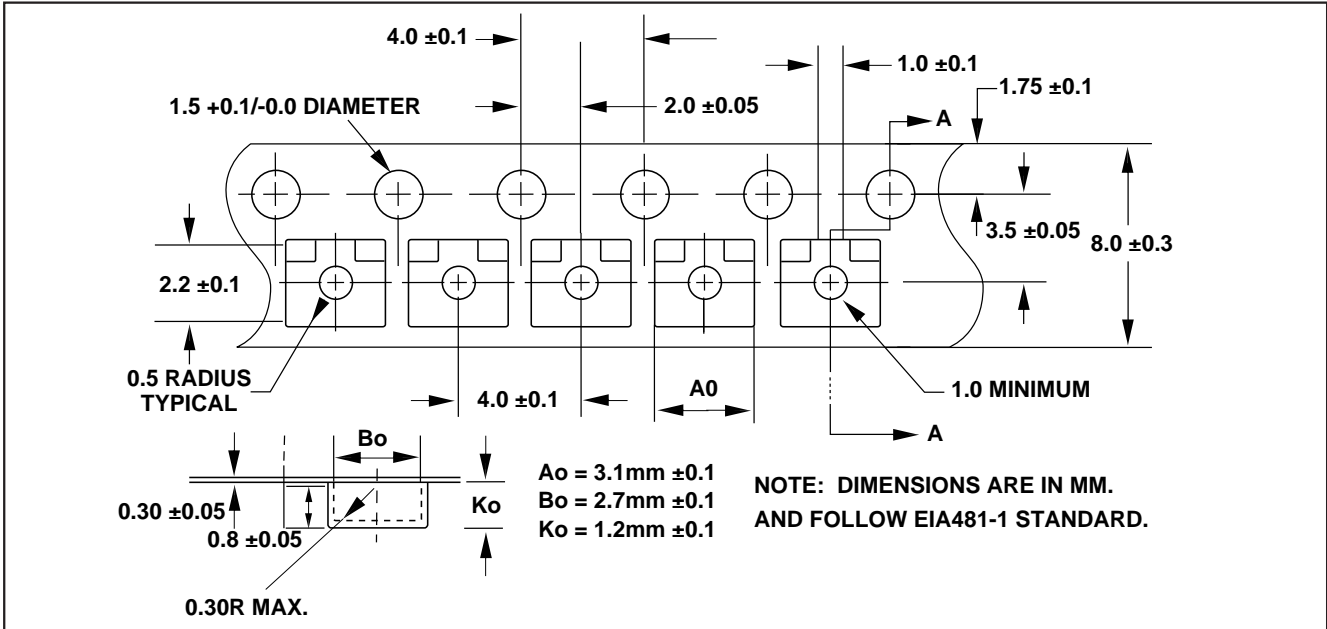

Package Information

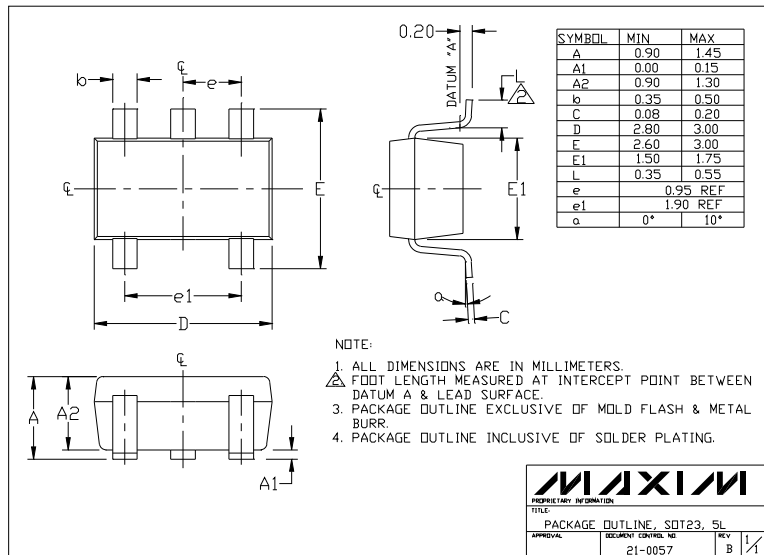

Maxim cannot assume responsibility for use of any circuitry other than circuitry entirely embodied in a Maxim product. No circuit patent licenses are implied. Maxim reserves the right to change the circuitry and specifications without notice at any time.

12 Maxim Integrated Products, 120 San Gabriel Drive, Sunnyvale, CA 94086 (408) 737-7600