

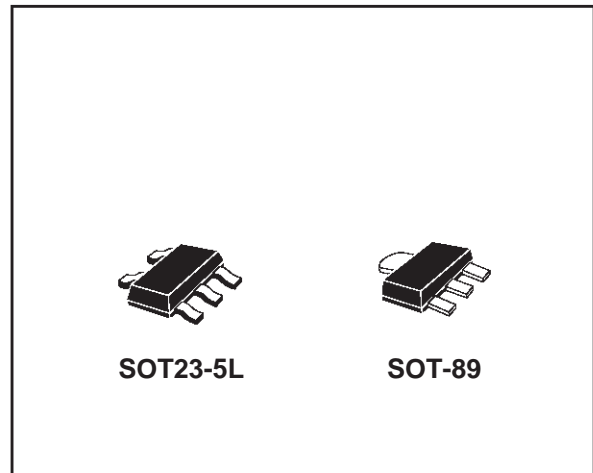

LD2981 SERIES

VERY LOW DROP VOLTAGE REGULATORS WITH INHIBIT

- ULTRA LOW DROPOUT VOLTAGE
(0.2V AT 100mA LOAD, 7mV AT 1mA LOAD)
- VERY LOW QUIESCENT CURRENT
(MAX 1 μ A WHEN IS IN SHUTDOWN MODE)
- OUTPUT CURRENT UP TO 100 mA
- LOGIC-CONTROLLED ELECTRONIC SHUTDOWN
- OUTPUT VOLTAGES OF 2.85; 3.0; 3.2; 3.3; 3.8; 4.85; 5.0V
- INTERNAL CURRENT AND THERMAL LIMIT
- AVAILABLE IN $\pm 0.75\%$ TOLLERANCE (AT 25 $^{\circ}$ C, A VERSION)
- OUTPUT LOW NOISE VOLTAGE 160 μ Vrms
- ONLY 4.7 μ F FOR STABILITY
- TEMPERATURE RANGE: -40 TO 125 $^{\circ}$ C
- SMALLEST PACKAGE SOT23-5L AND SOT-89
- FAST DYNAMIC RESPONCE TO LINE AND LOAD CHANGES



In sleep mode quiescent current is less than 1 μ A when INHIBIT pin is pulled low. Shutdown Logic Control function is available on pin n.3 (TTL compatible). This means that when the device is used as local regulator, it is possible to put a part of the board in standby, decreasing the total power consumption. Typical application are in cellular phone, palmtop/laptop computer, personal digital assistant (PDA), personal stereo, camcorder and camera.

DESCRIPTION

The LD2981 series are 100mA fixed-output voltage regulator. The ultra drop-voltage and the ultra low quiescent current make them particularly suitable for low noise, low power applications and in battery powered systems.

SCHEMATIC DIAGRAM

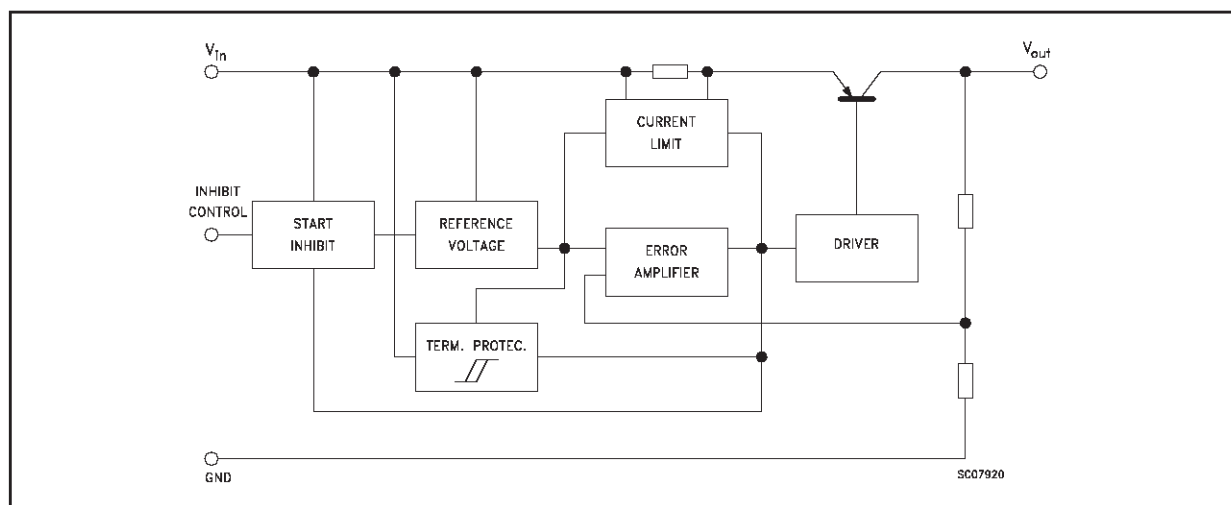

ABSOLUTE MAXIMUM RATING

Symbol	Parameter	Value	Unit
V_{IN}	DC Input Voltage	16	V
V_{INH}	INHBIT Input Voltage	16	V
I_o	Output Current	Internally limited	mA
P_{tot}	Power Dissipation	Internally limited	mW
T_{stg}	Storage Temperature Range	- 55 to 150	°C
T_{op}	Operating Junction Temperature Range	- 40 to 125	°C

THERMAL DATA

Symbol	Parameter	SOT-89	SOT23-5L	Unit
$R_{thj-case}$	Thermal Resistance Junction-case	15	81	°C/W

CONNECTION DIAGRAM (top view)

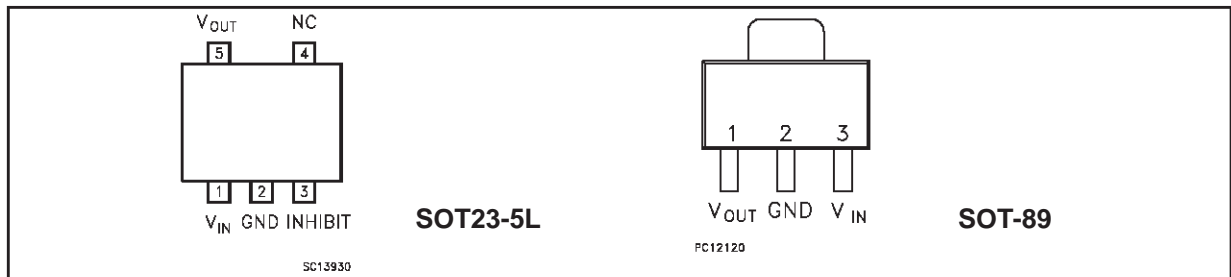

(*) Inhibit pin is not internally pulled-up then it must not be left floating. Disable the device when connected to GND or to a positive voltage less than 0.18V

ORDERING NUMBERS

AB VERSION		C VERSION		Output Voltage
SOT23-5L	SOT-89	SOT23-5L	SOT-89	
LD2981ABM28TR	LD2981ABU28TR	LD2981CM28TR	LD2981CU28TR	2.85 V
LD2981ABM30TR	LD2981ABU30TR	LD2981CM30TR	LD2981CU30TR	3.0 V
LD2981ABM32TR	LD2981ABU32TR	LD2981CM32TR	LD2981CU32TR	3.2 V
LD2981ABM33TR	LD2981ABU33TR	LD2981CM33TR	LD2981CU33TR	3.3 V
LD2981ABM38TR	LD2981ABU38TR	LD2981CM38TR	LD2981CU38TR	3.8 V
LD2981ABM48TR	LD2981ABU48TR	LD2981CM48TR	LD2981CU48TR	4.85 V
LD2981ABM50TR	LD2981ABU50TR	LD2981CM50TR	LD2981CU50TR	5.0 V

APPLICATION CIRCUIT

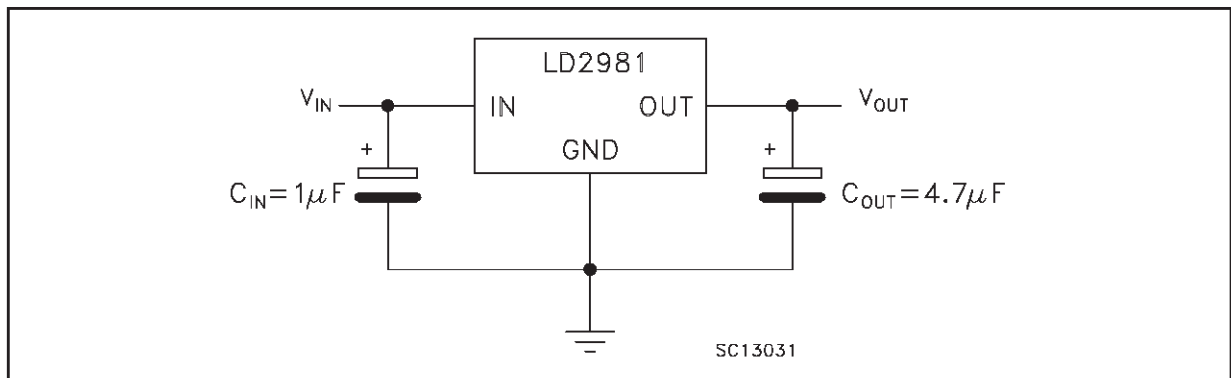

ELECTRICAL CHARACTERISTICS FOR LD2981AB (refer to the test circuits, $T_J = 25\text{ }^\circ\text{C}$,
 $V_{IN} = V_{O(NOM)} + 1$, $C_O = 1\text{ }\mu\text{F}$, $I_O = 1\text{ mA}$, $V_{INH} = 2\text{ V}$, unless otherwise specified)

Symbol	Parameter	Test Conditions	Min.	Typ.	Max.	Unit
V_o	Output Voltage	$V_{IN} = 3.85\text{ V}$	2.828	2.85	2.872	V
		$1 < I_o < 100\text{ mA}$	2.822		2.878	V
		$1 < I_o < 100\text{ mA}, -40 < T_J < 125\text{ }^\circ\text{C}$	2.779		2.921	V
V_o	Output Voltage	$V_{IN} = 4\text{ V}$	2.977	3	3.023	V
		$1 < I_o < 100\text{ mA}$	2.970		3.030	V
		$1 < I_o < 100\text{ mA}, -40 < T_J < 125\text{ }^\circ\text{C}$	2.925		3.075	V
V_o	Output Voltage	$V_{IN} = 4.2\text{ V}$	3.176	3.2	3.224	V
		$1 < I_o < 100\text{ mA}$	3.168		3.232	V
		$1 < I_o < 100\text{ mA}, -40 < T_J < 125\text{ }^\circ\text{C}$	3.12		3.28	V
V_o	Output Voltage	$V_{IN} = 4.3\text{ V}$	3.275	3.3	3.325	V
		$1 < I_o < 100\text{ mA},$	3.267		3.333	V
		$1 < I_o < 100\text{ mA}, -40 < T_J < 125\text{ }^\circ\text{C}$	3.217		3.383	V
V_o	Output Voltage	$V_{IN} = 4.8\text{ V}$	3.771	3.8	3.829	V
		$1 < I_o < 100\text{ mA},$	3.762		3.838	V
		$1 < I_o < 100\text{ mA}, -40 < T_J < 125\text{ }^\circ\text{C}$	3.705		3.895	V
V_o	Output Voltage	$V_{IN} = 5.85\text{ V}$	4.813	4.85	4.887	V
		$1 < I_o < 100\text{ mA},$	4.801		4.899	V
		$1 < I_o < 100\text{ mA}, -40 < T_J < 125\text{ }^\circ\text{C}$	4.729		4.971	V
V_o	Output Voltage	$V_{IN} = 6\text{ V}$	4.962	5	5.038	V
		$1 < I_o < 100\text{ mA},$	4.950		5.050	V
		$1 < I_o < 100\text{ mA}, -40 < T_J < 125\text{ }^\circ\text{C}$	4.875		5.125	V
I_{out}	Output Current Limit		150			mA
ΔV_o	Line Regulation	$V_{O(NOM)} + 1 < V_{IN} < 16\text{ V}, I_o = 1\text{ mA}$ $-40 < T_J < 125\text{ }^\circ\text{C}$		0.003	0.014	%/ V_{in}
I_d	Quiescent Current	ON MODE				
		$I_o = 0\text{ mA}$		80	100	μA
		$I_o = 0\text{ mA}, -40 < T_J < 125\text{ }^\circ\text{C}$			150	μA
		$I_o = 1\text{ mA}$		100	150	μA
		$I_o = 1\text{ mA}, -40 < T_J < 125\text{ }^\circ\text{C}$			200	μA
		$I_o = 25\text{ mA}$		250	400	μA
		$I_o = 25\text{ mA}, -40 < T_J < 125\text{ }^\circ\text{C}$			800	μA
		$I_o = 100\text{ mA}$		800	1300	μA
		$I_o = 100\text{ mA}, -40 < T_J < 125\text{ }^\circ\text{C}$			2600	μA
		OFF MODE				
$V_{INH} < 0.3\text{ V}$			0.8	μA		
$V_{INH} < 0.15\text{ V}, -40 < T_J < 125\text{ }^\circ\text{C}$			2	μA		
SVR	Supply Voltage Rejection	$f = 1\text{ KHz}, C_{out} = 10\text{ }\mu\text{F}$		63		dB
V_d	Dropout Voltage	$I_o = 0\text{ mA}$		1	3	mV
		$I_o = 0\text{ mA}, -40 < T_J < 125\text{ }^\circ\text{C}$			5	mV
		$I_o = 1\text{ mA}$		7	10	mV
		$I_o = 1\text{ mA}, -40 < T_J < 125\text{ }^\circ\text{C}$			15	mV
		$I_o = 25\text{ mA}$		70	100	mV
		$I_o = 25\text{ mA}, -40 < T_J < 125\text{ }^\circ\text{C}$			150	mV
		$I_o = 100\text{ mA}$		200	250	mV
$I_o = 100\text{ mA}, -40 < T_J < 125\text{ }^\circ\text{C}$			375	mV		
V_{il}	Control Input Logic Low	LOW = Output OFF $-40 < T_J < 125\text{ }^\circ\text{C}$			0.18	V
V_{ih}	Control Input Logic High	HIGH = Output ON $-40 < T_J < 125\text{ }^\circ\text{C}$	2			V
I_i	Control Input Current	$V_{INH} = 0\text{ V}, -40 < T_J < 125\text{ }^\circ\text{C}$		0	-1	μA
		$V_{INH} = 5\text{ V}, -40 < T_J < 125\text{ }^\circ\text{C}$		5	15	μA
eN	Output Noise Voltage (RMS)	$BW = 300\text{ Hz to } 50\text{ KHz}, C_{out} = 10\text{ }\mu\text{F}$		160		μV
I_{sc}	Short Circuit Current	$R_L = 0$	150			mA

ELECTRICAL CHARACTERISTICS FOR LD2981C (refer to the test circuits, $T_J = 25\text{ }^\circ\text{C}$,
 $V_{IN} = V_{O(NOM)} + 1$, $C_O = 1\text{ }\mu\text{F}$, $I_O = 1\text{ mA}$, $V_{INH} = 2\text{ V}$, unless otherwise specified)

Symbol	Parameter	Test Conditions	Min.	Typ.	Max.	Unit
V_o	Output Voltage	$V_{IN} = 3.85\text{ V}$	2.814	2.85	2.886	V
		$1 < I_o < 100\text{ mA}$	2.793		2.907	V
		$1 < I_o < 100\text{ mA}$, $-40 < T_J < 125\text{ }^\circ\text{C}$	2.750		2.950	V
V_o	Output Voltage	$V_{IN} = 4\text{ V}$	2.962	3	3.038	V
		$1 < I_o < 100\text{ mA}$	2.940		3.060	V
		$1 < I_o < 100\text{ mA}$, $-40 < T_J < 125\text{ }^\circ\text{C}$	2.895		3.105	V
V_o	Output Voltage	$V_{IN} = 4.2\text{ V}$	3.160	3.2	3.240	V
		$1 < I_o < 100\text{ mA}$	3.136		3.264	V
		$1 < I_o < 100\text{ mA}$, $-40 < T_J < 125\text{ }^\circ\text{C}$	3.088		3.312	V
V_o	Output Voltage	$V_{IN} = 4.3\text{ V}$	3.259	3.3	3.341	V
		$1 < I_o < 100\text{ mA}$,	3.234		3.366	V
		$1 < I_o < 100\text{ mA}$, $-40 < T_J < 125\text{ }^\circ\text{C}$	3.184		3.416	V
V_o	Output Voltage	$V_{IN} = 4.8\text{ V}$	3.752	3.8	3.848	V
		$1 < I_o < 100\text{ mA}$,	3.724		3.876	V
		$1 < I_o < 100\text{ mA}$, $-40 < T_J < 125\text{ }^\circ\text{C}$	3.667		3.933	V
V_o	Output Voltage	$V_{IN} = 5.85\text{ V}$	4.789	4.85	4.911	V
		$1 < I_o < 100\text{ mA}$,	4.753		4.947	V
		$1 < I_o < 100\text{ mA}$, $-40 < T_J < 125\text{ }^\circ\text{C}$	4.680		5.020	V
V_o	Output Voltage	$V_{IN} = 6\text{ V}$	4.937	5	5.063	V
		$1 < I_o < 100\text{ mA}$,	4.900		5.100	V
		$1 < I_o < 100\text{ mA}$, $-40 < T_J < 125\text{ }^\circ\text{C}$	4.825		5.175	V
I_{out}	Output Current Limit		150			mA
ΔV_o	Line Regulation	$V_{O(NOM)} + 1 < V_{IN} < 16\text{ V}$, $I_o = 1\text{ mA}$ $-40 < T_J < 125\text{ }^\circ\text{C}$		0.003	0.014 0.032	%/ V_{in}
I_d	Quiescent Current	ON MODE				
		$I_o = 0\text{ mA}$		80	100	μA
		$I_o = 0\text{ mA}$ $-40 < T_J < 125\text{ }^\circ\text{C}$			150	μA
		$I_o = 1\text{ mA}$		100	150	μA
		$I_o = 1\text{ mA}$ $-40 < T_J < 125\text{ }^\circ\text{C}$			200	μA
		$I_o = 25\text{ mA}$		250	400	μA
		$I_o = 25\text{ mA}$ $-40 < T_J < 125\text{ }^\circ\text{C}$			800	μA
		$I_o = 100\text{ mA}$		800	1300	μA
		$I_o = 100\text{ mA}$ $-40 < T_J < 125\text{ }^\circ\text{C}$			2600	μA
		OFF MODE				
$V_{INH} < 0.3\text{ V}$			0.8	μA		
$V_{INH} < 0.15\text{ V}$ $-40 < T_J < 125\text{ }^\circ\text{C}$			2	μA		
SVR	Supply Voltage Rejection	$f = 1\text{ KHz}$, $C_{out} = 10\text{ }\mu\text{F}$		63		dB
V_d	Dropout Voltage	$I_o = 0\text{ mA}$		1	3	mV
		$I_o = 0\text{ mA}$ $-40 < T_J < 125\text{ }^\circ\text{C}$			5	mV
		$I_o = 1\text{ mA}$		7	10	mV
		$I_o = 1\text{ mA}$ $-40 < T_J < 125\text{ }^\circ\text{C}$			15	mV
		$I_o = 25\text{ mA}$		70	100	mV
		$I_o = 25\text{ mA}$ $-40 < T_J < 125\text{ }^\circ\text{C}$			150	mV
		$I_o = 100\text{ mA}$		200	250	mV
$I_o = 100\text{ mA}$ $-40 < T_J < 125\text{ }^\circ\text{C}$			375	mV		
V_{il}	Control Input Logic Low	LOW = Output OFF $-40 < T_J < 125\text{ }^\circ\text{C}$			0.18	V
V_{ih}	Control Input Logic High	HIGH = Output ON $-40 < T_J < 125\text{ }^\circ\text{C}$	2			V
I_i	Control Input Current	$V_{INH} = 0\text{ V}$, $-40 < T_J < 125\text{ }^\circ\text{C}$		0	-1	μA
		$V_{INH} = 5\text{ V}$, $-40 < T_J < 125\text{ }^\circ\text{C}$		5	15	μA
eN	Output Noise Voltage (RMS)	BW = 300 Hz to 50 KHz, $C_{out} = 10\text{ }\mu\text{F}$		160		μV
I_{sc}	Short Circuit Current	$R_L = 0$	150			mA

TYPICAL PERFORMANCE CHARACTERISTICS (unless otherwise specified $T_J=25^{\circ}\text{C}$, $C_{IN}=C_{OUT}=1\mu\text{F}$)

Output Voltage vs Temperature

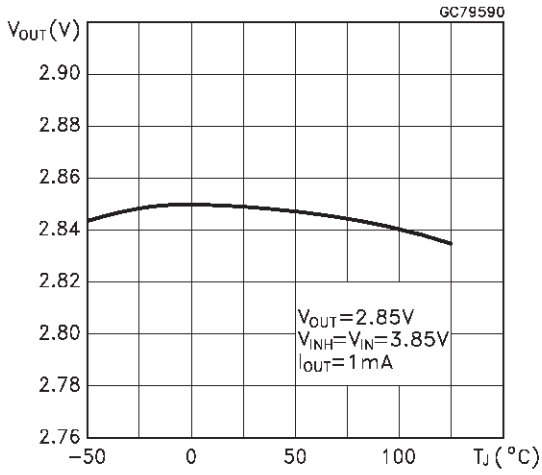

Output Voltage vs Temperature

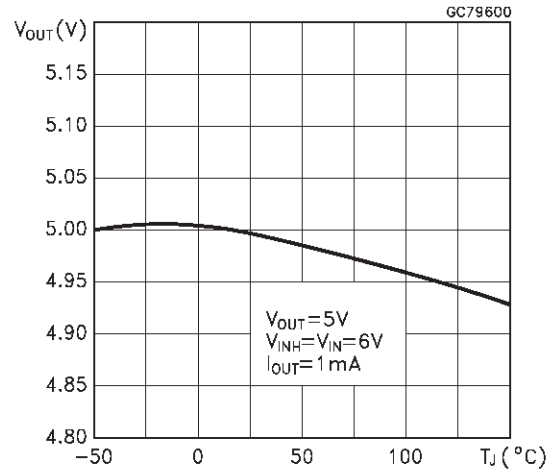

Output Voltage vs Input Voltage

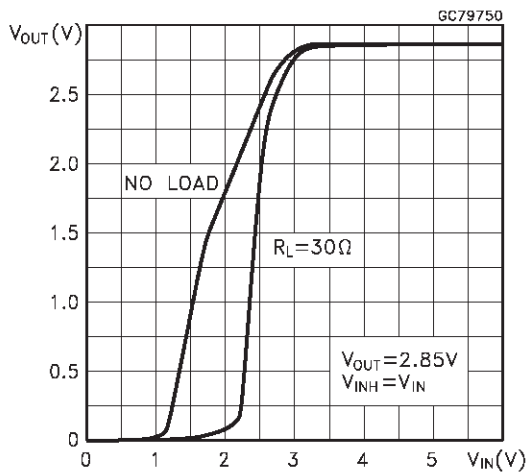

Output Voltage vs Input Voltage

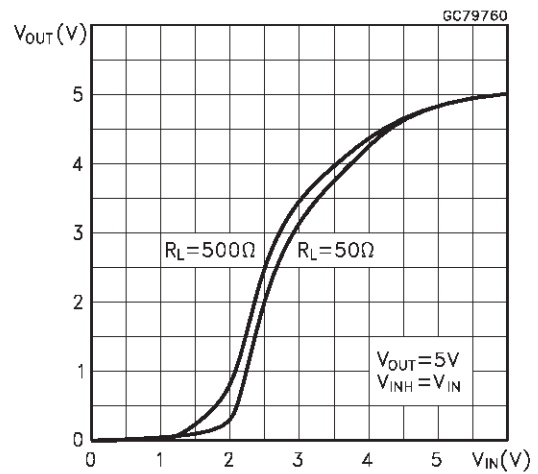

Output Voltage vs Output Current

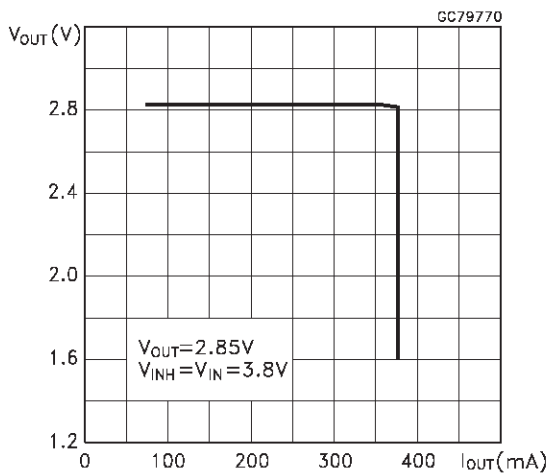

Output Voltage vs Output Current

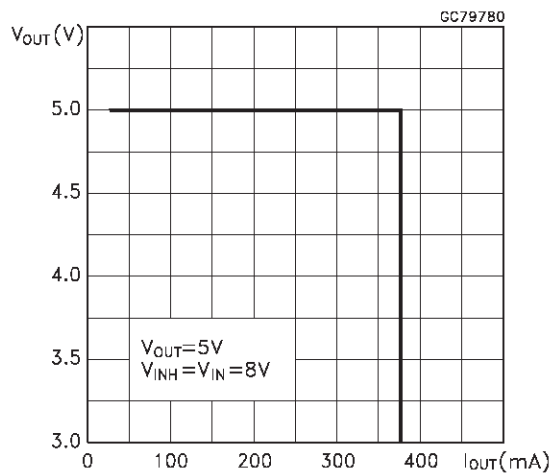

TYPICAL PERFORMANCE CHARACTERISTICS (continued)

Line Regulation vs Temperature

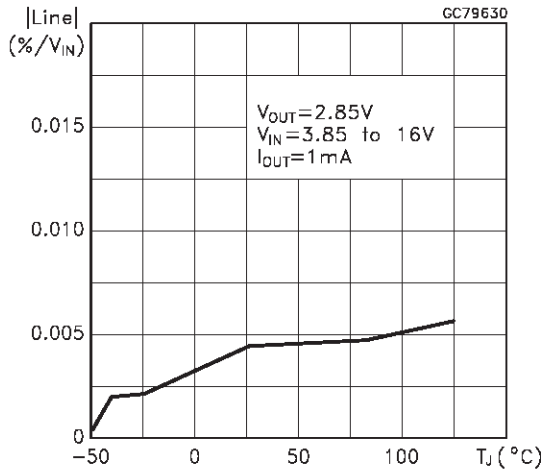

Dropout Voltage vs Temperature

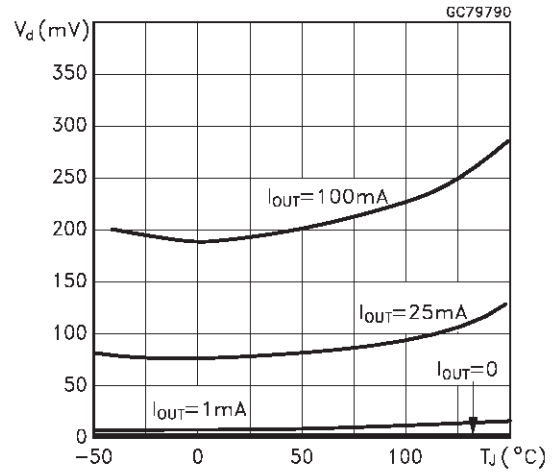

Dropout Voltage vs Output Current

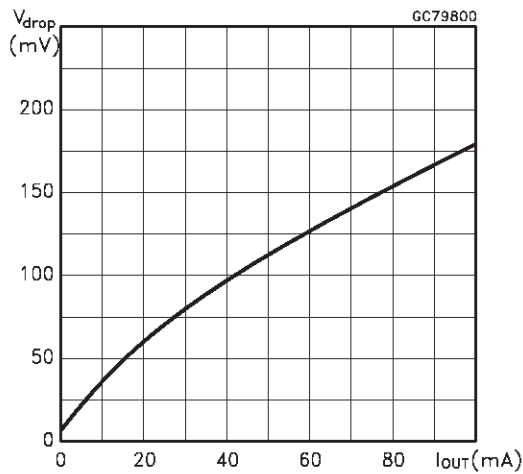

Quiescent Current vs Temperature

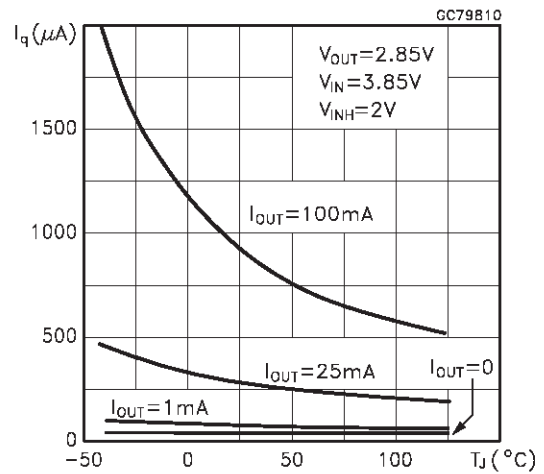

Quiescent Current vs Output Current

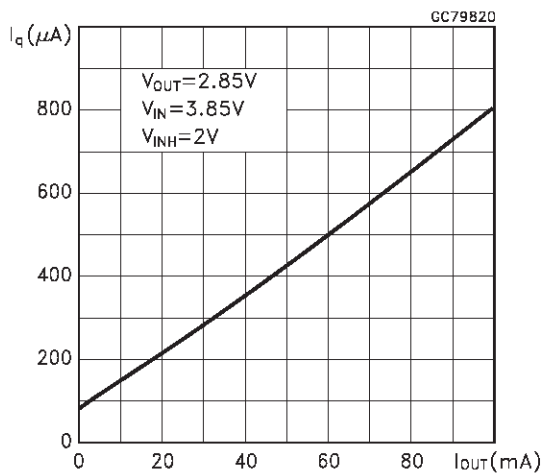

Quiescent Current vs Input Voltage

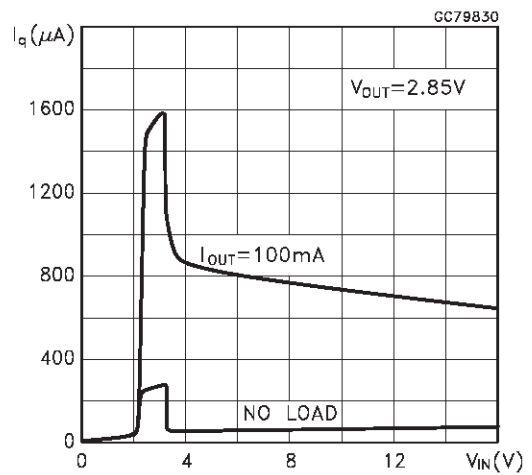

TYPICAL PERFORMANCE CHARACTERISTICS (continued)

S.V.R. vs Frequency

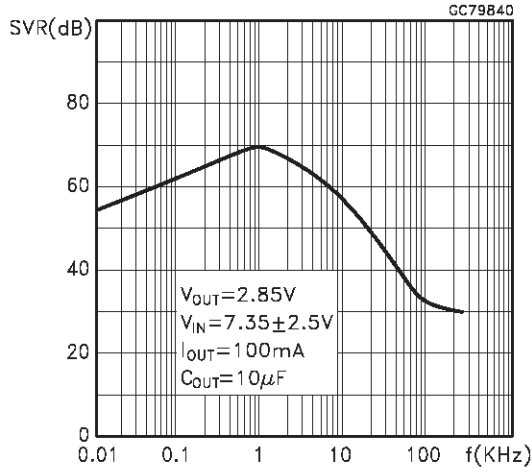

S.V.R. vs Temperature

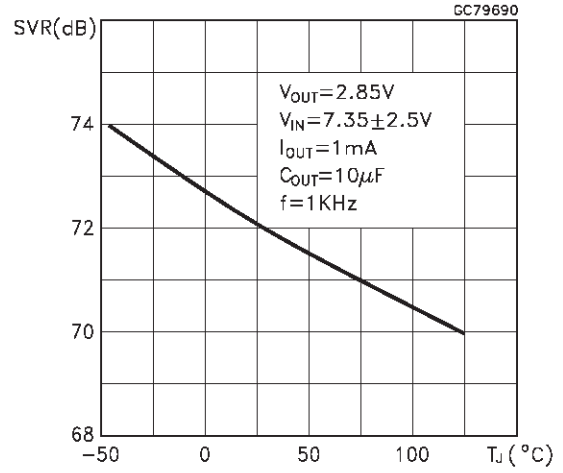

S.V.R. vs Output Current

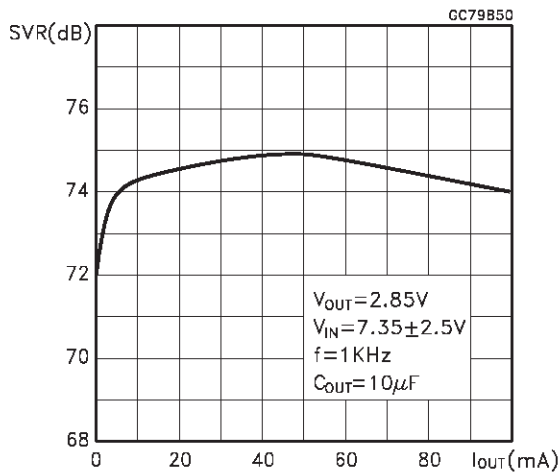

Stability

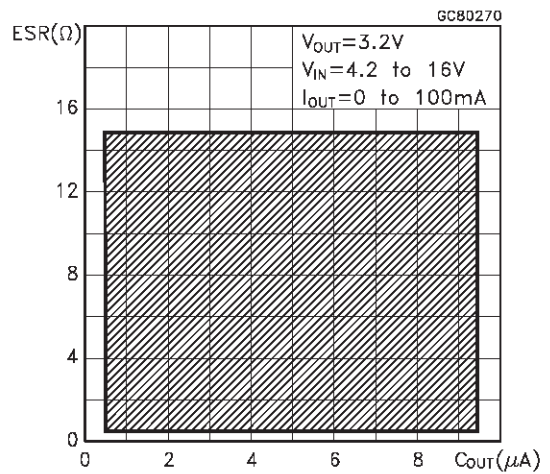

Short Circuit Current vs Dropout Voltage

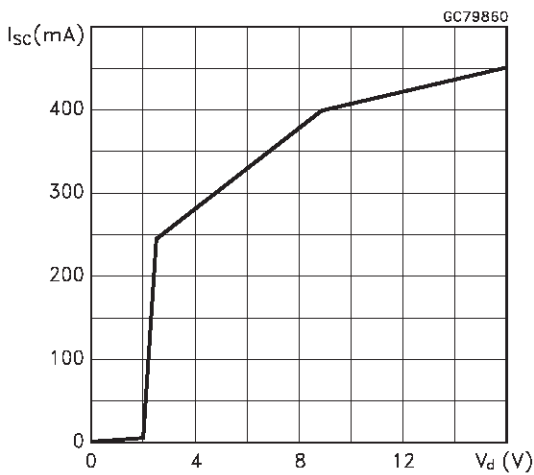

Reverse Current vs Reverse Voltage

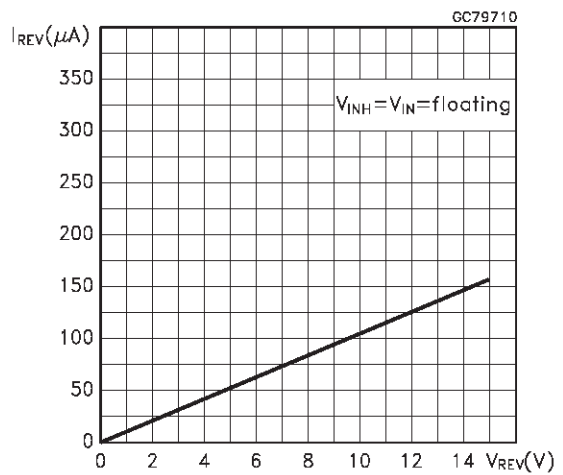

TYPICAL PERFORMANCE CHARACTERISTICS (continued)

Output Voltage vs Inhibit Voltage

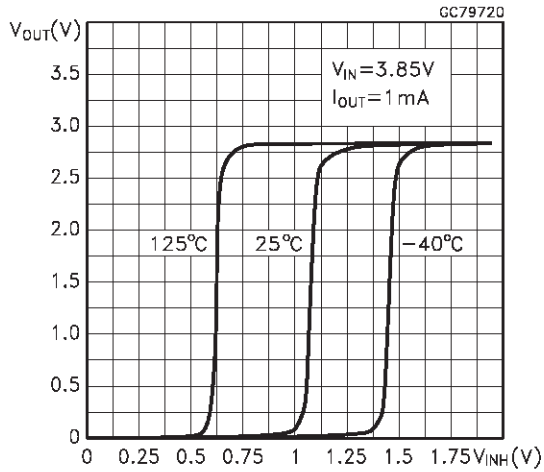

Inhibit Current vs Temperature

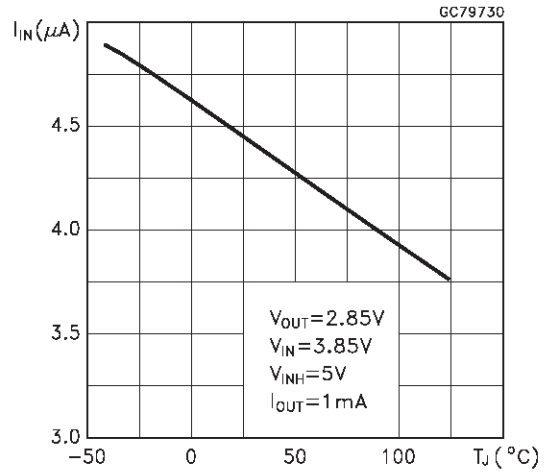

Supply Voltage Rejection at VOUT=2.85V

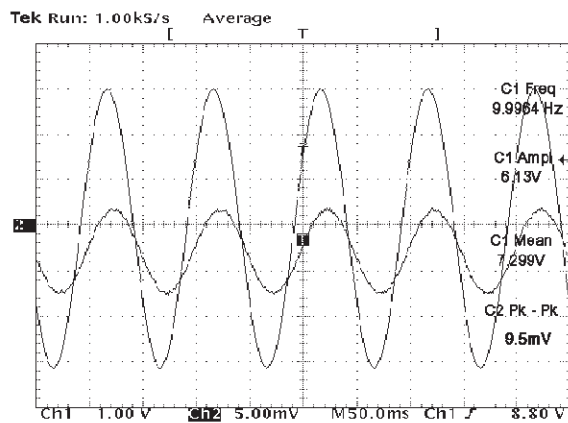

$V_{IN} = 7.35 \pm 2.5V$, $I_{OUT} = 0.1A$, $f = 1KHz$

Supply Voltage Rejection at VOUT=5V

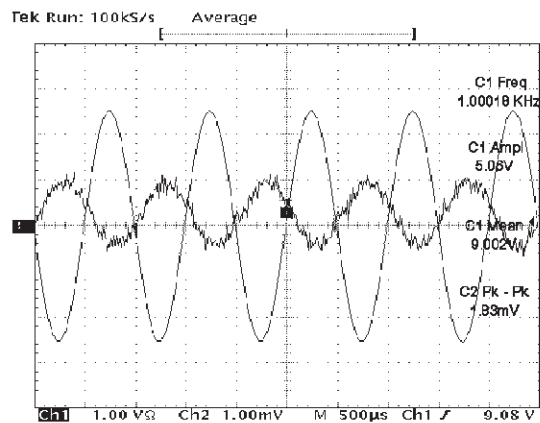

$V_{IN} = 9 \pm 2.5V$, $I_{OUT} = 0.1A$, $f = 1KHz$

Line Transient Response

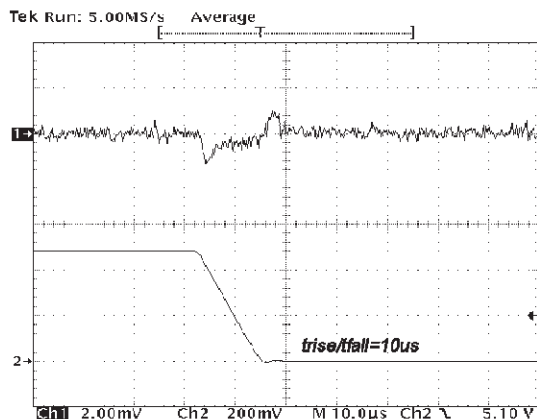

$V_{IN} = 4.75$ to $5.25V$, $I_{OUT} = 0.1A$, $C_o = 10\mu F$ (ESR=1Ω at 1KHz)

Line Transient Response

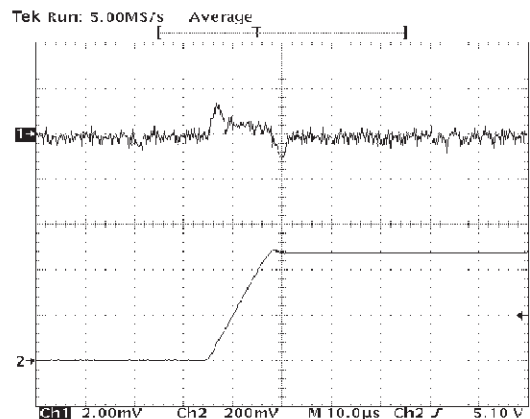

$V_{IN} = 4.75$ to $5.25V$, $I_{OUT} = 0.1A$, $C_o = 10\mu F$ (ESR=1Ω at 1KHz)

TYPICAL PERFORMANCE CHARACTERISTICS (continued)

Load Transient Response

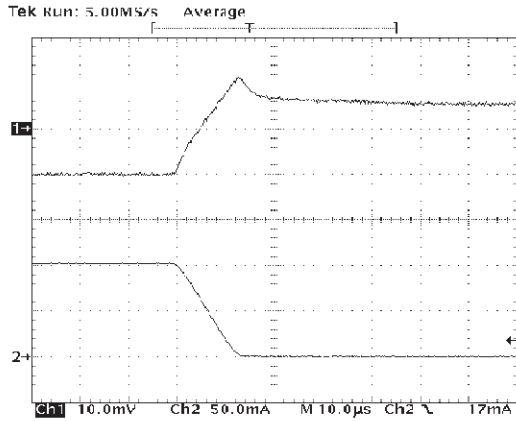

$V_{CC} = 5V, I_{OUT} = 1 \text{ to } 100mA, C_{IN} = 150nF, C_{OUT} = 10\mu F$
(ESR=1Ω at 1KHz)

Load Transient Response

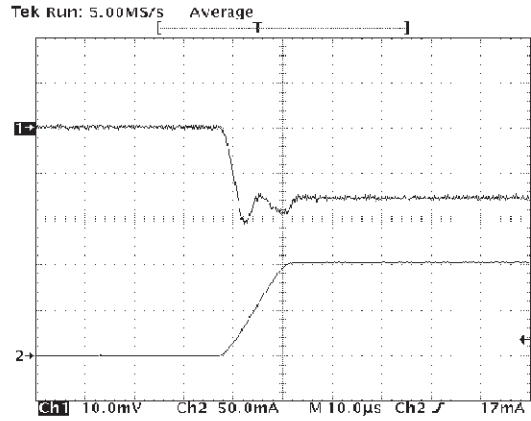

$V_{CC} = 5V, I_{OUT} = 1 \text{ to } 100mA, C_{IN} = 150nF, C_{OUT} = 10\mu F$
(ESR=1Ω at 1KHz)

Shutdown Transient Response

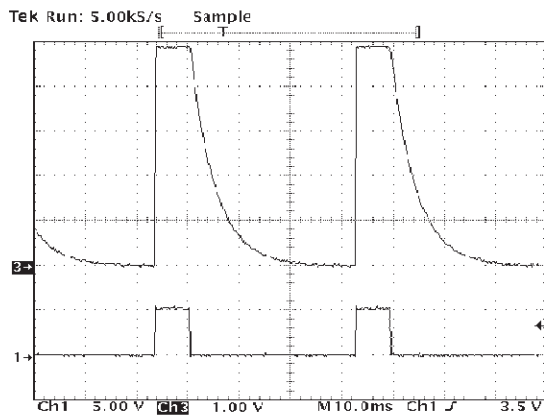

$V_{OUT} = 5V, V_{IN} = 6V, V_{INH} = 0 \text{ to } 5V, C_{IN} = C_{OUT} = 1 \mu F$ (Tant.)

SOT23-5L MECHANICAL DATA

DIM.	mm			mils		
	MIN.	TYP.	MAX.	MIN.	TYP.	MAX.
A	0.90		1.45	35.4		57.1
A1	0.00		0.15	0.0		5.9
A2	0.90		1.30	35.4		51.2
b	0.35		0.50	13.7		19.7
C	0.09		0.20	3.5		7.8
D	2.80		3.00	110.2		118.1
E	2.60		3.00	102.3		118.1
E1	1.50		1.75	59.0		68.8
L	0.35		0.55	13.7		21.6
e		0.95			37.4	
e1		1.9			74.8	

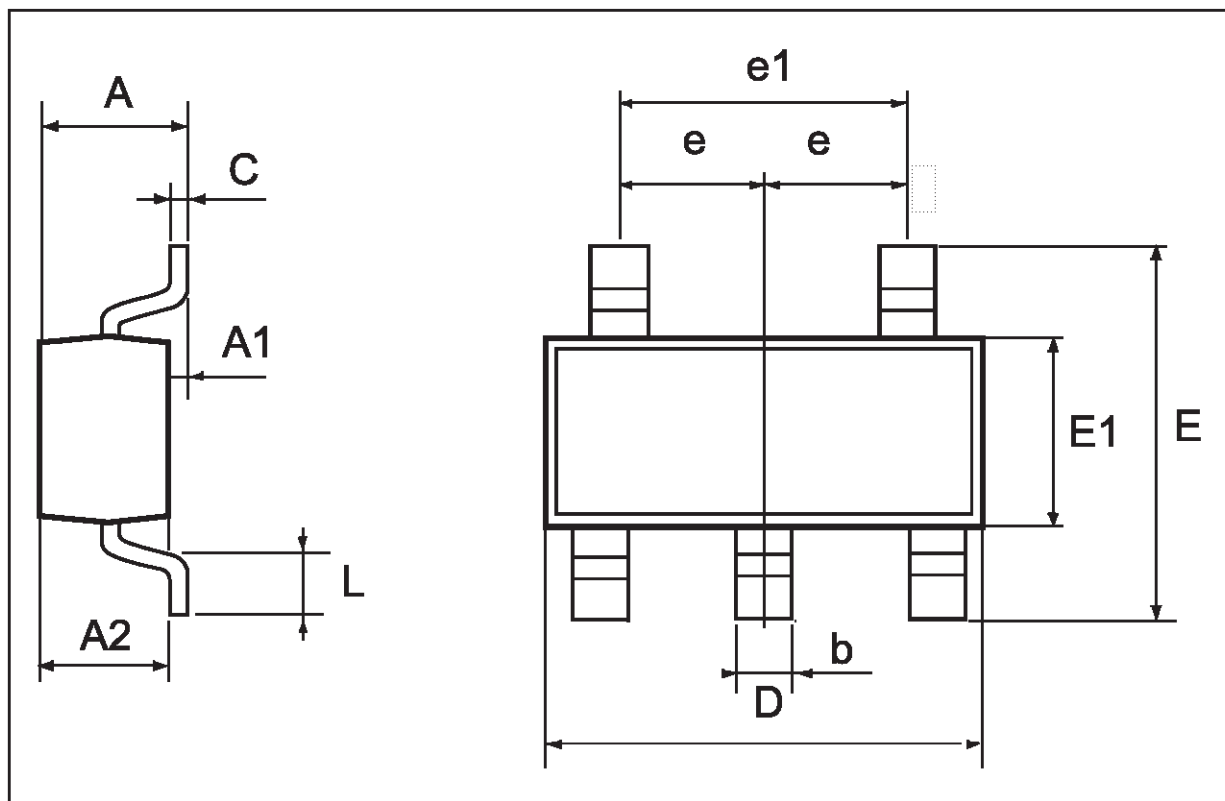

Information furnished is believed to be accurate and reliable. However, STMicroelectronics assumes no responsibility for the consequences of use of such information nor for any infringement of patents or other rights of third parties which may result from its use. No license is granted by implication or otherwise under any patent or patent rights of STMicroelectronics. Specification mentioned in this publication are subject to change without notice. This publication supersedes and replaces all information previously supplied. STMicroelectronics products are not authorized for use as critical components in life support devices or systems without express written approval of STMicroelectronics.

The ST logo is a trademark of STMicroelectronics

© 1999 STMicroelectronics – Printed in Italy – All Rights Reserved

STMicroelectronics GROUP OF COMPANIES

Australia - Brazil - Canada - China - France - Germany - Italy - Japan - Korea - Malaysia - Malta - Mexico - Morocco - The Netherlands - Singapore - Spain - Sweden - Switzerland - Taiwan - Thailand - United Kingdom - U.S.A.

<http://www.st.com>