



# L78LR05

## 150mA, 5V 5-Pin Voltage Regulator with Reset Function

### Overview

The L78LR05 is voltage regulator IC that performs the reset signal generating function when the power supply of a microcomputer system is turned ON/OFF. The L78LR05 is convenient for battery backup system at the time of power failure. The reset threshold voltage  $V_{RT}$  is ranked as shown below.

$V_{RT}$ rank	B	C	D	E	F	G	H
$V_{RT}$ (V)	4.8	4.5	4.2	3.9	3.6	3.3	3.0

### Applications

- Prevention of malfunction that may occur when the power supply of a microcomputer is turned ON/OFF.
- Measures taken against abnormal operations that may occur at the time of instantaneous break of power supply.
- Direct battery backup for SRAM.

### Features

- 5V, 150mA output.
- Capable of generating a microcomputer reset signal.
- No battery-regulator switching circuit required at the battery backup mode (Output leakage current :  $2\mu\text{A}$  or less).
- An external capacitor can be used to set the reset output delay time.
- Applicable to the power supply of CMOS, NMOS microcomputers.
- Especially suited for use as an on-board regulator for a microcomputer system.
- Small-sized power package TP-5H permitting the equipment to be made compact.
- The allowable power dissipation can be increased by being surface-mounted on the board.
- Capable of being mounted in a variety of methods because of various lead forming versions available.
- On-chip protectors (overcurrent limiter, ASO protector, thermal protector).

### Package Dimensions

unit:mm

3103

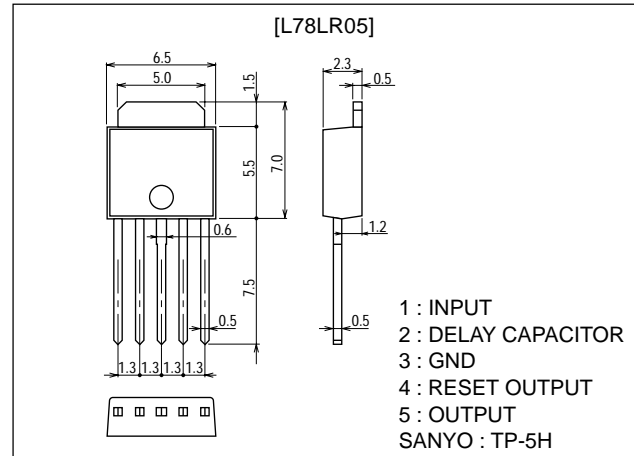

■ Any and all SANYO products described or contained herein do not have specifications that can handle applications that require extremely high levels of reliability, such as life-support systems, aircraft's control systems, or other applications whose failure can be reasonably expected to result in serious physical and/or material damage. Consult with your SANYO representative nearest you before using any SANYO products described or contained herein in such applications.

■ SANYO assumes no responsibility for equipment failures that result from using products at values that exceed, even momentarily, rated values (such as maximum ratings, operating condition ranges, or other parameters) listed in products specifications of any and all SANYO products described or contained herein.

**SANYO Electric Co., Ltd. Semiconductor Company**

TOKYO OFFICE Tokyo Bldg., 1-10, 1 Chome, Ueno, Taito-ku, TOKYO, 110-8534 JAPAN

D1599TH (KT)/61093TS/8039YT/5178TA/7067TA, TS No.2622-1/6

# L78LR05

## Specifications

### Maximum Ratings at $T_a = 25^\circ\text{C}$

Parameter	Symbol	Conditions	Ratings	Unit
Maximum Input Voltage	$V_{IN\text{ max}}$		25	V
Allowable Power Dissipation	$P_d\text{ max}$	(No fin)	1.0	W
Operating Temperature	$T_{opr}$		-30 to +80	$^\circ\text{C}$
Storage Temperature	$T_{stg}$		-55 to +150	$^\circ\text{C}$

### Operating Conditions at $T_a = 25^\circ\text{C}$

Parameter	Symbol	Conditions	Ratings	Unit
Input Voltage	$V_{IN}$		7.5 to 20	V
Output Current	$I_{OUT}$		1 to 150	mA

### Operating Characteristics at $T_a = 25^\circ\text{C}$ , $V_{IN}=10\text{V}$ , $I_{OUT}=40\text{mA}$ , $c_{in}=1\mu\text{F}$ , $c_o=10\mu\text{F}$

Parameter	Symbol	Conditions	Ratings			Unit
			min	typ	max	
Output Voltage	$V_{OUT1}$	$T_j=25^\circ\text{C}$	4.8	5.0	5.2	V
	$V_{OUT2}$	$7\text{V}\leq V_{IN}\leq 20\text{V}$ , $1\text{mA}\leq I_{OUT}\leq 70\text{mA}$	4.75		5.25	V
Line Regulation	$\Delta V_o\text{ LINE1}$	$T_j=25^\circ\text{C}$ , $7\text{V}\leq V_{IN}\leq 20\text{V}$		6.0	75	mV
	$\Delta V_o\text{ LINE2}$	$T_j=25^\circ\text{C}$ , $8\text{V}\leq V_{IN}\leq 20\text{V}$		3.0	50	mV
Load Regulation	$\Delta V_o\text{ LOAD1}$	$T_j=25^\circ\text{C}$ , $1\text{mA}\leq I_{OUT}\leq 100\text{mA}$		9.0	60	mV
	$\Delta V_o\text{ LOAD2}$	$T_j=25^\circ\text{C}$ , $1\text{mA}\leq I_{OUT}\leq 40\text{mA}$		3.0	30	mV
Current Dissipation	$I_{CC}$	$T_j=25^\circ\text{C}$ , $I_{OUT}=100\text{mA}$		1.4	3.4	mA
Current Dissipation Variation	$\Delta I_{CC}\text{ LINE}$	$8\text{V}\leq V_{IN}\leq 20\text{V}$		0.12	1.5	mA
	$\Delta I_{CC}\text{ LOAD}$	$1\text{mA}\leq I_{OUT}\leq 40\text{mA}$		0.01	0.1	mA
Output Noise Voltage	$V_{NO}$	$10\text{Hz}\leq f\leq 100\text{kHz}$ , $I_o=1\text{mA}$		80		$\mu\text{V}$
Temperature Coefficient of Output Voltage	$\Delta V_{OUT}/\Delta T_j$	$I_{OUT}=1\text{mA}$ , $T_j=25$ to $125^\circ\text{C}$		$\pm 0.5$		$\text{mV}/^\circ\text{C}$
Ripple Rejection	$R_{rej}$	$T_j=25^\circ\text{C}$ , $f=120\text{Hz}$ , $8\text{V}\leq V_{IN}\leq 18\text{V}$		79		dB
Dropout Voltage	$V_{DROP}$	$T_j=25^\circ\text{C}$		1.5	2.2	V
Output Short Current	$I_{OSC}$	$T_j=25^\circ\text{C}$	150	300	450	mA
"H"-Reset Output Voltage	$V_{ORH}$	$T_j=25^\circ\text{C}$	4.8	5.0	5.2	V
"L"-Reset Output Voltage	$V_{ORL}$	$T_j=25^\circ\text{C}$ , $V_{IN}=3\text{V}$ , $I_o=1\text{mA}$		10	200	mV
Reset Threshold Voltage	$V_{RT}$	B, $T_j=25^\circ\text{C}$	4.60	4.8	4.95	V
		C, $T_j=25^\circ\text{C}$	4.30	4.5	4.65	V
		D, $T_j=25^\circ\text{C}$	4.00	4.2	4.35	V
		E, $T_j=25^\circ\text{C}$	3.70	3.9	4.05	V
		F, $T_j=25^\circ\text{C}$	3.40	3.6	3.75	V
		G, $T_j=25^\circ\text{C}$	3.10	3.3	3.45	V
		H, $T_j=25^\circ\text{C}$	2.80	3.0	3.15	V
		Reset Threshold Hysteresis Voltage	$V_{RTH}$		50	100
Reset Output Delay Time	$t_d$	$c_d=0.1\mu\text{F}$	7.5	10	12.5	ms
Output Pin Leakage Current	$I_{O\text{ LEAK}}$	$V_{IN}=0$ , $V_o=6\text{V}$		0.001	2	$\mu\text{A}$
Reset Output Pin Leakage Current	$I_{OR\text{ LEAK}}$	$V_{IN}=0$ , $V_{OR}=6\text{V}$		0.001	2	A

### Equivalent Circuit Block Diagram

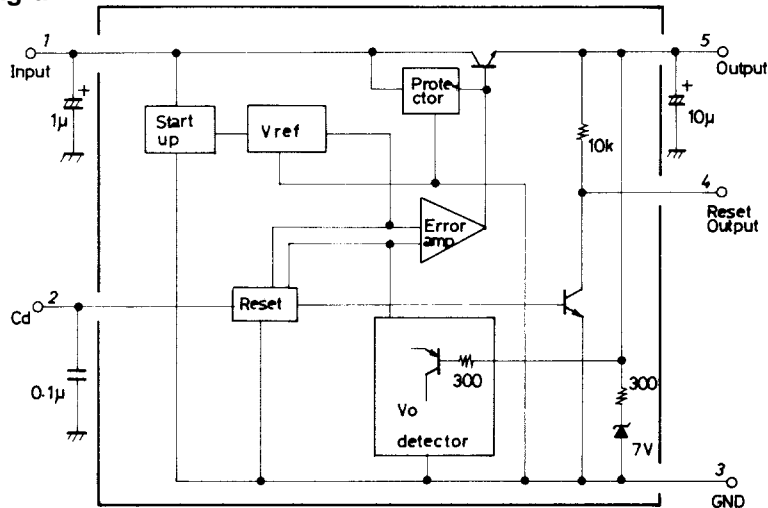

Unit (resistance:  $\Omega$ , capacitance: F)

# L78LR05

## Sample Application Circuit 1

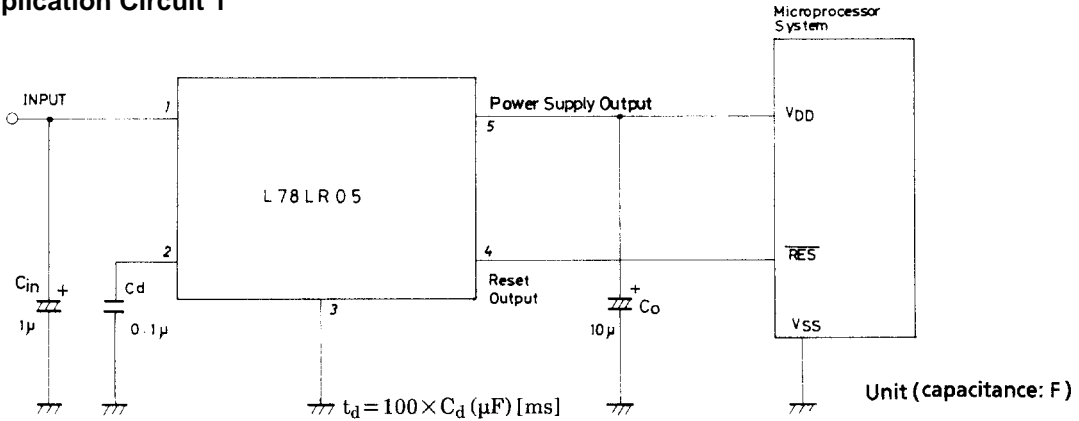

Note 1 : When the capacitance of  $C_d$  is large, the capacitor may not discharge completely, causing  $t_d$  to be made shorter than a set value. If this is a problem, either connect a high speed diode (DS442) between pin2 (anode side) and pin5 (cathode side) or ensure an adequate discharge time by using values for capacitors  $C_{in}$  and  $C_d$  such that  $C_{in} > C_d$ .

Note 2 : If a pull-up resistor is connected to the reset output pin externally, it is possible to cause a sink current up to 4mA to flow.

## Reset Operation

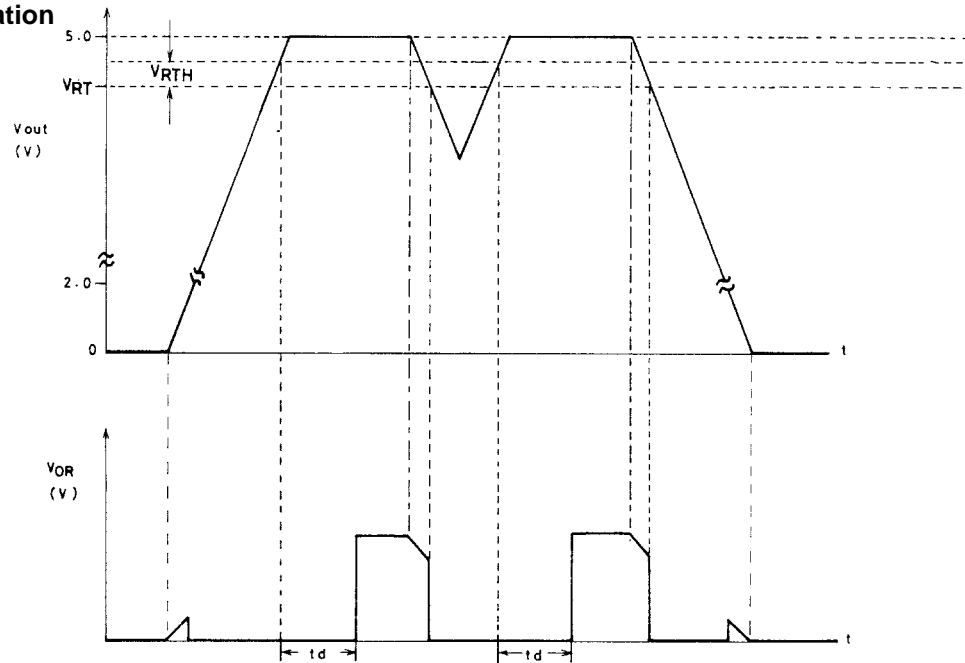

## Sample Application Circuit 2 (Direct battery backup)

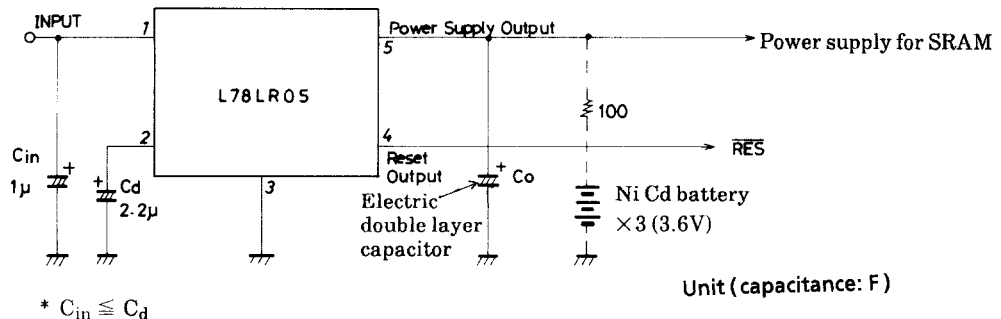

Since the leakage current at the output pin (pin5) of the L78LR05 is so low as  $2\mu A$  or less, a backup circuit can be implemented by connecting an electric double layer capacitor (super capacitor : NEC, gold capacitor : Matsushita Electric) or a Ni Cd battery direct to the output pin. Since a reverse blocking diode, which has been so far connected to the output pin, is not required, a regulated power-supply voltage can be supplied to a load during the steady-state operation, without voltage drop caused by the diode and effects of temperature characteristics, current characteristics of the diode. No battery-regulator switching circuit is required at the battery backup start mode.

Note 3 : The capacitance of reset output signal delay capacitor  $C_d$  must exceed that of input capacitor  $C_{in}$ . If the capacitance of  $C_d$  is small, a reset pulse signal may be generated once when the main power source is turned off (at the battery backup start mode).

# L78LR05

## Allowable Power Dissipation

The allowable power dissipation is 1.0W ( $T_a=25^\circ\text{C}$ ) with fin attached. When the L78LR05 is surface-mounted on a hybrid IC board or printed circuit board, a high allowable power dissipation can be obtained, though it is placed in a small-sized package. Shown below is the relationship between the Cu-foiled area the allowable power dissipation when the L78LR05 is surface-mounted on a glass epoxy board ( $50\times 50\times 0.8\text{mm}^3$ ).

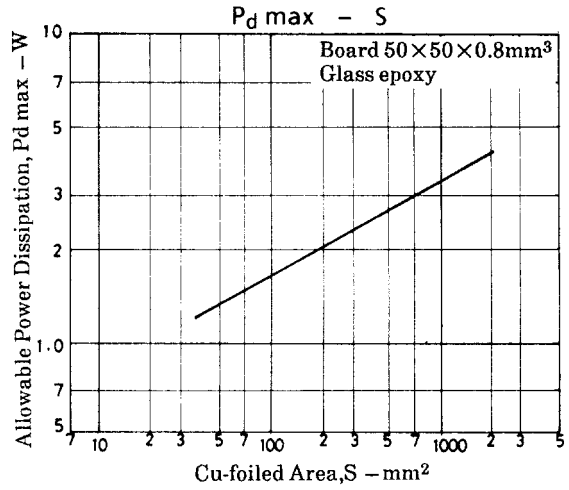
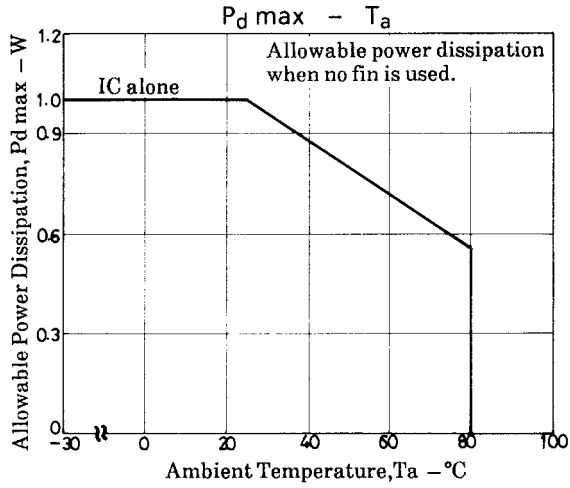

\* The measured values of  $P_d$  represent the values measured when solder on the Cu-foiled area is all wet.

## Lead Forming

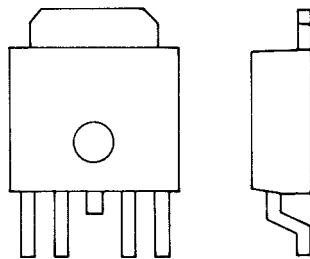
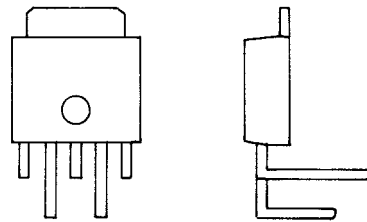
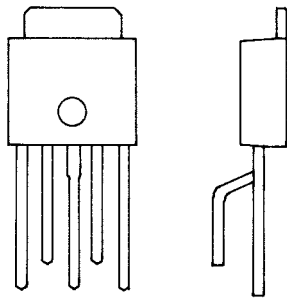

# L78LR05

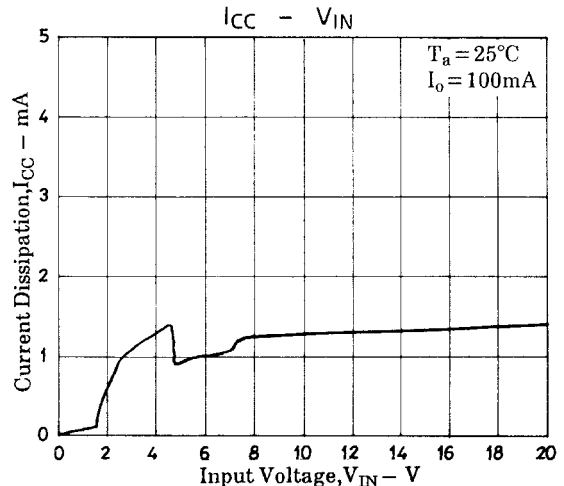
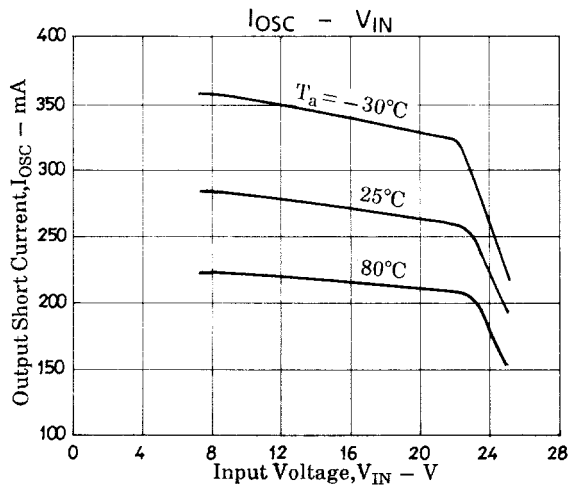
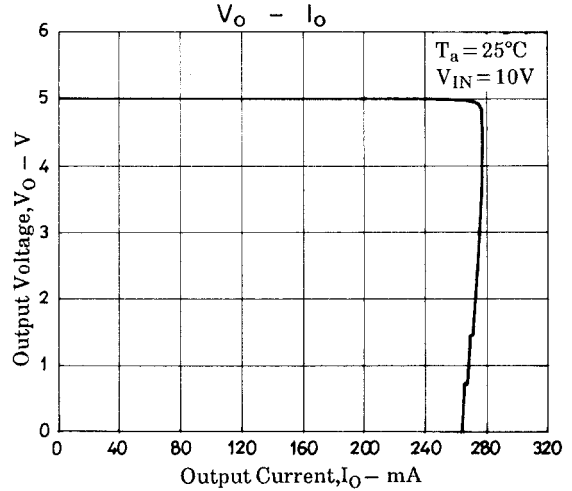
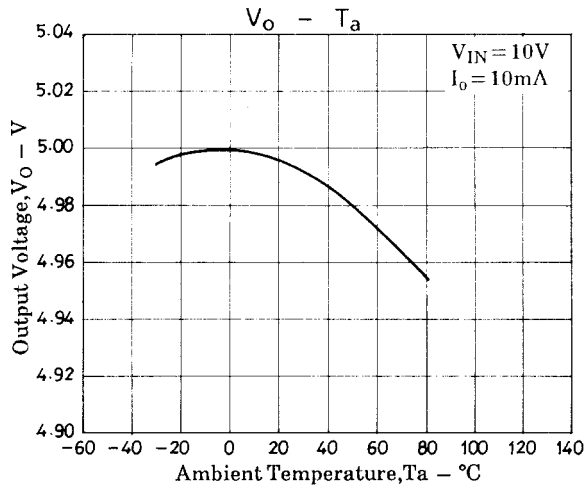
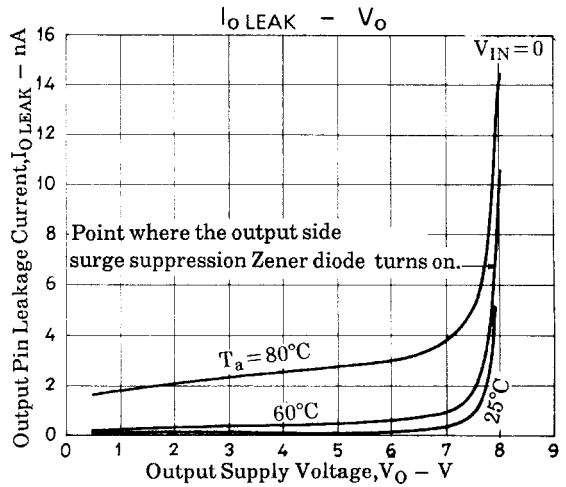
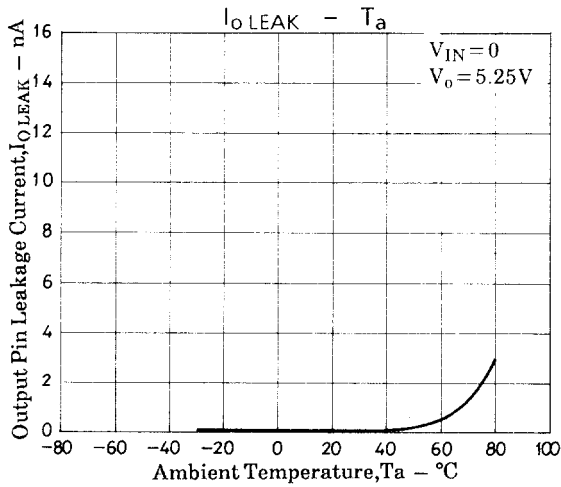
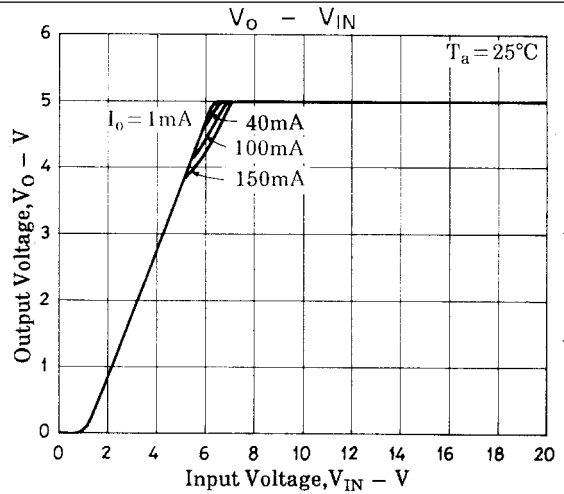
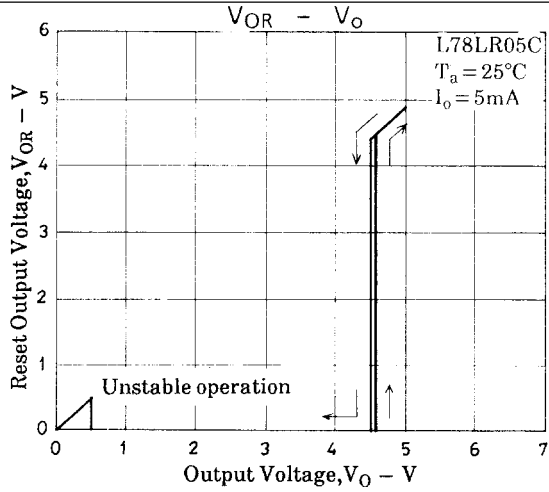

# L78LR05

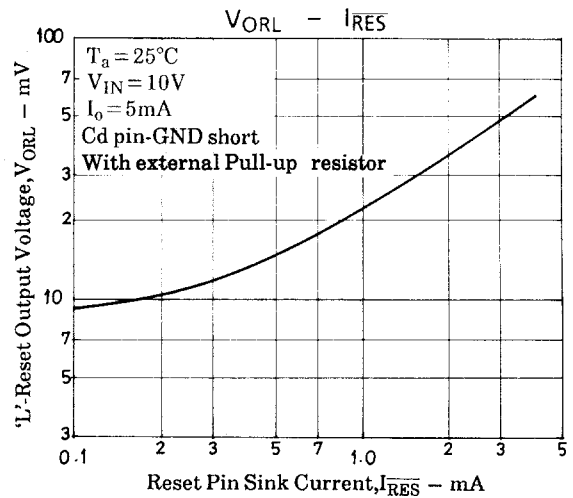
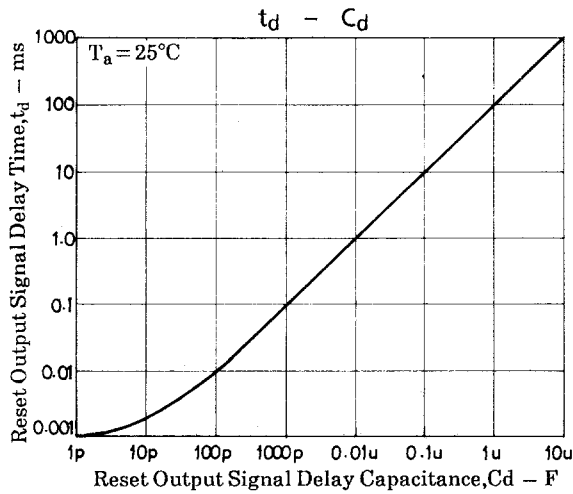
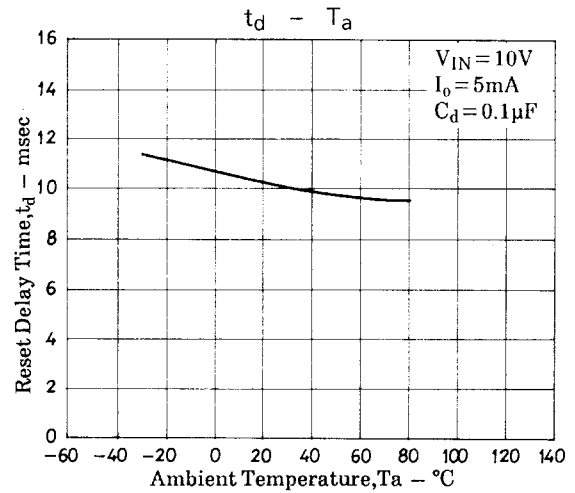
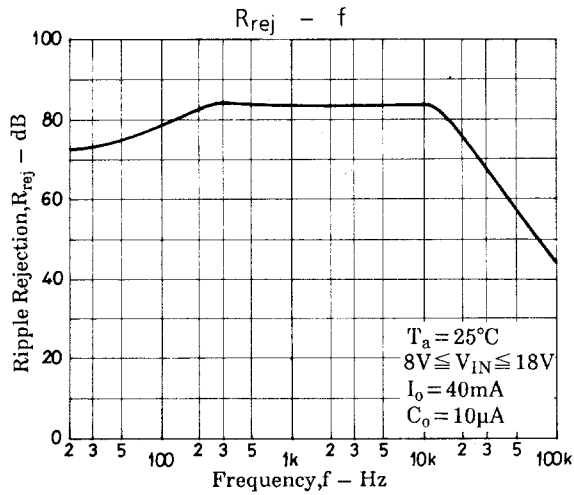

- Specifications of any and all SANYO products described or contained herein stipulate the performance, characteristics, and functions of the described products in the independent state, and are not guarantees of the performance, characteristics, and functions of the described products as mounted in the customer's products or equipment. To verify symptoms and states that cannot be evaluated in an independent device, the customer should always evaluate and test devices mounted in the customer's products or equipment.
- SANYO Electric Co., Ltd. strives to supply high-quality high-reliability products. However, any and all semiconductor products fail with some probability. It is possible that these probabilistic failures could give rise to accidents or events that could endanger human lives, that could give rise to smoke or fire, or that could cause damage to other property. When designing equipment, adopt safety measures so that these kinds of accidents or events cannot occur. Such measures include but are not limited to protective circuits and error prevention circuits for safe design, redundant design, and structural design.
- In the event that any or all SANYO products (including technical data, services) described or contained herein are controlled under any of applicable local export control laws and regulations, such products must not be exported without obtaining the export license from the authorities concerned in accordance with the above law.
- No part of this publication may be reproduced or transmitted in any form or by any means, electronic or mechanical, including photocopying and recording, or any information storage or retrieval system, or otherwise, without the prior written permission of SANYO Electric Co., Ltd.
- Any and all information described or contained herein are subject to change without notice due to product/technology improvement, etc. When designing equipment, refer to the "Delivery Specification" for the SANYO product that you intend to use.
- Information (including circuit diagrams and circuit parameters) herein is for example only; it is not guaranteed for volume production. SANYO believes information herein is accurate and reliable, but no guarantees are made or implied regarding its use or any infringements of intellectual property rights or other rights of third parties.

This catalog provides information as of December, 1999. Specifications and information herein are subject to change without notice.