

IRFH3707PbF

HEXFET® Power MOSFET

Applications

- Synchronous Buck Converter for Computer Processor Power
- Isolated DC to DC Converters for Network and Telecom
- Buck Converters for Set-Top Boxes
- System/load switch

V_{DS}	$R_{DS(on)}$ max	Qg
30V	12.4mΩ @ $V_{GS} = 10V$	5.4nC

Benefits

- Low $R_{DS(ON)}$
- Very Low Gate Charge
- Low Junction to PCB Thermal Resistance
- Fully Characterized Avalanche Voltage and Current
- 100% Tested for R_G
- Lead-Free (Qualified up to 260°C Reflow)
- RoHS compliant (Halogen Free)

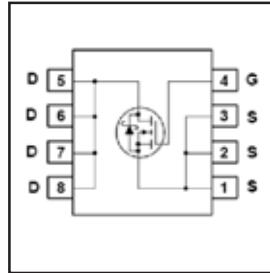

Absolute Maximum Ratings

	Parameter	Max.	Units
V_{DS}	Drain-to-Source Voltage	30	V
V_{GS}	Gate-to-Source Voltage	± 20	
$I_D @ T_A = 25^\circ C$	Continuous Drain Current, $V_{GS} @ 10V$	12	A
$I_D @ T_A = 70^\circ C$	Continuous Drain Current, $V_{GS} @ 10V$	9.4	
$I_D @ T_C = 25^\circ C$	Continuous Drain Current, $V_{GS} @ 10V$	29	
I_{DM}	Pulsed Drain Current ①	96	
$P_D @ T_A = 25^\circ C$	Power Dissipation ⑤	2.8	W
$P_D @ T_A = 70^\circ C$	Power Dissipation ⑤	1.8	
	Linear Derating Factor ⑤	0.02	W/°C
T_J	Operating Junction and	-55 to + 150	°C
T_{STG}	Storage Temperature Range		

Thermal Resistance

	Parameter	Typ.	Max.	Units
$R_{\theta JC}$	Junction-to-Case ④	—	7.5	°C/W
$R_{\theta JA}$	Junction-to-Ambient ⑤⑥	—	45	
$R_{\theta JA}$	Junction-to-Ambient ($t < 10s$) ⑥	—	31	

ORDERING INFORMATION:

See detailed ordering and shipping information on the last page of this data sheet.

Notes ① through ⑥ are on page 10

www.irf.com

Static @ T_J = 25°C (unless otherwise specified)

	Parameter	Min.	Typ.	Max.	Units	Conditions
BV _{DSS}	Drain-to-Source Breakdown Voltage	30	—	—	V	V _{GS} = 0V, I _D = 250μA
ΔBV _{DSS} /ΔT _J	Breakdown Voltage Temp. Coefficient	—	0.02	—	V/°C	Reference to 25°C, I _D = 1mA
R _{DS(on)}	Static Drain-to-Source On-Resistance	—	9.4	12.4	mΩ	V _{GS} = 10V, I _D = 12A ③
		—	14.5	17.9		V _{GS} = 4.5V, I _D = 9.4A ③
V _{GS(th)}	Gate Threshold Voltage	1.35	1.8	2.35	V	V _{DS} = V _{GS} , I _D = 25μA
ΔV _{GS(th)}	Gate Threshold Voltage Coefficient	—	-6.2	—	mV/°C	
I _{DSS}	Drain-to-Source Leakage Current	—	—	1.0	μA	V _{DS} = 24V, V _{GS} = 0V
		—	—	150		V _{DS} = 24V, V _{GS} = 0V, T _J = 125°C
I _{GSS}	Gate-to-Source Forward Leakage	—	—	100	nA	V _{GS} = 20V
	Gate-to-Source Reverse Leakage	—	—	-100		V _{GS} = -20V
gfs	Forward Transconductance	17	—	—	S	V _{DS} = 15V, I _D = 9.4A
Q _g	Total Gate Charge	—	5.4	8.1	nC	V _{DS} = 15V V _{GS} = 4.5V I _D = 9.4A See Fig.17 & 18
Q _{gs1}	Pre-V _{th} Gate-to-Source Charge	—	1.1	—		
Q _{gs2}	Post-V _{th} Gate-to-Source Charge	—	0.7	—		
Q _{gd}	Gate-to-Drain Charge	—	2.2	—		
Q _{godr}	Gate Charge Overdrive	—	1.5	—		
Q _{sw}	Switch Charge (Q _{gs2} + Q _{gd})	—	2.9	—		
Q _{oss}	Output Charge	—	3.8	—	nC	V _{DS} = 16V, V _{GS} = 0V
R _G	Gate Resistance	—	2.0	—	Ω	
t _{d(on)}	Turn-On Delay Time	—	9.0	—	ns	V _{DD} = 15V, V _{GS} = 4.5V I _D = 9.4A R _G = 1.3Ω See Fig.15
t _r	Rise Time	—	11	—		
t _{d(off)}	Turn-Off Delay Time	—	9.9	—		
t _f	Fall Time	—	5.6	—		
C _{iss}	Input Capacitance	—	755	—	pF	V _{GS} = 0V V _{DS} = 15V f = 1.0MHz
C _{oss}	Output Capacitance	—	171	—		
C _{rss}	Reverse Transfer Capacitance	—	83	—		

Avalanche Characteristics

	Parameter	Typ.	Max.	Units
E _{AS}	Single Pulse Avalanche Energy ②	—	13	mJ
I _{AR}	Avalanche Current ①	—	9.4	A

Diode Characteristics

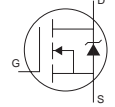
	Parameter	Min.	Typ.	Max.	Units	Conditions
I _S	Continuous Source Current (Body Diode)	—	—	3.5	A	MOSFET symbol showing the integral reverse p-n junction diode. 
I _{SM}	Pulsed Source Current (Body Diode) ①	—	—	96		
V _{SD}	Diode Forward Voltage	—	—	1.0	V	T _J = 25°C, I _S = 9.4A, V _{GS} = 0V ③
t _{rr}	Reverse Recovery Time	—	20	30	ns	T _J = 25°C, I _F = 9.4A, V _{DD} = 15V
Q _{rr}	Reverse Recovery Charge	—	27	41	nC	di/dt = 200A/μs ③
t _{on}	Forward Turn-On Time	Intrinsic turn-on time is negligible (turn-on is dominated by LS+LD)				

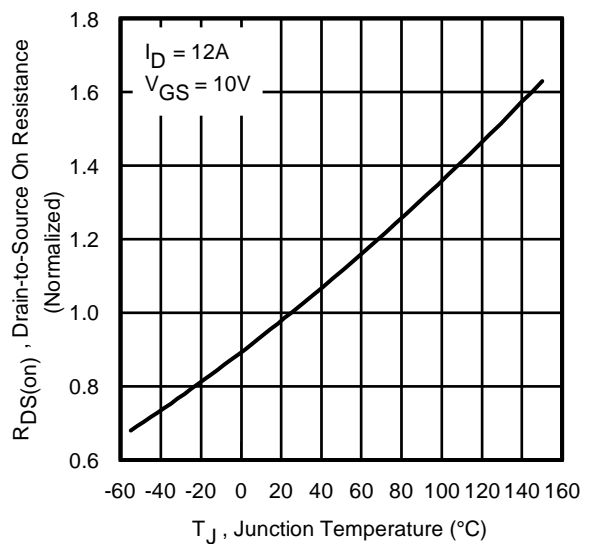
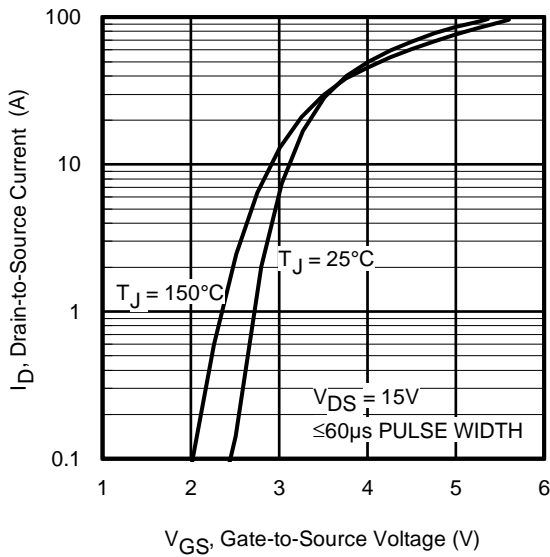
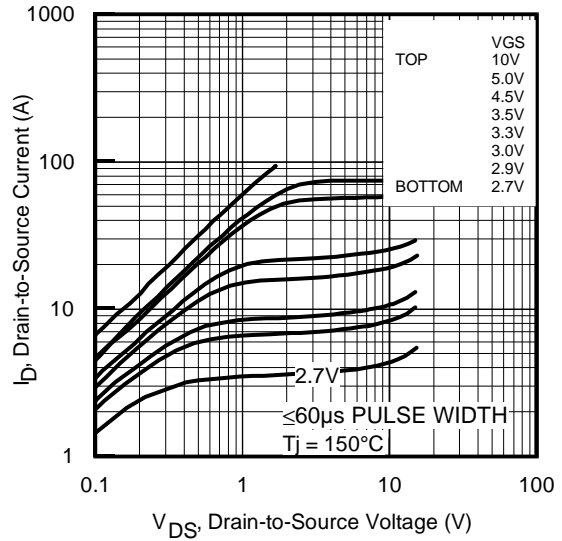
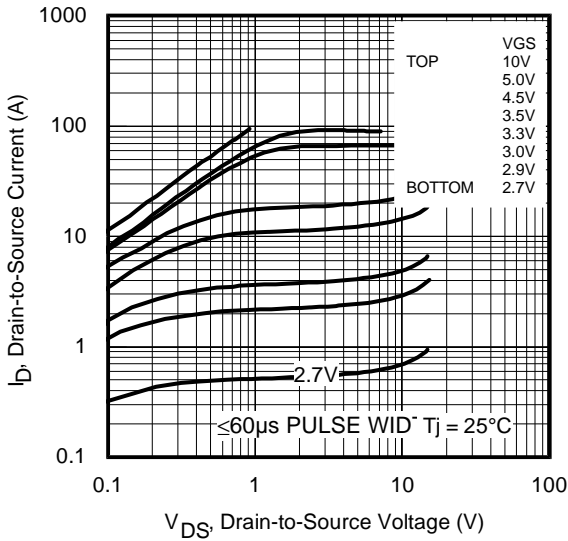

IRFH3707PbF

International
IR Rectifier

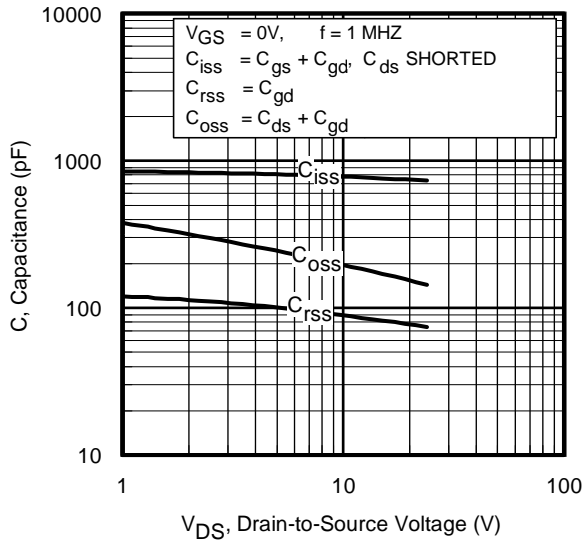

Fig 5. Typical Capacitance Vs. Drain-to-Source Voltage

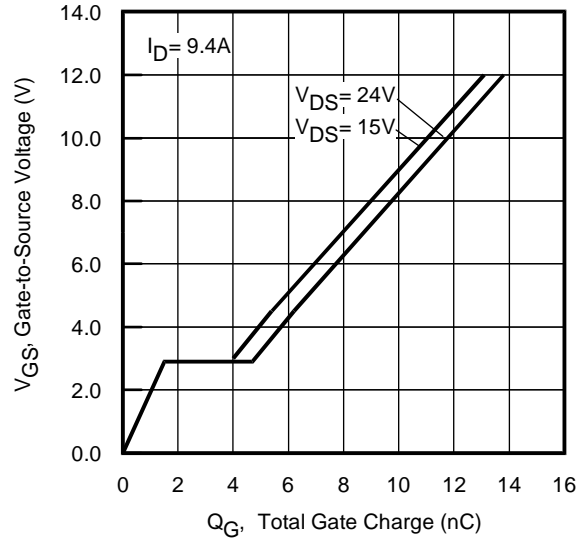

Fig 6. Typical Gate Charge Vs. Gate-to-Source Voltage

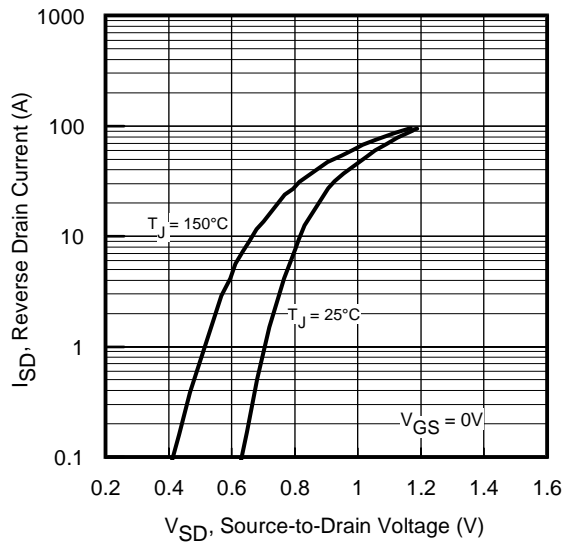

Fig 7. Typical Source-Drain Diode Forward Voltage

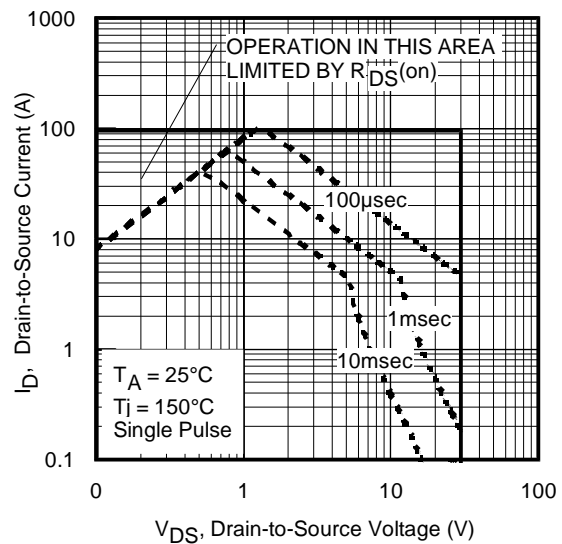

Fig 8. Maximum Safe Operating Area

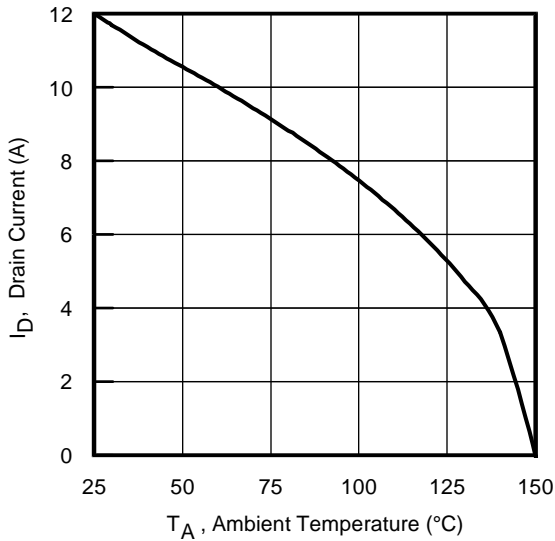

Fig 9. Maximum Drain Current Vs. Ambient Temperature

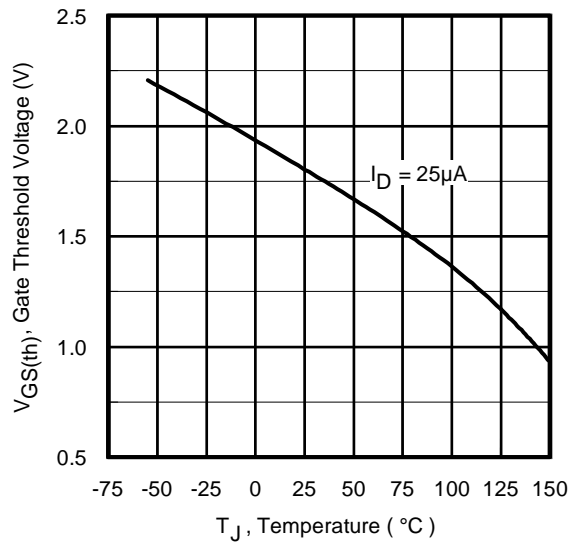

Fig 10. Threshold Voltage Vs. Temperature

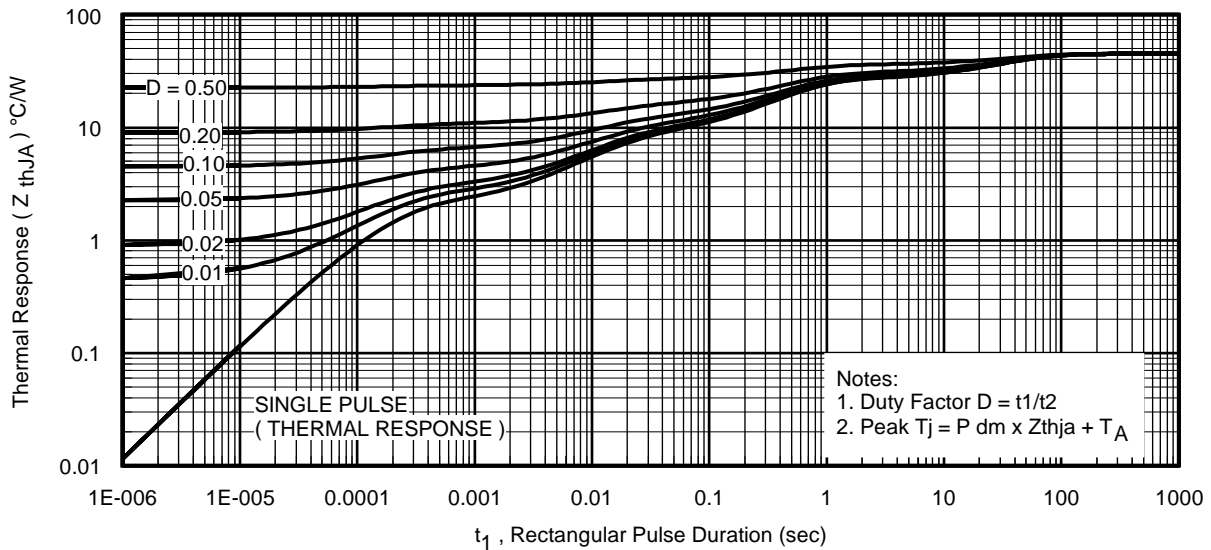

Fig 11. Maximum Effective Transient Thermal Impedance, Junction-to-Ambient

IRFH3707PbF

International
IR Rectifier

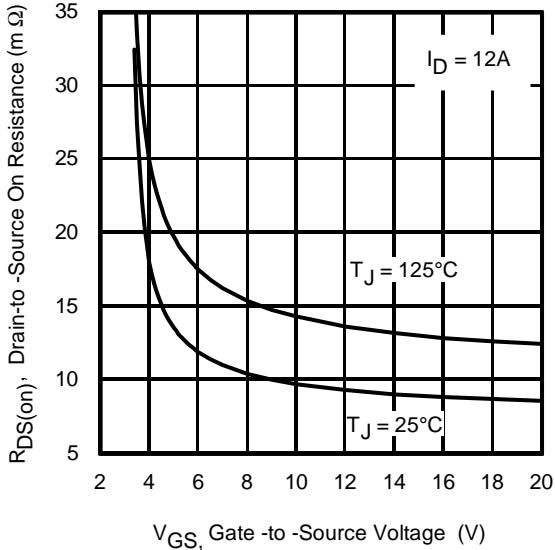

Fig 12. On-Resistance vs. Gate Voltage

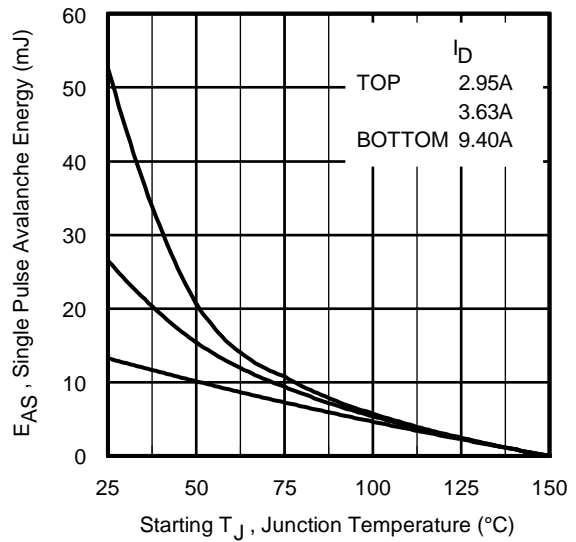

Fig 13. Maximum Avalanche Energy vs. Drain Current

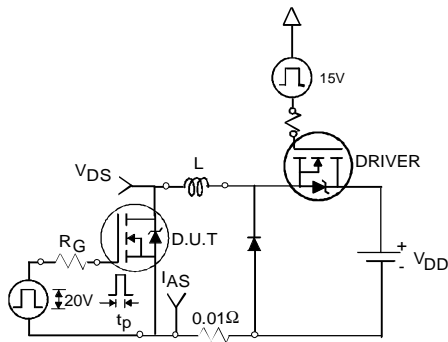

Fig 14a. Unclamped Inductive Test Circuit

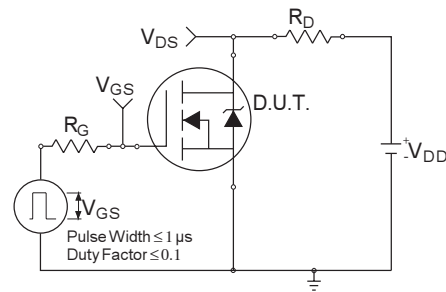

Fig 15a. Switching Time Test Circuit

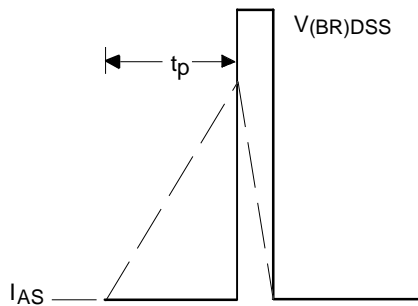

Fig 14b. Unclamped Inductive Waveforms

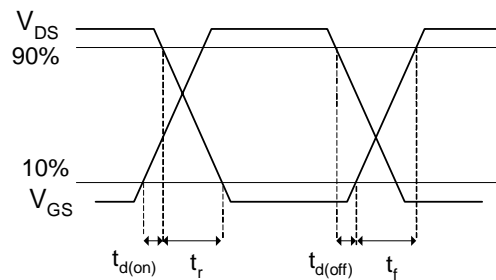
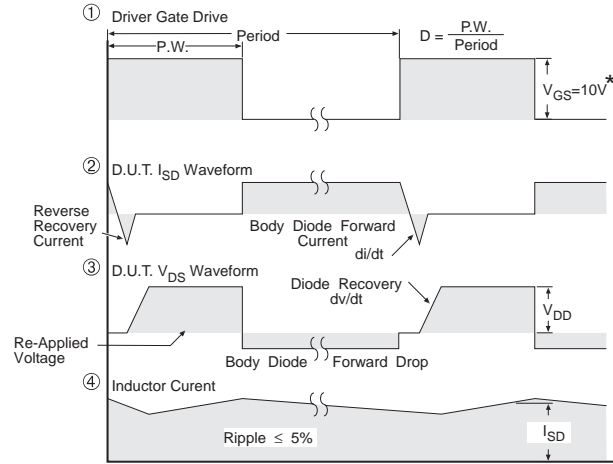
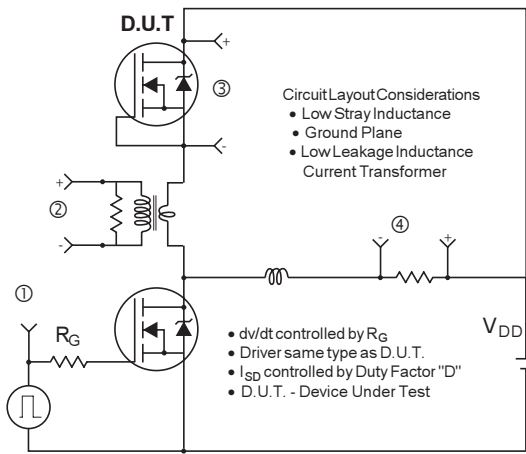

Fig 15b. Switching Time Waveforms



* $V_{GS} = 5V$ for Logic Level Devices

Fig 16. Peak Diode Recovery dv/dt Test Circuit for N-Channel HEXFET® Power MOSFETs

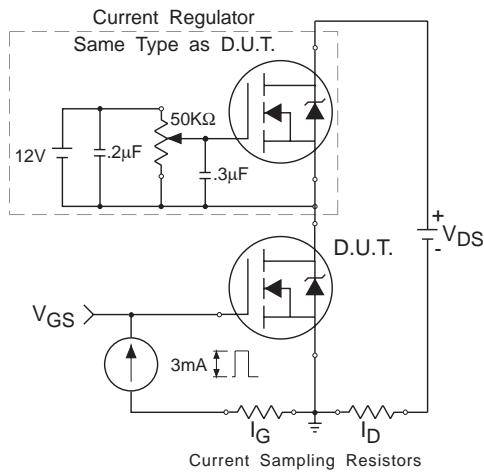

Fig 17. Gate Charge Test Circuit

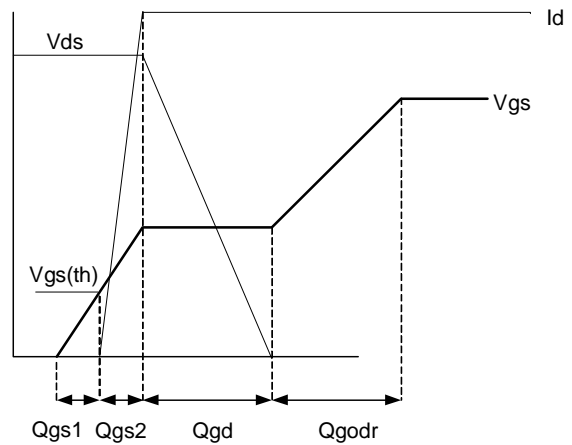
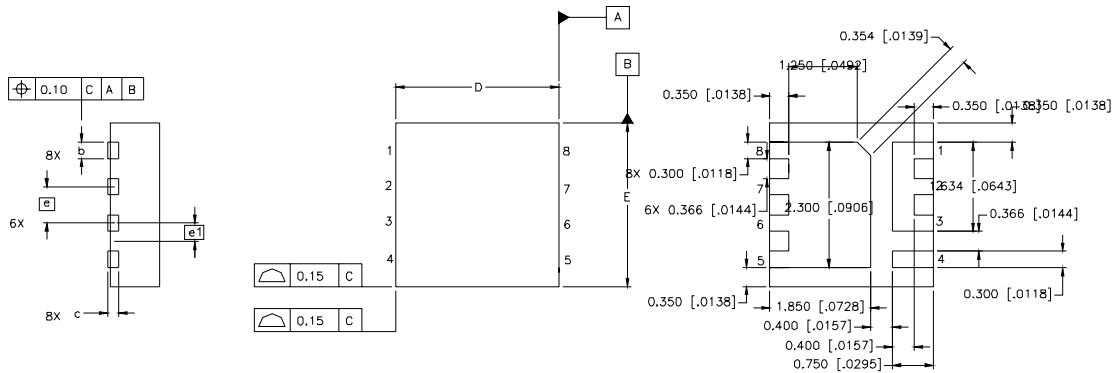

Fig 18. Gate Charge Waveform

IRFH3707PbF

PQFN Package Details



SIDE VIEW

TOP VIEW

BOTTOM VIEW

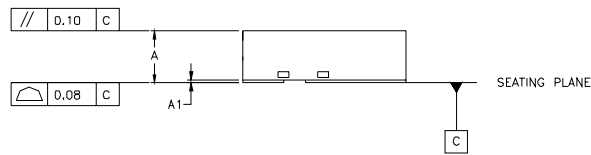

FRONT VIEW

DIM	INCHES		MILLIMETERS	
	MIN	MAX	MIN	MAX
A	.0315	.0394	0.800	1.000
A1	.0000	.0020	0.000	0.050
b	.0098	.0138	0.250	0.350
c	.0080 REF.		0.203 REF.	
D	.1181 BASIC		3.000 BASIC	
E	.1181 BASIC		3.000 BASIC	
e	.0262 BASIC		0.666 BASIC	
e1	.0131 BASIC		0.333 BASIC	

Note: For the most current drawing please refer to IR website at: <http://www.irf.com/package/>

PQFN Part Marking

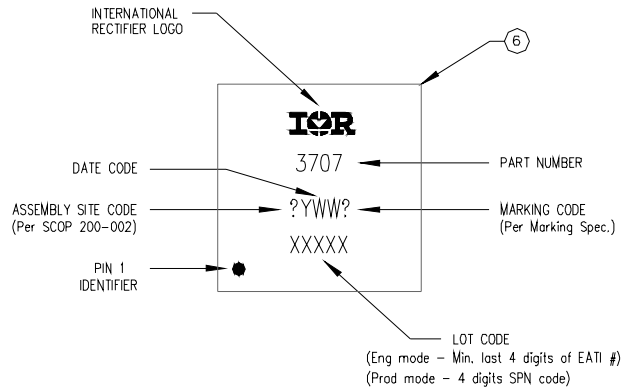

TOP MARKING (LASER)

PQFN Tape and Reel

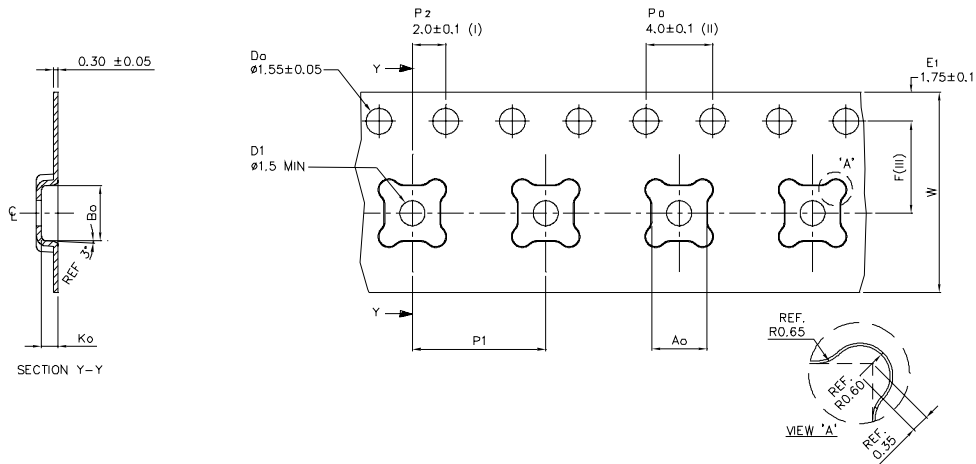

Ao	3.30 +/- 0.1
Bo	3.30 +/- 0.1
Ko	1.00 +/- 0.1
F	5.50 +/- 0.1
P1	8.00 +/- 0.1
W	12.00 +/- 0.3

- (I) Measured from centreline of sprocket hole to centreline of packet.
 - (II) Cumulative tolerance of 10 sprocket holes is ± 0.20 .
 - (III) Measured from centreline of sprocket hole to centreline of packet.
 - (IV) Other material available.
- ALL DIMENSIONS IN MILLIMETRES UNLESS OTHERWISE STATED.

Note: For the most current drawing please refer to IR website at: <http://www.irf.com/package/>
www.irf.com

IRFH3707PbF

International
IR Rectifier

Orderable part number	Package Type	Standard Pack		Note
		Form	Quantity	
IRFH3707TRPBF	PQFN 3mm x 3mm	Tape and Reel	4000	

Qualification information[†]

Qualification level	Consumer ^{††} (per JEDEC JESD47F ^{†††} guidelines)		
Moisture Sensitivity Level	PQFN 3mm x 3mm	MSL1 (per IPC/JEDEC J-STD-020D ^{†††})	
RoHS compliant	Yes		

† Qualification standards can be found at International Rectifier's web site

<http://www.irf.com/product-info/reliability>

†† Higher qualification ratings may be available should the user have such requirements.

Please contact your International Rectifier sales representative for further information:

<http://www.irf.com/whoto-call/salesrep/>

††† Applicable version of JEDEC standard at the time of product release.

Note: For the most current drawing please refer to IR website at: <http://www.irf.com/package/>

Notes:

- ① Repetitive rating; pulse width limited by max. junction temperature.
- ② Starting $T_J = 25^\circ\text{C}$, $L = 0.297\text{mH}$, $R_G = 25\Omega$, $I_{AS} = 9.4\text{A}$.
- ③ Pulse width $\leq 400\mu\text{s}$; duty cycle $\leq 2\%$.
- ④ R_{thjc} is guaranteed by design.
- ⑤ When mounted on 1 inch square 2 oz copper pad on 1.5x1.5 in. board of FR-4 material.
- ⑥ Refer to [application note #AN-994](#).

Data and specifications subject to change without notice

International
IR Rectifier

IR WORLD HEADQUARTERS: 233 Kansas St., El Segundo, California 90245, USA Tel: (310) 252-7105
TAC Fax: (310) 252-7903

Visit us at www.irf.com for sales contact information.02/2010