

# IRFH3702PbF

HEXFET® Power MOSFET

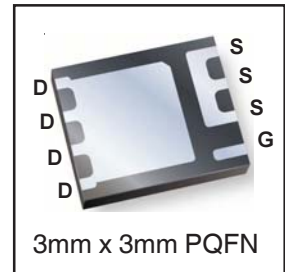
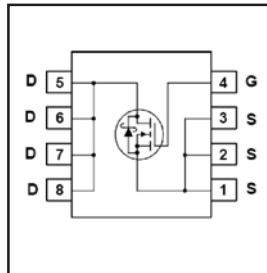
## Applications

- Synchronous Buck Converter for Computer Processor Power
- Isolated DC to DC Converters for Network and Telecom
- Buck Converters for Set-Top Boxes

$V_{DS}$	$R_{DS(on)}$ max	Qg
30V	7.1m $\Omega$ @ $V_{GS} = 10V$	9.6nC

## Benefits

- Low  $R_{DS(ON)}$
- Very Low Gate Charge
- Low Junction to PCB Thermal Resistance
- Fully Characterized Avalanche Voltage and Current
- 100% Tested for  $R_G$
- Lead-Free (Qualified up to 260°C Reflow)
- RoHS compliant (Halogen Free)



## Absolute Maximum Ratings

	Parameter	Max.	Units
$V_{DS}$	Drain-to-Source Voltage	30	V
$V_{GS}$	Gate-to-Source Voltage	$\pm 20$	
$I_D @ T_A = 25^\circ C$	Continuous Drain Current, $V_{GS} @ 10V$	16	A
$I_D @ T_A = 70^\circ C$	Continuous Drain Current, $V_{GS} @ 10V$	12	
$I_D @ T_C = 25^\circ C$	Continuous Drain Current, $V_{GS} @ 10V$	42	
$I_{DM}$	Pulsed Drain Current ①	120	
$P_D @ T_A = 25^\circ C$	Power Dissipation	2.8	W
$P_D @ T_A = 70^\circ C$	Power Dissipation	1.8	
	Linear Derating Factor	0.02	W/°C
$T_J$	Operating Junction and	-55 to + 150	°C
$T_{STG}$	Storage Temperature Range		

## Thermal Resistance

	Parameter	Typ.	Max.	Units
$R_{\theta JC}$	Junction-to-Case ④	—	6.0	°C/W
$R_{\theta JA}$	Junction-to-Ambient ⑤ ⑥	—	45	
$R_{\theta JA}$	Junction-to-Ambient ( $t < 10s$ ) ⑥	—	44	

### ORDERING INFORMATION:

See detailed ordering and shipping information on the last page of this data sheet.

Notes ① through ⑥ are on page 10

## Static @ $T_J = 25^\circ\text{C}$ (unless otherwise specified)

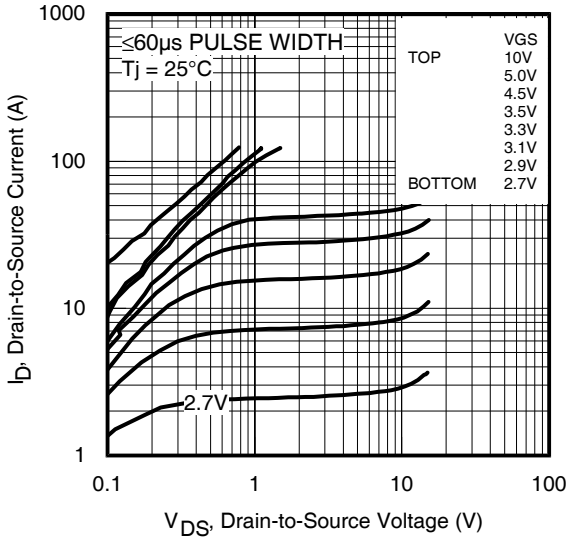
	Parameter	Min.	Typ.	Max.	Units	Conditions
$BV_{DSS}$	Drain-to-Source Breakdown Voltage	30	—	—	V	$V_{GS} = 0V, I_D = 250\mu A$
$\Delta BV_{DSS}/\Delta T_J$	Breakdown Voltage Temp. Coefficient	—	0.02	—	V/°C	Reference to $25^\circ\text{C}, I_D = 1mA$
$R_{DS(on)}$	Static Drain-to-Source On-Resistance	—	5.7	7.1	m $\Omega$	$V_{GS} = 10V, I_D = 16A$ ③
		—	8.7	11.8		$V_{GS} = 4.5V, I_D = 12A$ ③
$V_{GS(th)}$	Gate Threshold Voltage	1.35	1.8	2.35	V	$V_{DS} = V_{GS}, I_D = 25\mu A$
$\Delta V_{GS(th)}$	Gate Threshold Voltage Coefficient	—	-6.5	—	mV/°C	
$I_{DSS}$	Drain-to-Source Leakage Current	—	—	1.0	$\mu A$	$V_{DS} = 24V, V_{GS} = 0V$
		—	—	150		$V_{DS} = 24V, V_{GS} = 0V, T_J = 125^\circ\text{C}$
$I_{GSS}$	Gate-to-Source Forward Leakage	—	—	100	nA	$V_{GS} = 20V$
	Gate-to-Source Reverse Leakage	—	—	-100		$V_{GS} = -20V$
$g_{fs}$	Forward Transconductance	37	—	—	S	$V_{DS} = 15V, I_D = 12A$
$Q_g$	Total Gate Charge	—	9.6	14	nC	$V_{DS} = 15V$ $V_{GS} = 4.5V$ $I_D = 12A$ See Fig.17 & 18
$Q_{gs1}$	Pre-V <sub>th</sub> Gate-to-Source Charge	—	2.4	—		
$Q_{gs2}$	Post-V <sub>th</sub> Gate-to-Source Charge	—	1.2	—		
$Q_{gd}$	Gate-to-Drain Charge	—	3.1	—		
$Q_{godr}$	Gate Charge Overdrive	—	2.9	—		
$Q_{sw}$	Switch Charge ( $Q_{gs2} + Q_{gd}$ )	—	4.3	—		
$Q_{oss}$	Output Charge	—	7.4	—	nC	$V_{DS} = 16V, V_{GS} = 0V$
$R_G$	Gate Resistance	—	2.2	—	$\Omega$	
$t_{d(on)}$	Turn-On Delay Time	—	9.6	—	ns	$V_{DD} = 15V, V_{GS} = 4.5V$ $I_D = 12A$ $R_G = 1.8\Omega$ See Fig.15
$t_r$	Rise Time	—	15	—		
$t_{d(off)}$	Turn-Off Delay Time	—	11	—		
$t_f$	Fall Time	—	5.8	—		
$C_{iss}$	Input Capacitance	—	1510	—	pF	$V_{GS} = 0V$ $V_{DS} = 15V$ $f = 1.0MHz$
$C_{oss}$	Output Capacitance	—	306	—		
$C_{rss}$	Reverse Transfer Capacitance	—	120	—		

## Avalanche Characteristics

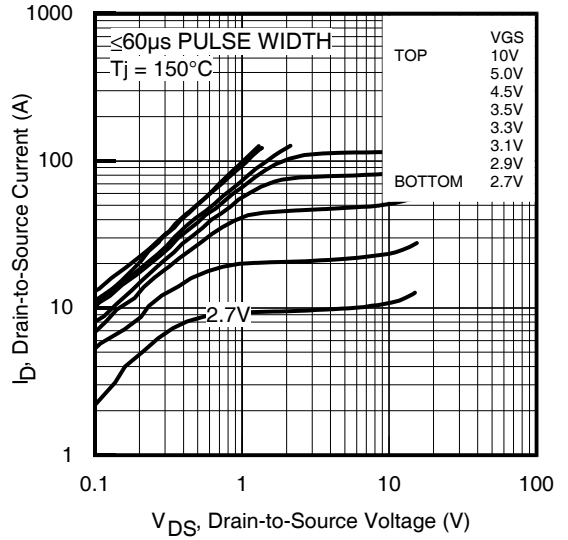
	Parameter	Typ.	Max.	Units
$E_{AS}$	Single Pulse Avalanche Energy ②	—	77	mJ
$I_{AR}$	Avalanche Current ①	—	12	A

## Diode Characteristics

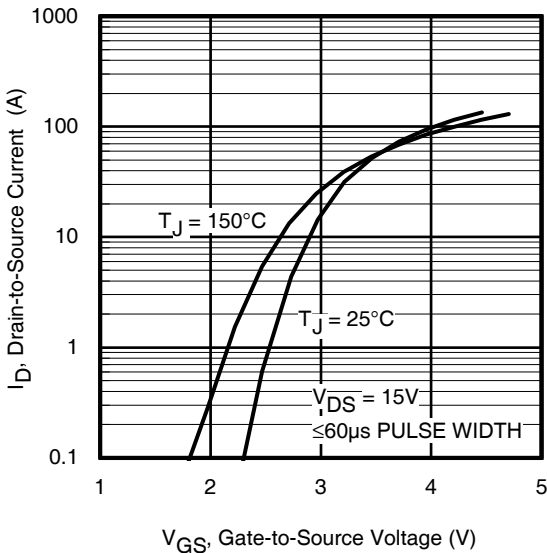
	Parameter	Min.	Typ.	Max.	Units	Conditions
$I_S$	Continuous Source Current (Body Diode)	—	—	3.5	A	MOSFET symbol showing the integral reverse p-n junction diode.
$I_{SM}$	Pulsed Source Current (Body Diode) ①	—	—	120		
$V_{SD}$	Diode Forward Voltage	—	—	1.0	V	$T_J = 25^\circ\text{C}, I_S = 12A, V_{GS} = 0V$ ③
$t_{rr}$	Reverse Recovery Time	—	17	26	ns	$T_J = 25^\circ\text{C}, I_F = 12A, V_{DD} = 15V$
$Q_{rr}$	Reverse Recovery Charge	—	15	23	nC	$di/dt = 225A/\mu s$ ③
$t_{on}$	Forward Turn-On Time	Intrinsic turn-on time is negligible (turn-on is dominated by LS+LD)				



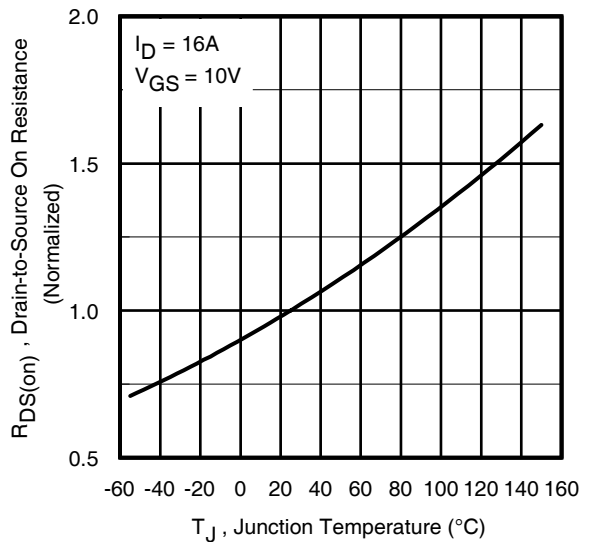
**Fig 1.** Typical Output Characteristics



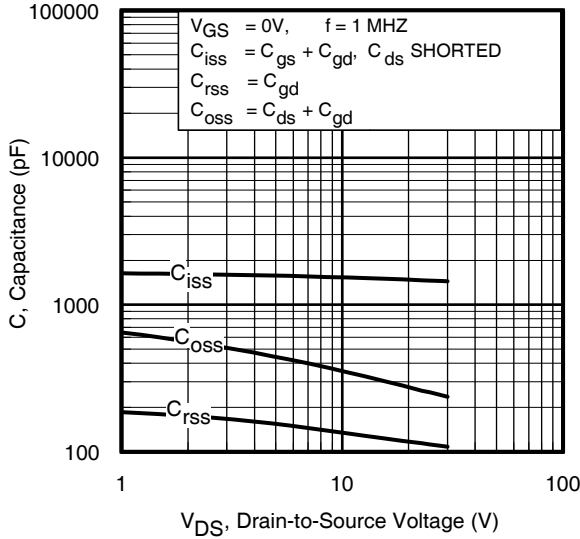
**Fig 2.** Typical Output Characteristics



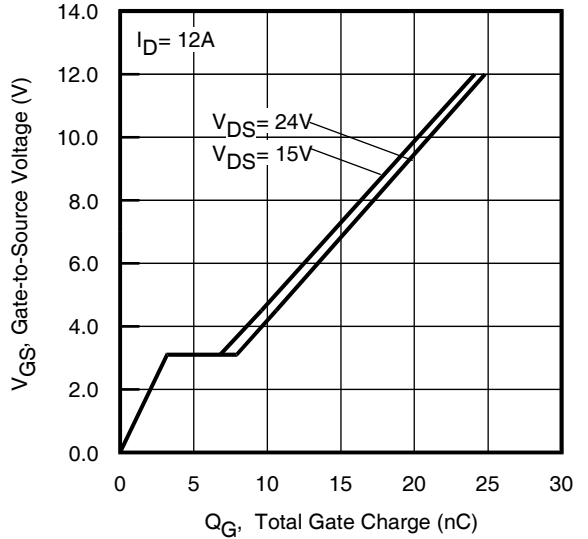
**Fig 3.** Typical Transfer Characteristics



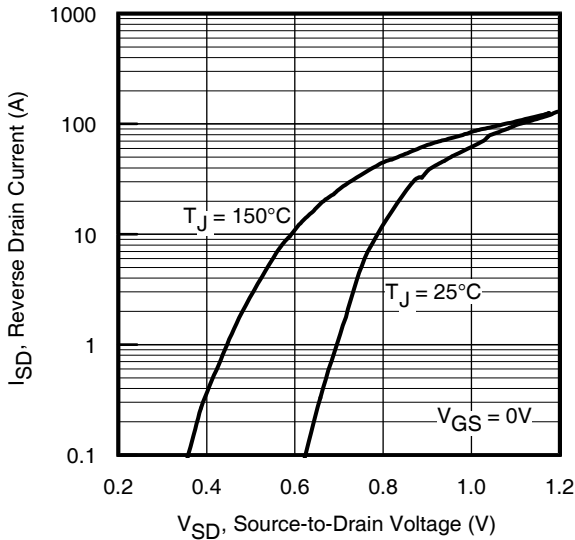
**Fig 4.** Normalized On-Resistance vs. Temperature



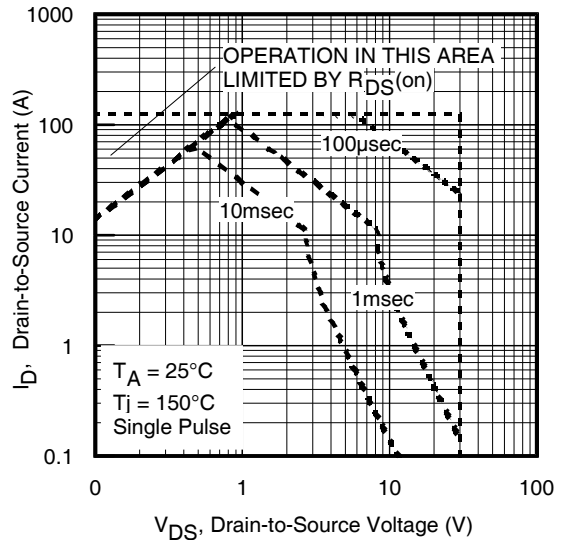
**Fig 5.** Typical Capacitance vs. Drain-to-Source Voltage



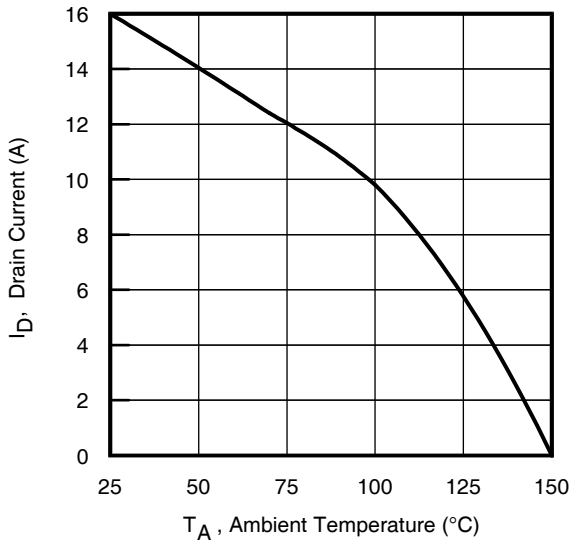
**Fig 6.** Typical Gate Charge vs. Gate-to-Source Voltage



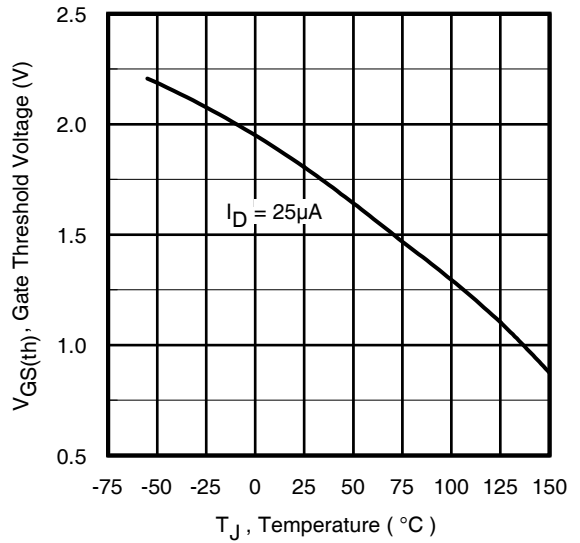
**Fig 7.** Typical Source-Drain Diode Forward Voltage



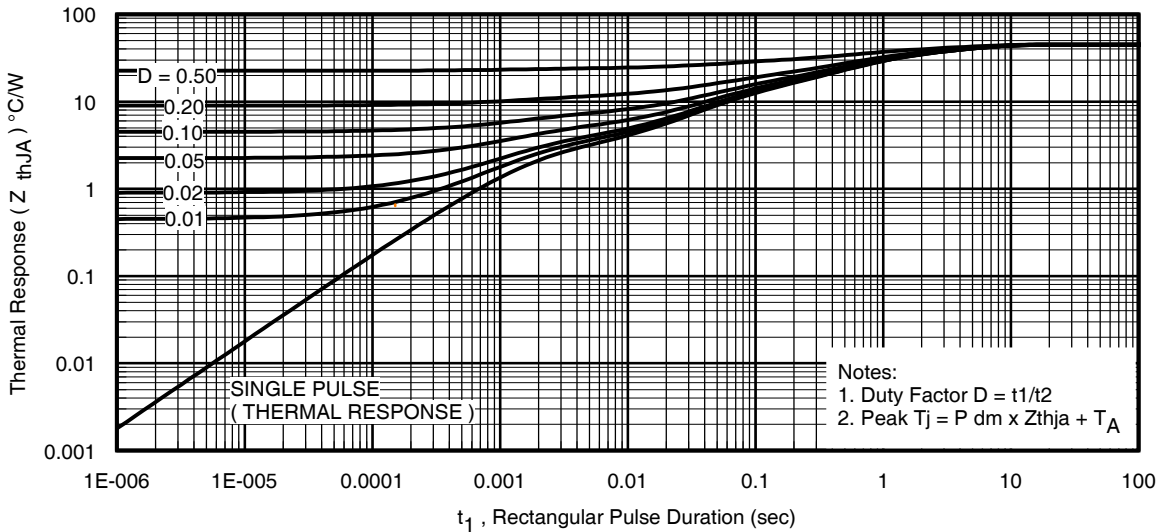
**Fig 8.** Maximum Safe Operating Area



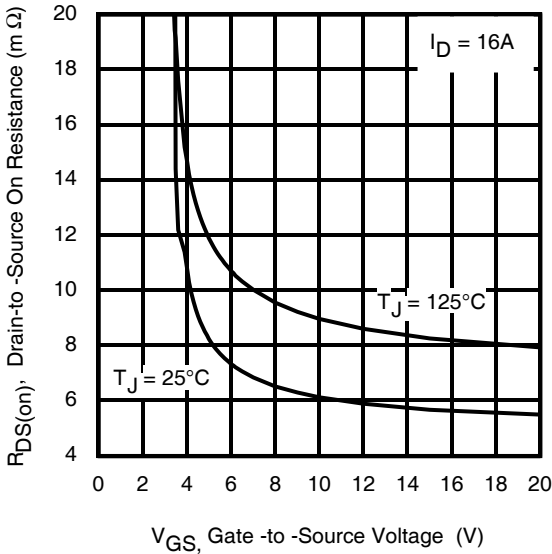
**Fig 9.** Maximum Drain Current vs. Ambient Temperature



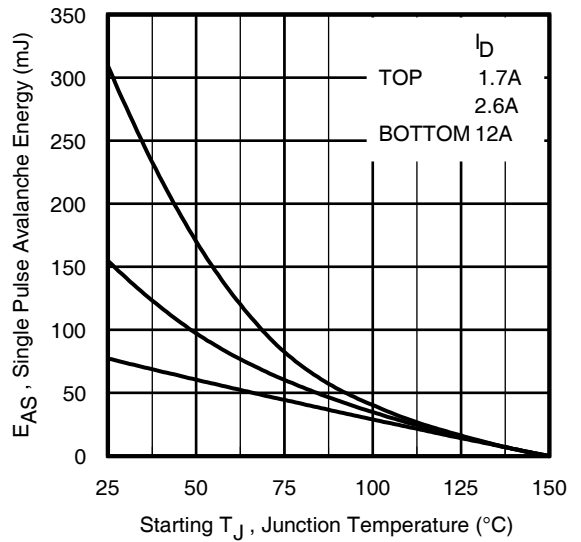
**Fig 10.** Threshold Voltage Vs. Temperature



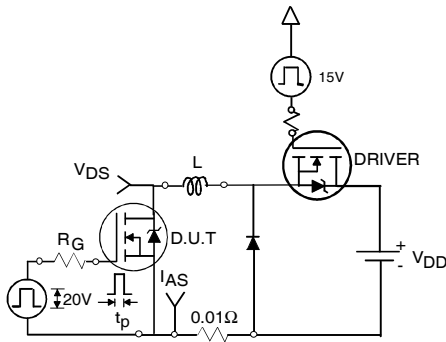
**Fig 11.** Maximum Effective Transient Thermal Impedance, Junction-to-Ambient



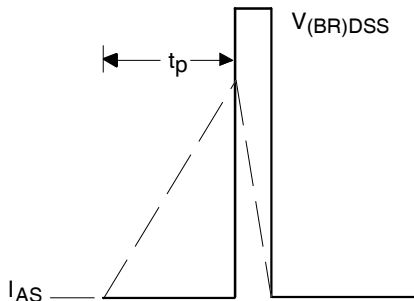
**Fig 12.** On-Resistance vs. Gate Voltage



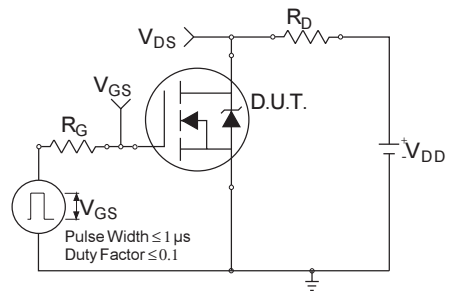
**Fig 13.** Maximum Avalanche Energy vs. Drain Current



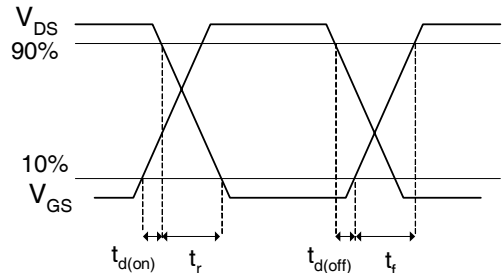
**Fig 14a.** Unclamped Inductive Test Circuit



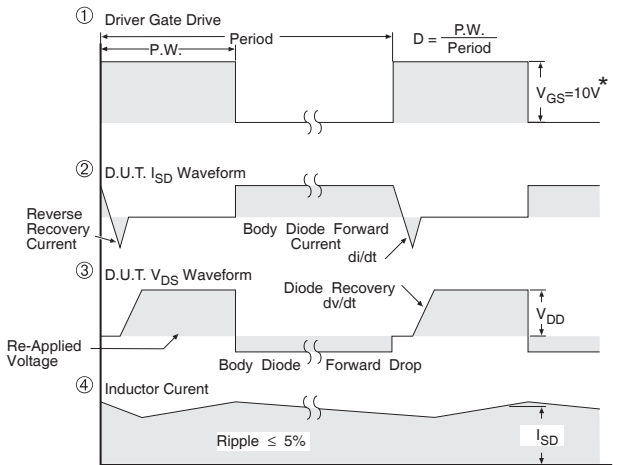
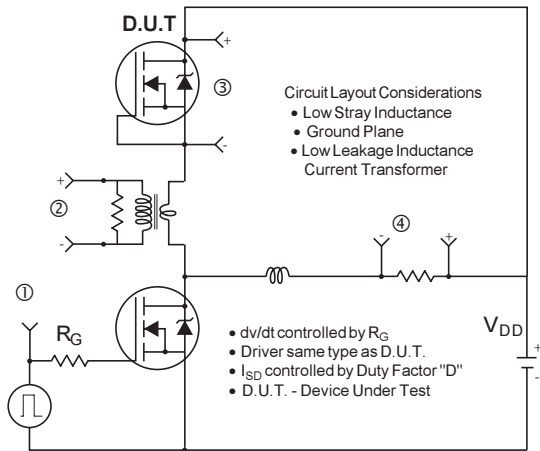
**Fig 14b.** Unclamped Inductive Waveforms



**Fig 15a.** Switching Time Test Circuit

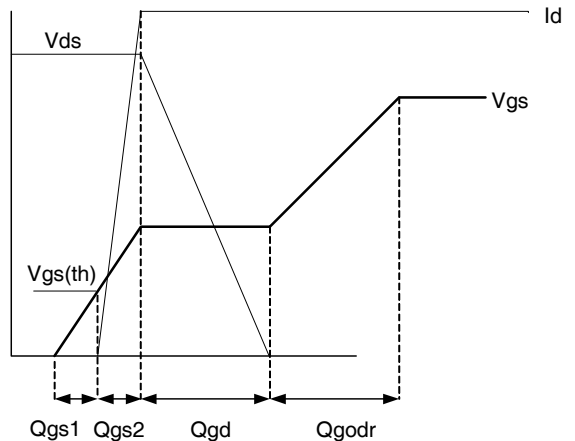
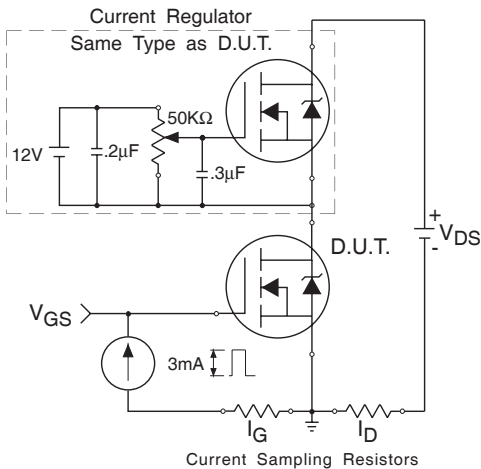


**Fig 15b.** Switching Time Waveforms



\*  $V_{GS} = 5V$  for Logic Level Devices

**Fig 16. Peak Diode Recovery  $dv/dt$  Test Circuit for N-Channel HEXFET® Power MOSFETs**

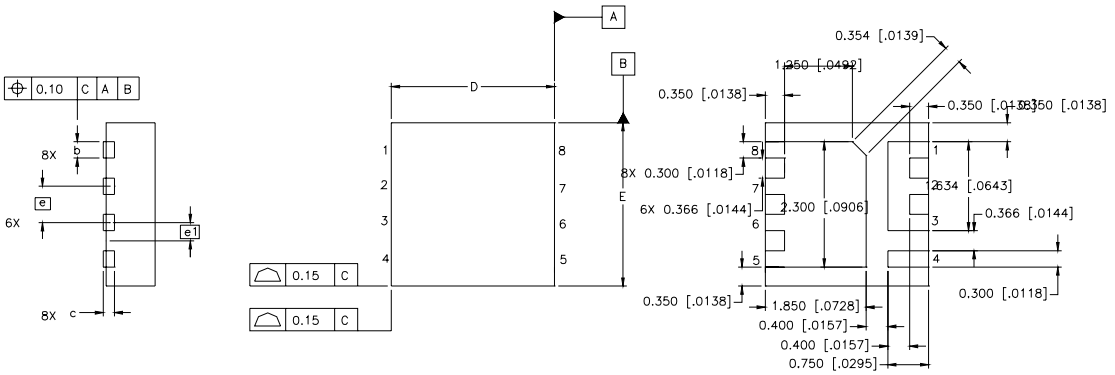


**Fig 17. Gate Charge Test Circuit**

**Fig 18. Gate Charge Waveform**

# IRFH3702PbF

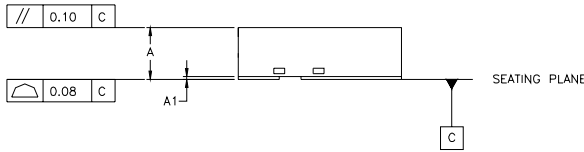
## PQFN Package Details



SIDE VIEW

TOP VIEW

BOTTOM VIEW



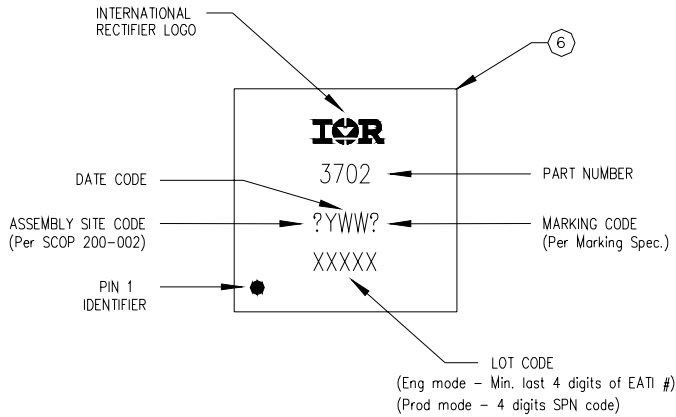
FRONT VIEW

DIM	INCHES		MILLIMETERS	
	MIN	MAX	MIN	MAX
A	.0315	.0394	0.800	1.000
A1	.0000	.0020	0.000	0.050
b	.0098	.0138	0.250	0.350
c	.0080 REF.		0.203 REF.	
D	.1181 BASIC		3.000 BASIC	
E	.1181 BASIC		3.000 BASIC	
e	.0262 BASIC		0.666 BASIC	
e1	.0131 BASIC		0.333 BASIC	

Note: For the most current drawing please refer to IR website at: <http://www.irf.com/package/>

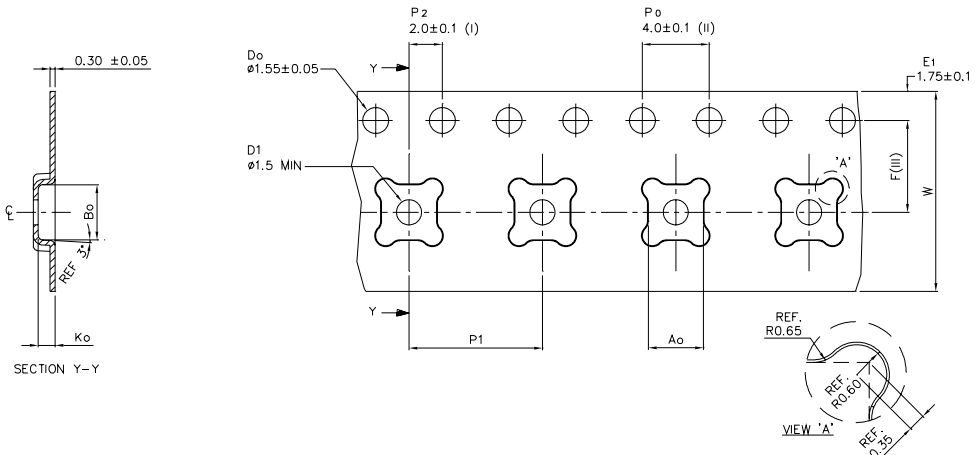


## PQFN Part Marking



TOP MARKING (LASER)

## PQFN Tape and Reel



A <sub>0</sub>	3.30	+/- 0.1
B <sub>0</sub>	3.30	+/- 0.1
K <sub>0</sub>	1.00	+/- 0.1
F	5.50	+/- 0.1
P <sub>1</sub>	8.00	+/- 0.1
W	12.00	+/- 0.3

- (I) Measured from centreline of sprocket hole to centreline of pocket.
- (II) Cumulative tolerance of 10 sprocket holes is  $\pm 0.20$ .
- (III) Measured from centreline of sprocket hole to centreline of pocket.
- (IV) Other material available.

ALL DIMENSIONS IN MILLIMETRES UNLESS OTHERWISE STATED.

Orderable part number	Package Type	Standard Pack		Note
		Form	Quantity	
IRFH3702TRPBF	PQFN 3mm x 3mm	Tape and Reel	4000	

### Qualification information<sup>†</sup>

Qualification level	Consumer <sup>††</sup> (per JEDEC JESD47F <sup>†††</sup> guidelines)		
Moisture Sensitivity Level	PQFN 3mm x 3mm	MSL1 (per IPC/JEDEC J-STD-020D <sup>†††</sup> )	
RoHS compliant	Yes		

† Qualification standards can be found at International Rectifier's web site

<http://www.irf.com/product-info/reliability>

†† Higher qualification ratings may be available should the user have such requirements.

Please contact your International Rectifier sales representative for further information:

<http://www.irf.com/whoto-call/salesrep/>

††† Applicable version of JEDEC standard at the time of product release.

**Note:** For the most current drawing please refer to IR website at: <http://www.irf.com/package/>

#### Notes:

- ① Repetitive rating; pulse width limited by max. junction temperature.
- ② Starting  $T_J = 25^\circ\text{C}$ ,  $L = 1.0\text{mH}$ ,  $R_G = 25\Omega$ ,  $I_{AS} = 12\text{A}$ .
- ③ Pulse width  $\leq 400\mu\text{s}$ ; duty cycle  $\leq 2\%$ .
- ④ Rthjc is guaranteed by design.
- ⑤ When mounted on 1 inch square 2 oz copper pad on 1.5x1.5 in. board of FR-4 material.
- ⑥ Refer to [application note #AN-994](#).

Data and specifications subject to change without notice

International  
**IR** Rectifier

**IR WORLD HEADQUARTERS:** 233 Kansas St., El Segundo, California 90245, USA Tel: (310) 252-7105

TAC Fax: (310) 252-7903

Visit us at [www.irf.com](http://www.irf.com) for sales contact information.02/09