

# IRF9321PbF

HEXFET® Power MOSFET

$V_{DS}$	<b>-30</b>	<b>V</b>
$R_{DS(on) \max}$ (@ $V_{GS} = -10V$ )	<b>7.2</b>	<b>m<math>\Omega</math></b>
$R_{DS(on) \max}$ (@ $V_{GS} = -4.5V$ )	<b>11.2</b>	<b>m<math>\Omega</math></b>
$Q_g$ (typical)	<b>34</b>	<b>nC</b>
$I_D$ (@ $T_A = 25^\circ C$ )	<b>-15</b>	<b>A</b>

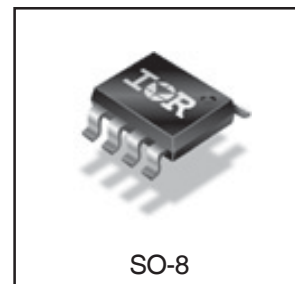
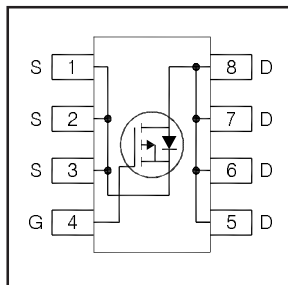

## Applications

- Charge and Discharge Switch for Notebook PC Battery Application

## Features and Benefits

### Features

Industry-Standard SO-8 Package
RoHS Compliant Containing no Lead, no Bromide and no Halogen

results in  
⇒

### Resulting Benefits

Multi-Vendor Compatibility
Environmentally Friendlier

Orderable part number	Package Type	Standard Pack		Note
		Form	Quantity	
IRF9321PbF	SO8	Tube/Bulk	95	
IRF9321TRPbF	SO8	Tape and Reel	4000	

## Absolute Maximum Ratings

	Parameter	Max.	Units
$V_{DS}$	Drain-to-Source Voltage	-30	V
$V_{GS}$	Gate-to-Source Voltage	±20	
$I_D @ T_A = 25^\circ C$	Continuous Drain Current, $V_{GS} @ -10V$	-15	A
$I_D @ T_A = 70^\circ C$	Continuous Drain Current, $V_{GS} @ -10V$	-12	
$I_{DM}$	Pulsed Drain Current ①	-120	
$P_D @ T_A = 25^\circ C$	Power Dissipation ④	2.5	W
$P_D @ T_A = 70^\circ C$	Power Dissipation ④	1.6	
	Linear Derating Factor	0.02	W/°C
$T_J$	Operating Junction and	-55 to + 150	°C
$T_{STG}$	Storage Temperature Range		

Notes ① through ⑥ are on page 2

## Static @ T<sub>J</sub> = 25°C (unless otherwise specified)

	Parameter	Min.	Typ.	Max.	Units	Conditions
BV <sub>DSS</sub>	Drain-to-Source Breakdown Voltage	-30	—	—	V	V <sub>GS</sub> = 0V, I <sub>D</sub> = -250μA
ΔBV <sub>DSS</sub> /ΔT <sub>J</sub>	Breakdown Voltage Temp. Coefficient	—	0.021	—	V/°C	Reference to 25°C, I <sub>D</sub> = -1mA
R <sub>DS(on)</sub>	Static Drain-to-Source On-Resistance	—	5.9	7.2	mΩ	V <sub>GS</sub> = -10V, I <sub>D</sub> = -15A ③
		—	9.3	11.2		V <sub>GS</sub> = -4.5V, I <sub>D</sub> = -12A ③
V <sub>GS(th)</sub>	Gate Threshold Voltage	-1.3	-1.8	-2.4	V	V <sub>DS</sub> = V <sub>GS</sub> , I <sub>D</sub> = -50μA
ΔV <sub>GS(th)</sub>	Gate Threshold Voltage Coefficient	—	-5.9	—	mV/°C	
I <sub>DSS</sub>	Drain-to-Source Leakage Current	—	—	-1.0	μA	V <sub>DS</sub> = -24V, V <sub>GS</sub> = 0V
		—	—	-150		V <sub>DS</sub> = -24V, V <sub>GS</sub> = 0V, T <sub>J</sub> = 125°C
I <sub>GSS</sub>	Gate-to-Source Forward Leakage	—	—	-100	nA	V <sub>GS</sub> = -20V
	Gate-to-Source Reverse Leakage	—	—	100		V <sub>GS</sub> = 20V
g <sub>fs</sub>	Forward Transconductance	30	—	—	S	V <sub>DS</sub> = -10V, I <sub>D</sub> = -12A
Q <sub>g</sub>	Total Gate Charge ⑥	—	34	—	nC	V <sub>DS</sub> = -15V, V <sub>GS</sub> = -4.5V, I <sub>D</sub> = -12A
Q <sub>g</sub>	Total Gate Charge ⑥	—	65	98	nC	V <sub>GS</sub> = -10V
Q <sub>gs</sub>	Gate-to-Source Charge ⑥	—	10	—		V <sub>DS</sub> = -15V
Q <sub>gd</sub>	Gate-to-Drain Charge ⑥	—	16	—		I <sub>D</sub> = -12A
R <sub>G</sub>	Gate Resistance ⑥	—	18	—	Ω	
t <sub>d(on)</sub>	Turn-On Delay Time	—	21	—	ns	V <sub>DD</sub> = -30V, V <sub>GS</sub> = -4.5V ③
t <sub>r</sub>	Rise Time	—	79	—		I <sub>D</sub> = -1.0A
t <sub>d(off)</sub>	Turn-Off Delay Time	—	185	—		R <sub>G</sub> = 6.8Ω
t <sub>f</sub>	Fall Time	—	145	—		See Figs. 19a & 19b
C <sub>iss</sub>	Input Capacitance	—	2590	—		V <sub>GS</sub> = 0V
C <sub>oss</sub>	Output Capacitance	—	590	—	pF	V <sub>DS</sub> = -25V
C <sub>rss</sub>	Reverse Transfer Capacitance	—	360	—		f = 1.0MHz

## Avalanche Characteristics

	Parameter	Typ.	Max.	Units
E <sub>AS</sub>	Single Pulse Avalanche Energy ②	—	310	mJ
I <sub>AR</sub>	Avalanche Current ①	—	-12	A

## Diode Characteristics

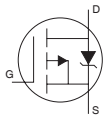
	Parameter	Min.	Typ.	Max.	Units	Conditions
I <sub>S</sub>	Continuous Source Current (Body Diode)	—	—	-2.5	A	MOSFET symbol showing the integral reverse p-n junction diode. 
I <sub>SM</sub>	Pulsed Source Current (Body Diode) ①	—	—	-120		
V <sub>SD</sub>	Diode Forward Voltage	—	—	-1.2	V	T <sub>J</sub> = 25°C, I <sub>S</sub> = -2.5A, V <sub>GS</sub> = 0V ③
t <sub>rr</sub>	Reverse Recovery Time	—	38	57	ns	T <sub>J</sub> = 25°C, I <sub>F</sub> = -2.5A, V <sub>DD</sub> = -24V
Q <sub>rr</sub>	Reverse Recovery Charge	—	24	36	nC	di/dt = 100/μs ③

## Thermal Resistance

	Parameter	Typ.	Max.	Units
R <sub>θJL</sub>	Junction-to-Drain Lead ⑤	—	20	°C/W
R <sub>θJA</sub>	Junction-to-Ambient ④	—	50	

### Notes:

- ① Repetitive rating; pulse width limited by max. junction temperature.
- ② Starting T<sub>J</sub> = 25°C, L = 4.3mH, R<sub>G</sub> = 25Ω, I<sub>AS</sub> = -12A.
- ③ Pulse width ≤ 400μs; duty cycle ≤ 2%.
- ④ When mounted on 1 inch square copper board.
- ⑤ R<sub>θ</sub> is measured at T<sub>J</sub> of approximately 90°C.
- ⑥ For DESIGN AID ONLY, not subject to production testing.

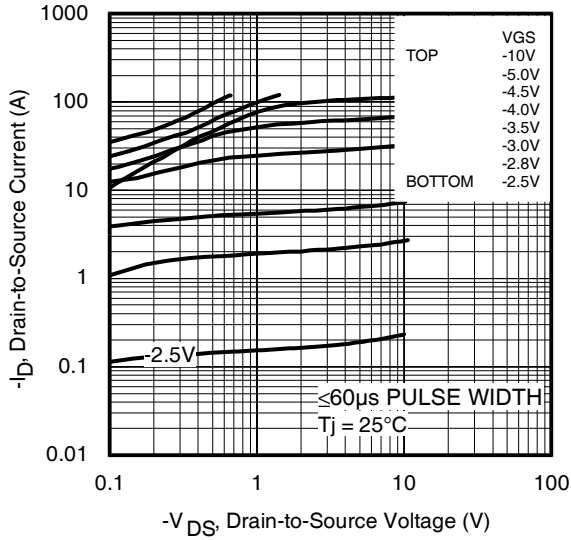

**Fig 1.** Typical Output Characteristics

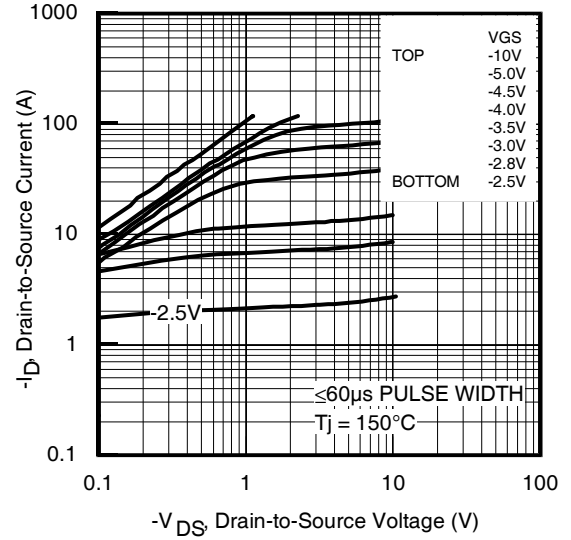

**Fig 2.** Typical Output Characteristics

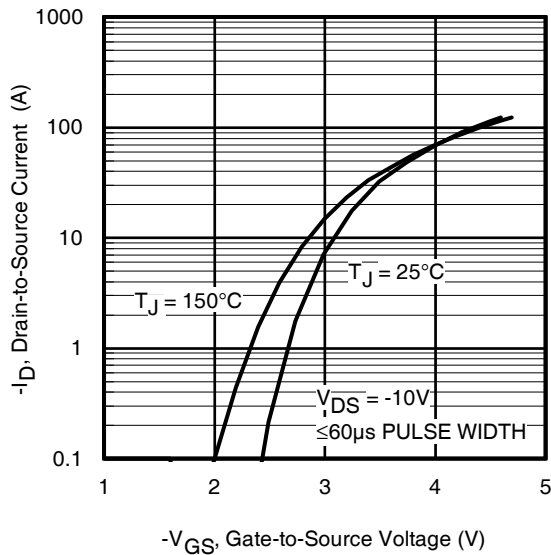

**Fig 3.** Typical Transfer Characteristics

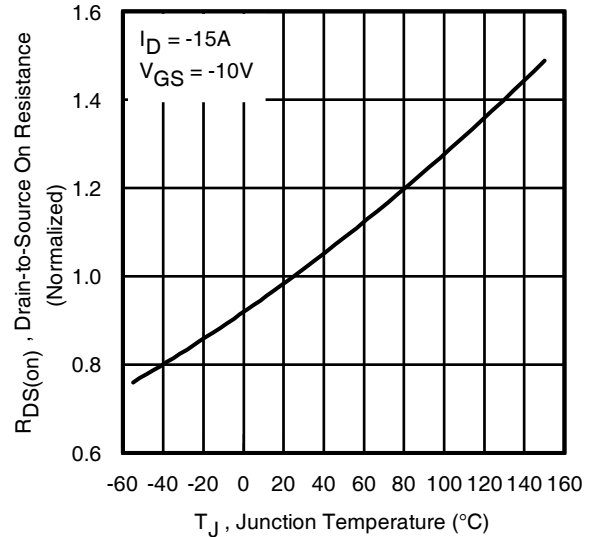

**Fig 4.** Normalized On-Resistance vs. Temperature

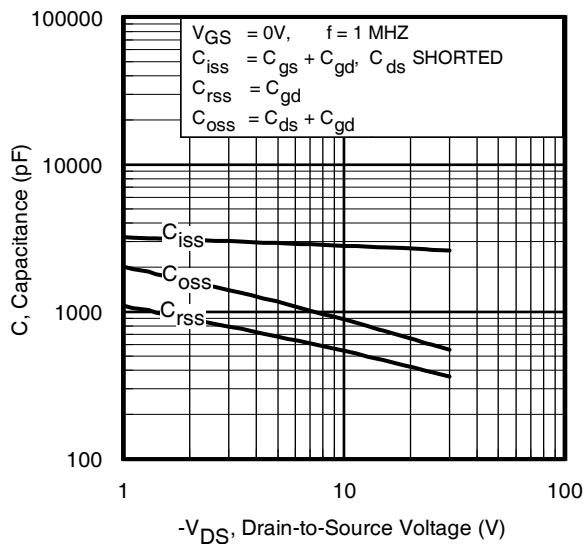

**Fig 5.** Typical Capacitance vs. Drain-to-Source Voltage  
[www.irf.com](http://www.irf.com)

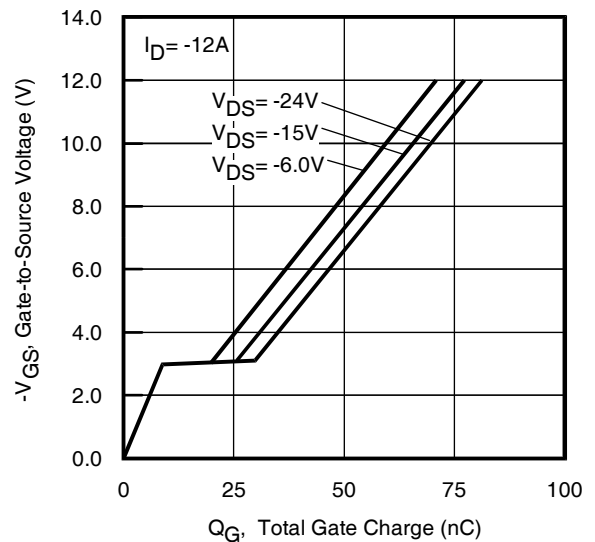

**Fig 6.** Typical Gate Charge vs. Gate-to-Source Voltage

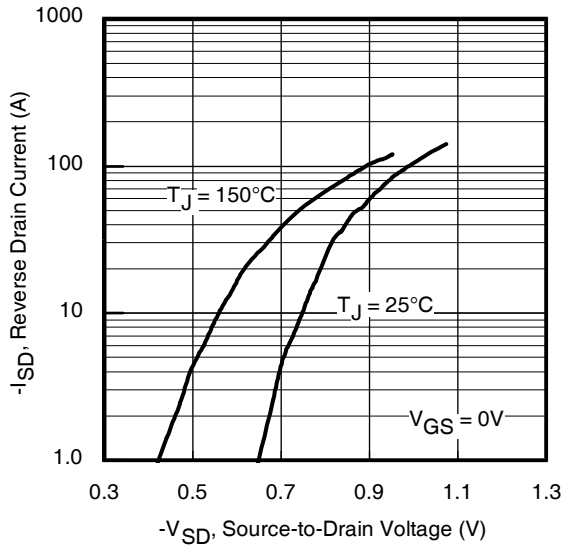

**Fig 7.** Typical Source-Drain Diode Forward Voltage

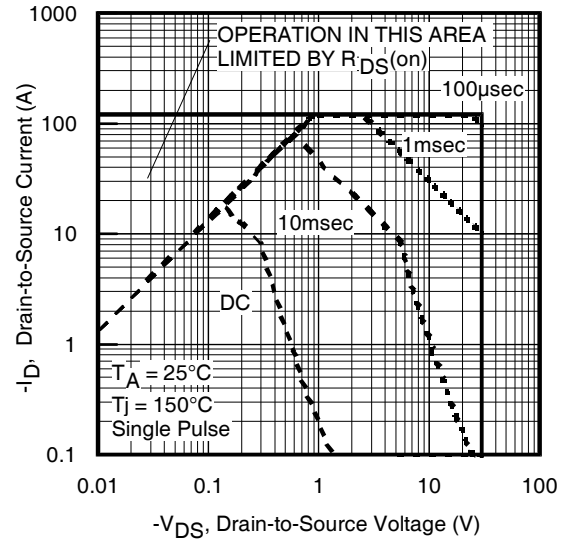

**Fig 8.** Maximum Safe Operating Area

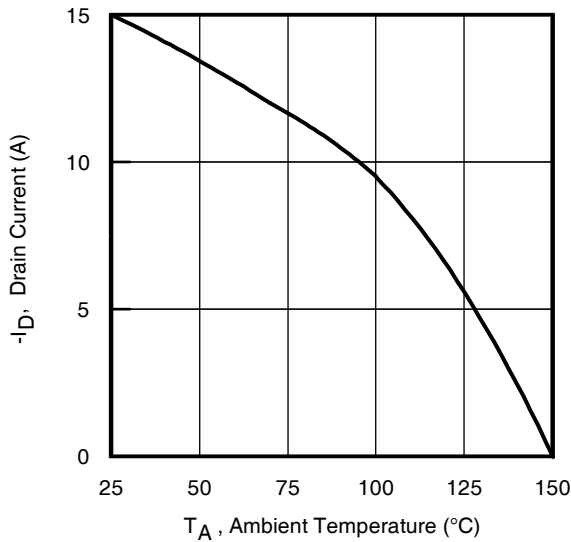

**Fig 9.** Maximum Drain Current vs. Ambient Temperature

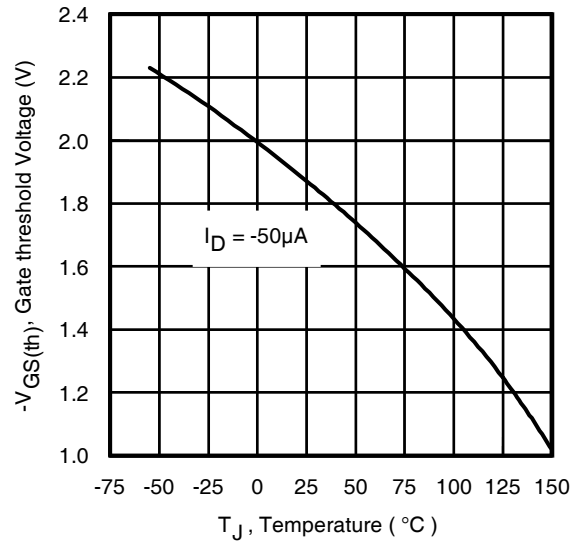

**Fig 10.** Threshold Voltage vs. Temperature

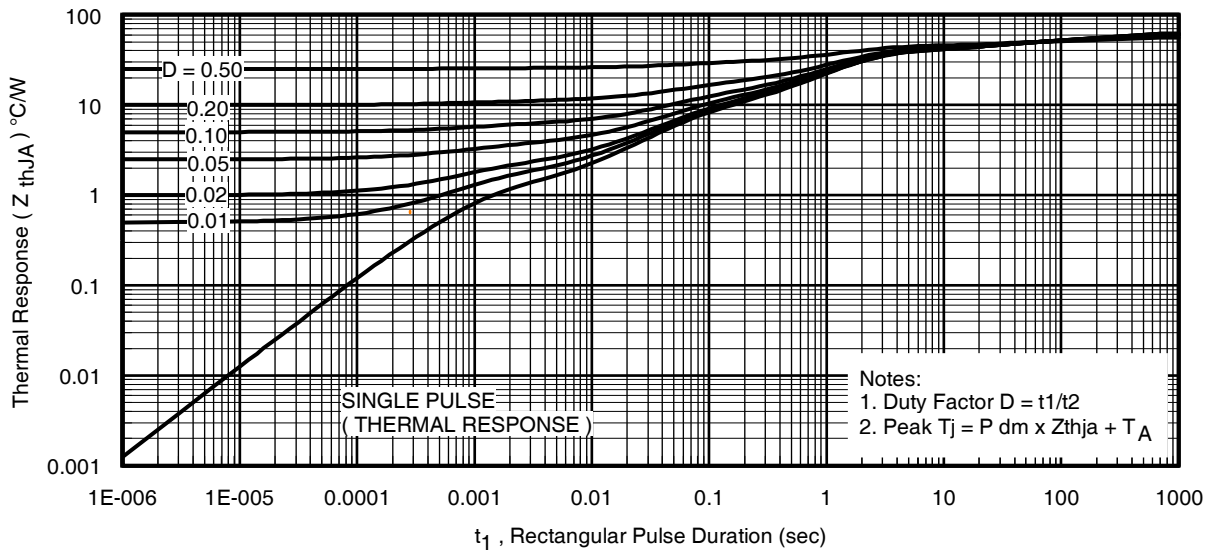

**Fig 11.** Maximum Effective Transient Thermal Impedance, Junction-to-Ambient

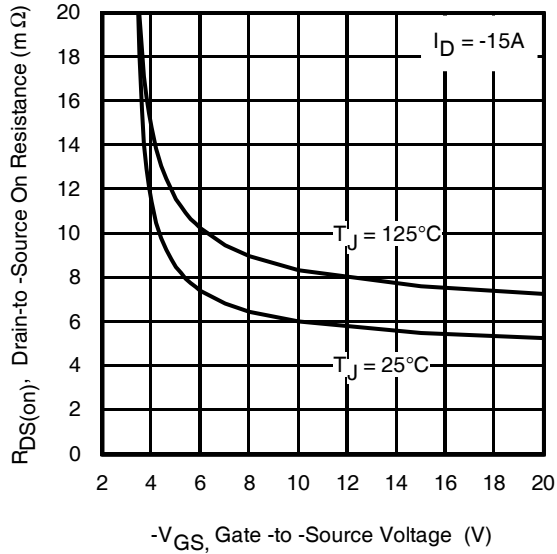

**Fig 12.** On-Resistance vs. Gate Voltage

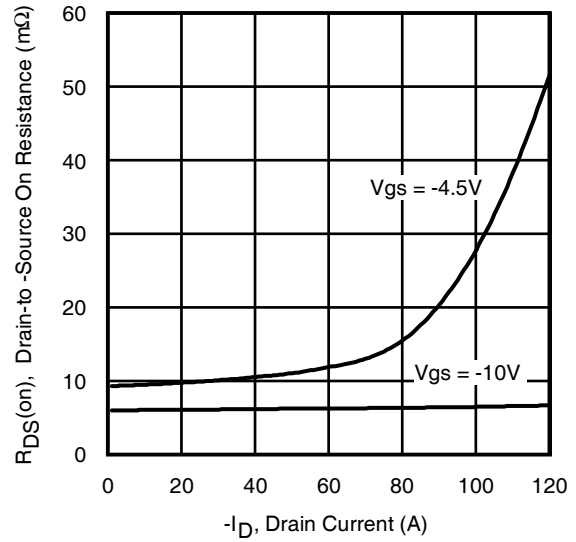

**Fig 13.** Typical On-Resistance vs. Drain Current

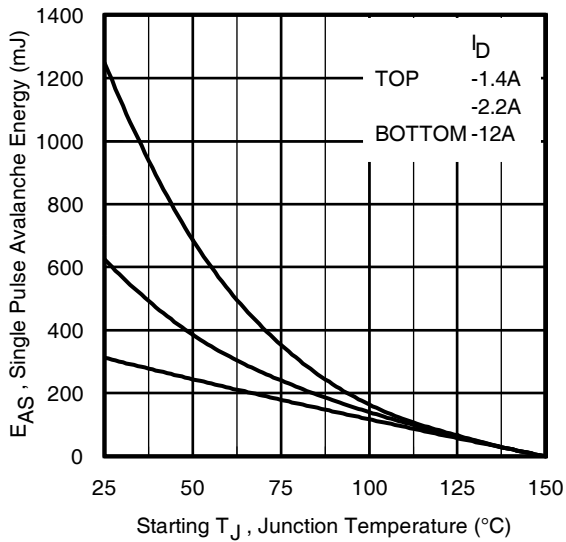

**Fig 14.** Maximum Avalanche Energy vs. Drain Current

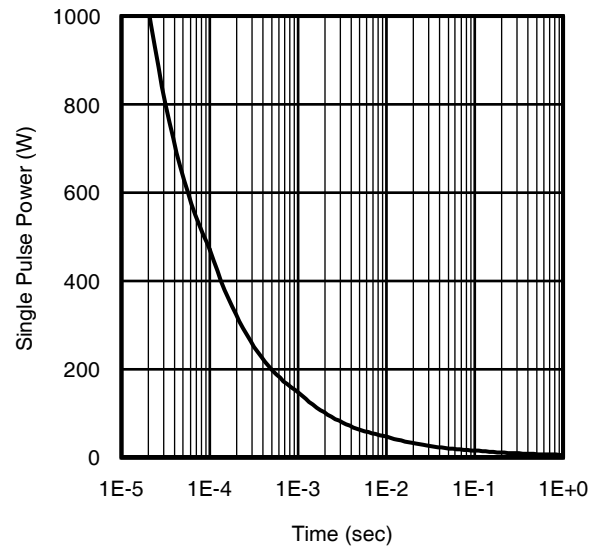

**Fig 15.** Typical Power vs. Time

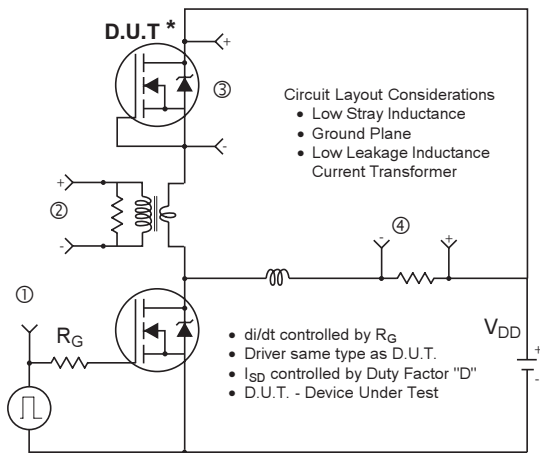

\* Reverse Polarity of D.U.T for P-Channel

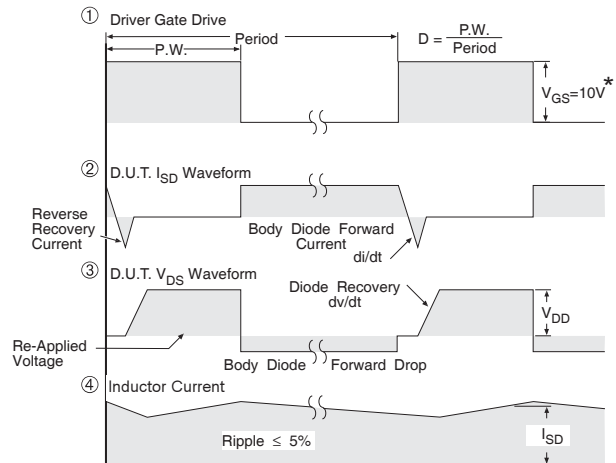

\*  $V_{GS} = 5V$  for Logic Level Devices

**Fig 16.** Diode Reverse Recovery Test Circuit for P-Channel HEXFET<sup>®</sup> Power MOSFETs

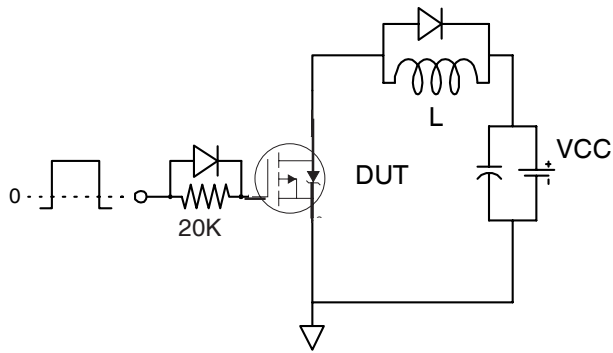

**Fig 17a.** Gate Charge Test Circuit



**Fig 17b.** Gate Charge Waveform

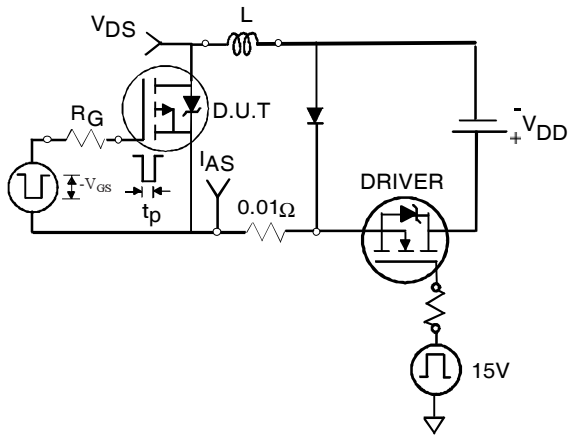

**Fig 18a.** Unclamped Inductive Test Circuit



**Fig 18b.** Unclamped Inductive Waveforms

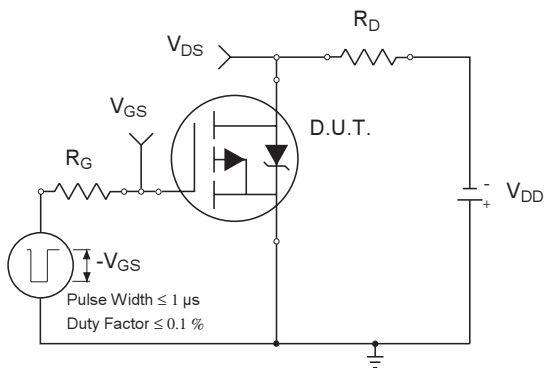

**Fig 19a.** Switching Time Test Circuit

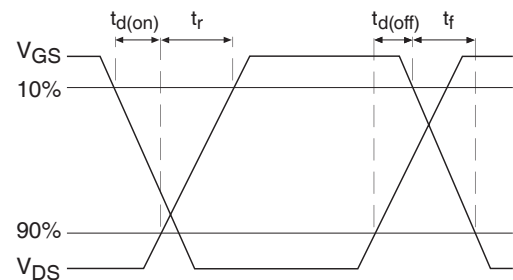

**Fig 19b.** Switching Time Waveforms

## SO-8 Package Outline (MOSFET & Fetky)

Dimensions are shown in millimeters (inches)



DIM	INCHES		MILLIMETERS	
	MIN	MAX	MIN	MAX
A	.0532	.0688	1.35	1.75
A1	.0040	.0098	0.10	0.25
b	.013	.020	0.33	0.51
c	.0075	.0098	0.19	0.25
D	.189	.1968	4.80	5.00
E	.1497	.1574	3.80	4.00
e	.050 BASIC		1.27 BASIC	
e 1	.025 BASIC		0.635 BASIC	
H	.2284	.2440	5.80	6.20
K	.0099	.0196	0.25	0.50
L	.016	.050	0.40	1.27
y	0°	8°	0°	8°

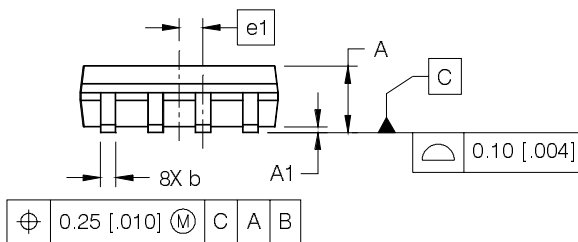

### FOOTPRINT



### NOTES:

1. DIMENSIONING & TOLERANCING PER ASME Y14.5M-1994.
2. CONTROLLING DIMENSION: MILLIMETER
3. DIMENSIONS ARE SHOWN IN MILLIMETERS [INCHES].
4. OUTLINE CONFORMS TO JEDEC OUTLINE MS-012AA.
- ⑤ DIMENSION DOES NOT INCLUDE MOLD PROTRUSIONS. MOLD PROTRUSIONS NOT TO EXCEED 0.15 [.006].
- ⑥ DIMENSION DOES NOT INCLUDE MOLD PROTRUSIONS. MOLD PROTRUSIONS NOT TO EXCEED 0.25 [.010].
- ⑦ DIMENSION IS THE LENGTH OF LEAD FOR SOLDERING TO A SUBSTRATE.

## SO-8 Part Marking Information

EXAMPLE: THIS IS AN IRF7101 (MOSFET)

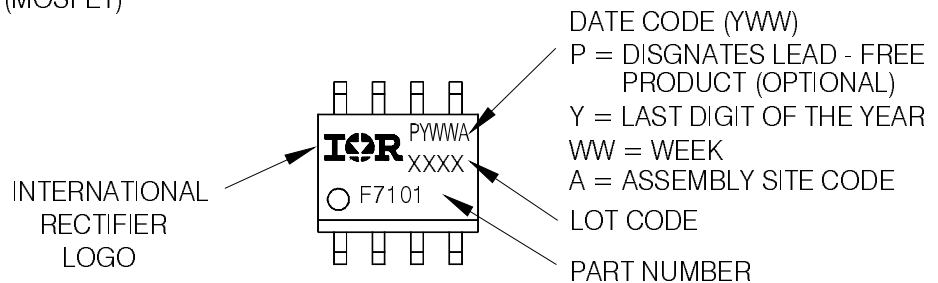

Note: For the most current drawing please refer to IR website at <http://www.irf.com/package/>

# IRF9321PbF

SO-8 Tape and Reel (Dimensions are shown in millimeters (inches))

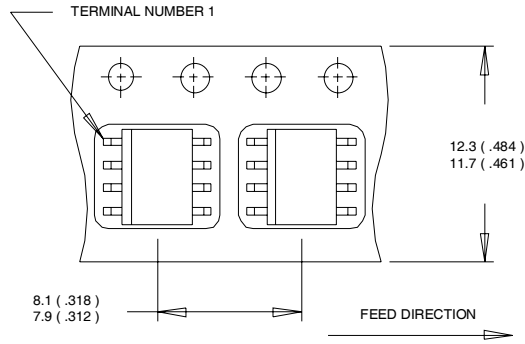

- NOTES:
1. CONTROLLING DIMENSION : MILLIMETER.
  2. ALL DIMENSIONS ARE SHOWN IN MILLIMETERS(INCHES).
  3. OUTLINE CONFORMS TO EIA-481 & EIA-541.

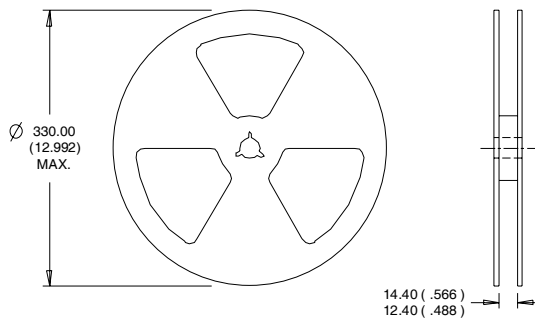

- NOTES :
1. CONTROLLING DIMENSION : MILLIMETER.
  2. OUTLINE CONFORMS TO EIA-481 & EIA-541.

## Qualification Information†

Qualification level	Consumer ††	
	(per JEDEC JESD47F††† guidelines)	
Moisture Sensitivity Level	SO-8	MSL1 (per JEDEC J-STD-020D†††)
RoHS Compliant	Yes	

† Qualification standards can be found at International Rectifier's web site  
<http://www.irf.com/product-info/reliability>

†† Higher qualification ratings may be available should the user have such requirements.  
Please contact your International Rectifier sales representative for further information:  
<http://www.irf.com/whoto-call/salesrep/>

††† Applicable version of JEDEC standard at the time of product release.

Data and specifications subject to change without notice.