

IRF8736PbF

HEXFET® Power MOSFET

Applications

- Synchronous MOSFET for Notebook Processor Power
- Synchronous Rectifier MOSFET for Isolated DC-DC Converters in Networking Systems

Benefits

- Very Low $R_{DS(on)}$ at 4.5V V_{GS}
- Low Gate Charge
- Fully Characterized Avalanche Voltage and Current
- 100% Tested for R_G
- Lead -Free

| V_{DSS} | $R_{DS(on)}$ max | Qg Typ. |
|-----------|--------------------------------|---------|
| 30V | 4.8m Ω @ $V_{GS} = 10V$ | 17nC |

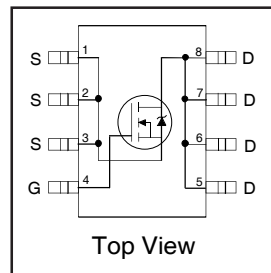

Absolute Maximum Ratings

| | Parameter | Max. | Units |
|--------------------------|---|--------------|---------------|
| V_{DS} | Drain-to-Source Voltage | 30 | V |
| V_{GS} | Gate-to-Source Voltage | ± 20 | |
| $I_D @ T_A = 25^\circ C$ | Continuous Drain Current, $V_{GS} @ 10V$ | 18 | A |
| $I_D @ T_A = 70^\circ C$ | Continuous Drain Current, $V_{GS} @ 10V$ | 14.4 | |
| I_{DM} | Pulsed Drain Current ① | 144 | |
| $P_D @ T_A = 25^\circ C$ | Power Dissipation ④ | 2.5 | W |
| $P_D @ T_A = 70^\circ C$ | Power Dissipation ④ | 1.6 | |
| | Linear Derating Factor | 0.02 | W/ $^\circ C$ |
| T_J T_{STG} | Operating Junction and Storage Temperature Range | -55 to + 150 | $^\circ C$ |

Thermal Resistance

| | Parameter | Typ. | Max. | Units |
|-----------------|--------------------------|------|------|--------------|
| $R_{\theta JL}$ | Junction-to-Drain Lead ⑤ | — | 20 | $^\circ C/W$ |
| $R_{\theta JA}$ | Junction-to-Ambient ④⑤ | — | 50 | |

Notes ① through ⑤ are on page 9

www.irf.com

Static @ T_J = 25°C (unless otherwise specified)

| | Parameter | Min. | Typ. | Max. | Units | Conditions |
|-------------------------------------|---|------|-------|------|-------|---|
| BV _{DSS} | Drain-to-Source Breakdown Voltage | 30 | — | — | V | V _{GS} = 0V, I _D = 250μA |
| ΔBV _{DSS} /ΔT _J | Breakdown Voltage Temp. Coefficient | — | 0.022 | — | V/°C | Reference to 25°C, I _D = 1mA |
| R _{DS(on)} | Static Drain-to-Source On-Resistance | — | 3.9 | 4.8 | mΩ | V _{GS} = 10V, I _D = 18A ③ |
| | | — | 5.5 | 6.8 | | V _{GS} = 4.5V, I _D = 14.4A ③ |
| V _{GS(th)} | Gate Threshold Voltage | 1.35 | 1.8 | 2.35 | V | V _{DS} = V _{GS} , I _D = 50μA |
| ΔV _{GS(th)} | Gate Threshold Voltage Coefficient | — | -6.1 | — | mV/°C | |
| I _{DSS} | Drain-to-Source Leakage Current | — | — | 1.0 | μA | V _{DS} = 24V, V _{GS} = 0V |
| | | — | — | 150 | | V _{DS} = 24V, V _{GS} = 0V, T _J = 125°C |
| I _{GSS} | Gate-to-Source Forward Leakage | — | — | 100 | nA | V _{GS} = 20V |
| | Gate-to-Source Reverse Leakage | — | — | -100 | | V _{GS} = -20V |
| g _{fs} | Forward Transconductance | 52 | — | — | S | V _{DS} = 15V, I _D = 14.4A |
| Q _g | Total Gate Charge | — | 17 | 26 | nC | V _{DS} = 15V V _{GS} = 4.5V I _D = 14.4A See Fig. 16 |
| Q _{gs1} | Pre-V _{th} Gate-to-Source Charge | — | 4.4 | — | | |
| Q _{gs2} | Post-V _{th} Gate-to-Source Charge | — | 1.9 | — | | |
| Q _{gd} | Gate-to-Drain Charge | — | 5.8 | — | | |
| Q _{godr} | Gate Charge Overdrive | — | 4.9 | — | | |
| Q _{sw} | Switch Charge (Q _{gs2} + Q _{gd}) | — | 7.7 | — | | |
| Q _{oss} | Output Charge | — | 7.1 | — | nC | V _{DS} = 10V, V _{GS} = 0V |
| R _G | Gate Resistance | — | 1.3 | 2.2 | Ω | |
| t _{d(on)} | Turn-On Delay Time | — | 12 | — | ns | V _{DD} = 15V, V _{GS} = 4.5V ③ I _D = 14.4A R _G = 1.8Ω See Fig. 14 |
| t _r | Rise Time | — | 15 | — | | |
| t _{d(off)} | Turn-Off Delay Time | — | 13 | — | | |
| t _f | Fall Time | — | 7.5 | — | | |
| C _{iss} | Input Capacitance | — | 2315 | — | pF | V _{GS} = 0V V _{DS} = 15V f = 1.0MHz |
| C _{oss} | Output Capacitance | — | 449 | — | | |
| C _{rss} | Reverse Transfer Capacitance | — | 219 | — | | |

Avalanche Characteristics

| | Parameter | Typ. | Max. | Units |
|-----------------|---------------------------------|------|------|-------|
| E _{AS} | Single Pulse Avalanche Energy ② | — | 126 | mJ |
| I _{AR} | Avalanche Current ① | — | 14.4 | A |

Diode Characteristics

| | Parameter | Min. | Typ. | Max. | Units | Conditions |
|-----------------|---|--|------|------|-------|---|
| I _S | Continuous Source Current (Body Diode) | — | — | 3.1 | A | MOSFET symbol showing the integral reverse p-n junction diode. |
| I _{SM} | Pulsed Source Current (Body Diode) ① | — | — | 144 | | |
| V _{SD} | Diode Forward Voltage | — | — | 1.0 | V | T _J = 25°C, I _S = 14.4A, V _{GS} = 0V ③ |
| t _{rr} | Reverse Recovery Time | — | 16 | 24 | ns | T _J = 25°C, I _F = 14.4A, V _{DD} = 10V |
| Q _{rr} | Reverse Recovery Charge | — | 19 | 29 | nC | di/dt = 300A/μs ③ |
| t _{on} | Forward Turn-On Time | Intrinsic turn-on time is negligible (turn-on is dominated by LS+LD) | | | | |

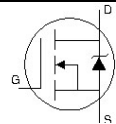

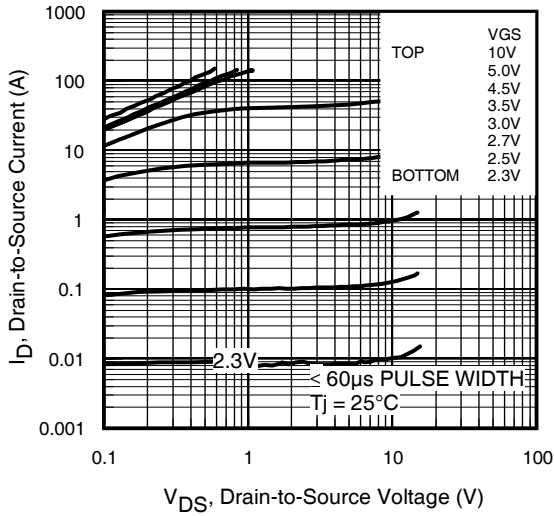

Fig 1. Typical Output Characteristics

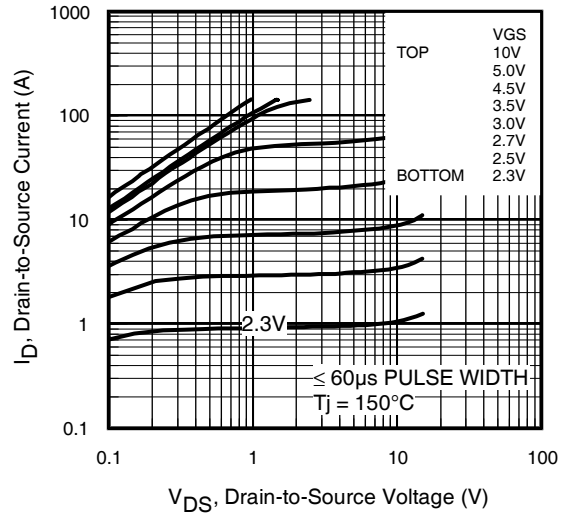

Fig 2. Typical Output Characteristics

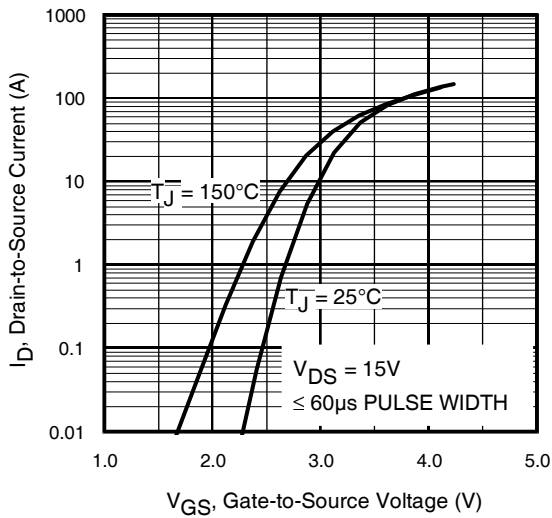

Fig 3. Typical Transfer Characteristics

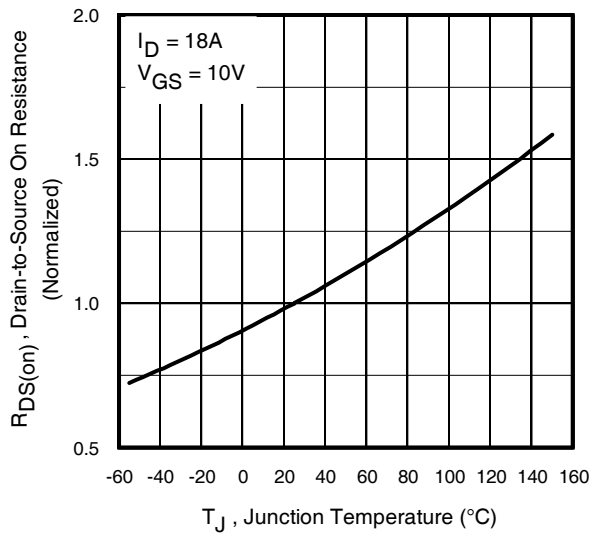

Fig 4. Normalized On-Resistance Vs. Temperature

IRF8736PbF

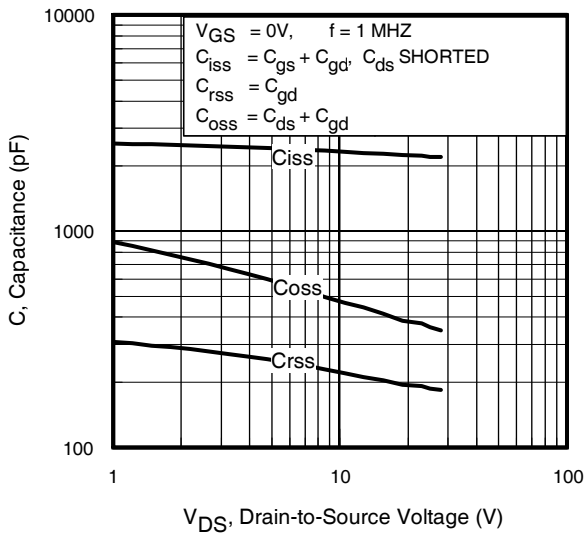

Fig 5. Typical Capacitance Vs. Drain-to-Source Voltage

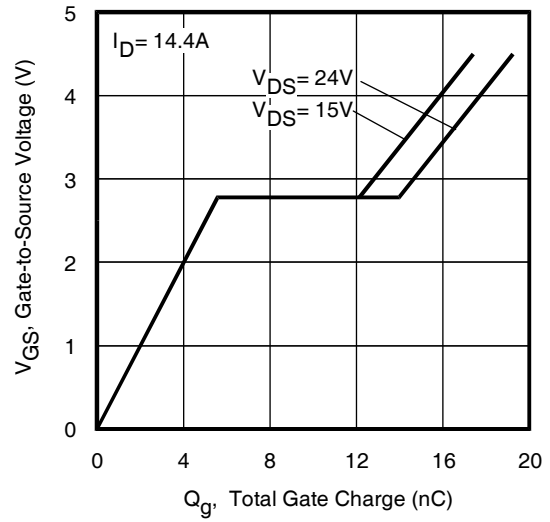

Fig 6. Typical Gate Charge Vs. Gate-to-Source Voltage

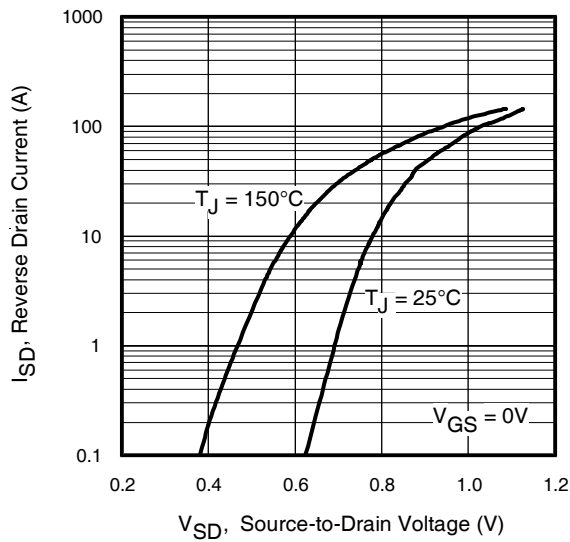

Fig 7. Typical Source-Drain Diode Forward Voltage

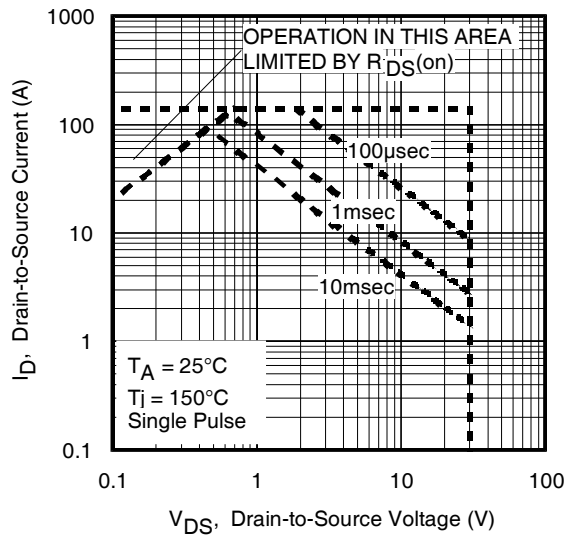

Fig 8. Maximum Safe Operating Area

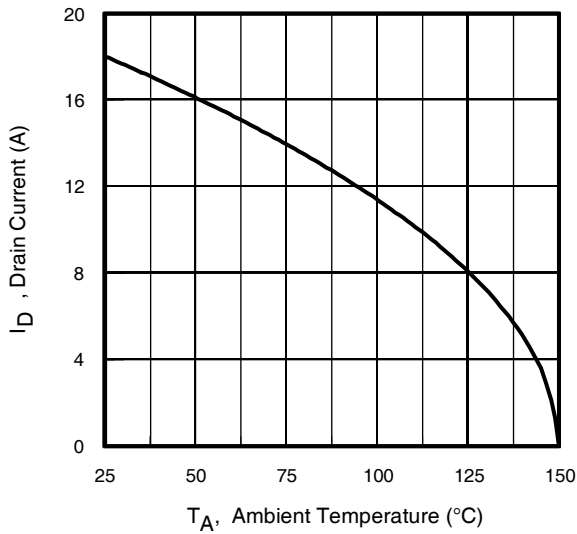

Fig 9. Maximum Drain Current Vs. Ambient Temperature

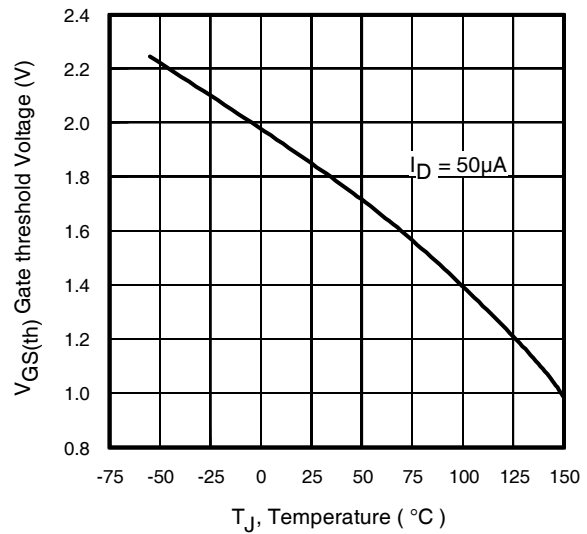

Fig 10. Threshold Voltage Vs. Temperature

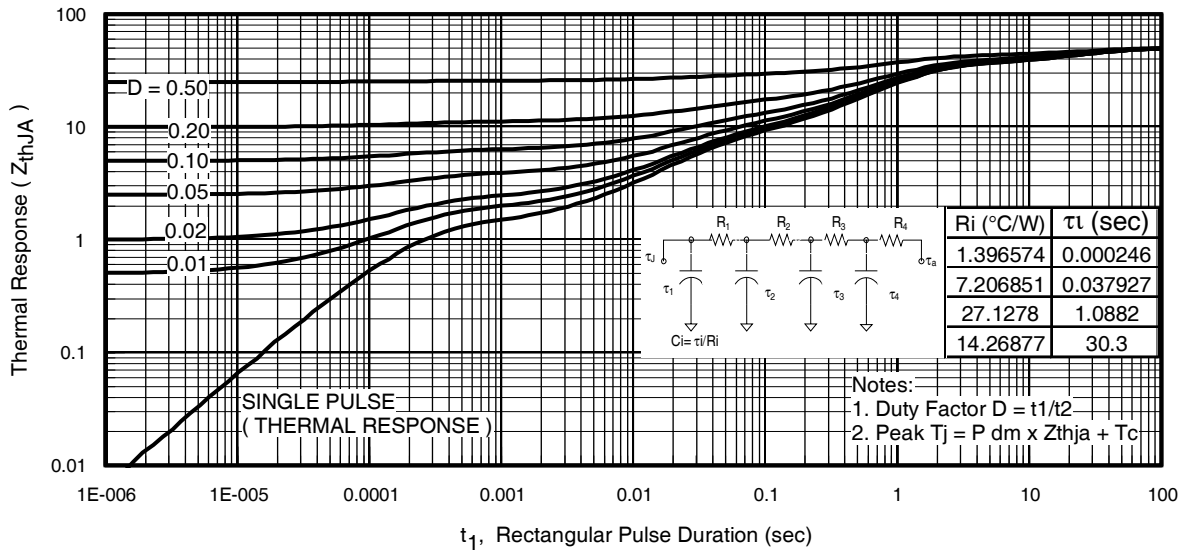

Fig 11. Maximum Effective Transient Thermal Impedance, Junction-to-Ambient

IRF8736PbF

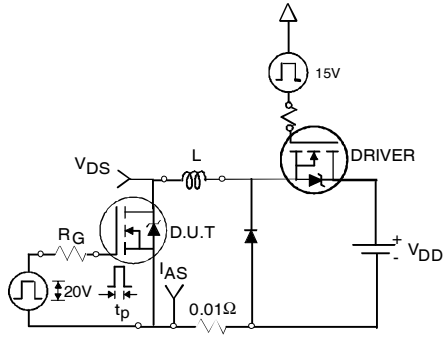

Fig 12a. Unclamped Inductive Test Circuit

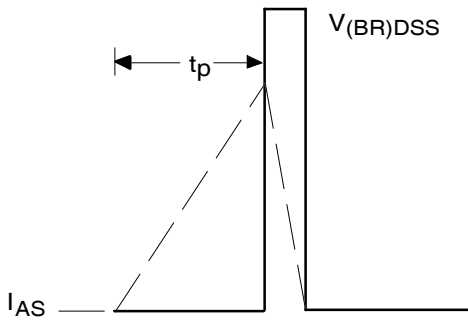

Fig 12b. Unclamped Inductive Waveforms

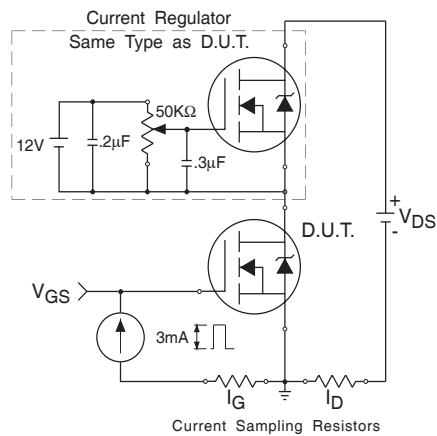

Fig 13. Gate Charge Test Circuit

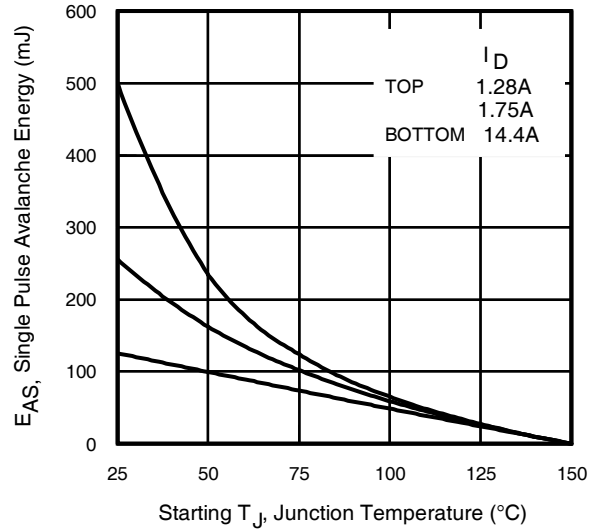

Fig 12c. Maximum Avalanche Energy Vs. Drain Current

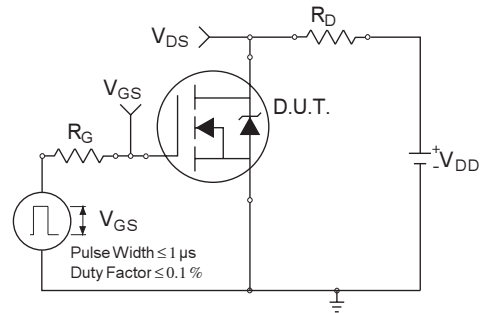

Fig 14a. Switching Time Test Circuit

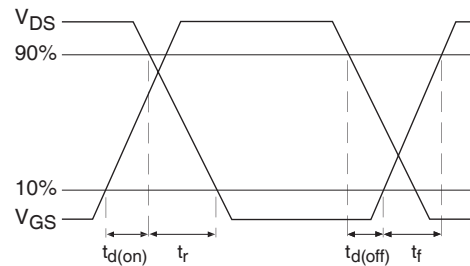

Fig 14b. Switching Time Waveforms

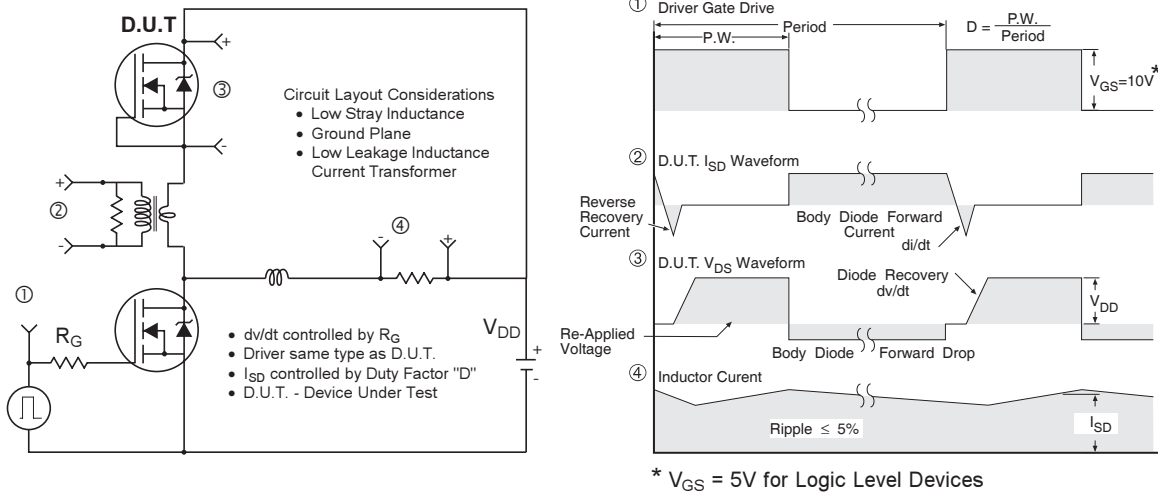

Fig 15. Peak Diode Recovery dv/dt Test Circuit for N-Channel HEXFET® Power MOSFETs

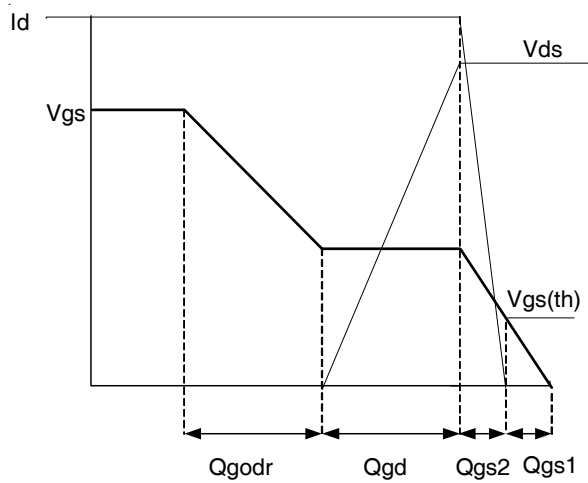

Fig 16. Gate Charge Waveform

IRF8736PbF

International
IR Rectifier

SO-8 Package Outline

Dimensions are shown in millimeters (inches)

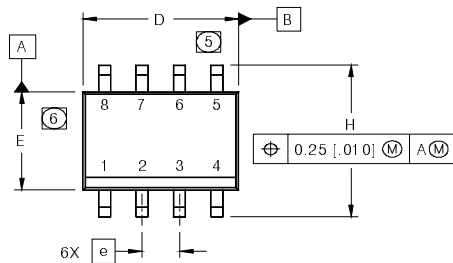

| DIM | INCHES | | MILLIMETERS | |
|-----|--------|-------|-------------|-------|
| | MIN | MAX | MIN | MAX |
| A | .0532 | .0688 | 1.35 | 1.75 |
| A1 | .0040 | .0098 | 0.10 | 0.25 |
| b | .013 | .020 | 0.33 | 0.51 |
| c | .0075 | .0098 | 0.19 | 0.25 |
| D | .189 | .1968 | 4.80 | 5.00 |
| E | .1497 | .1574 | 3.80 | 4.00 |
| e | .050 | BASIC | 1.27 | BASIC |
| e1 | .025 | BASIC | 0.635 | BASIC |
| H | .2284 | .2440 | 5.80 | 6.20 |
| K | .0099 | .0196 | 0.25 | 0.50 |
| L | .016 | .050 | 0.40 | 1.27 |
| y | 0° | 8° | 0° | 8° |

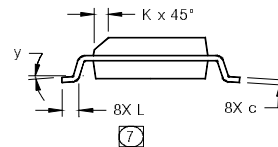
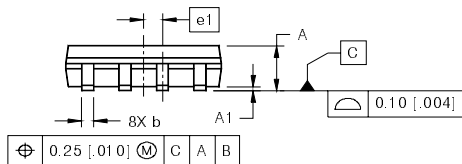

FOOTPRINT

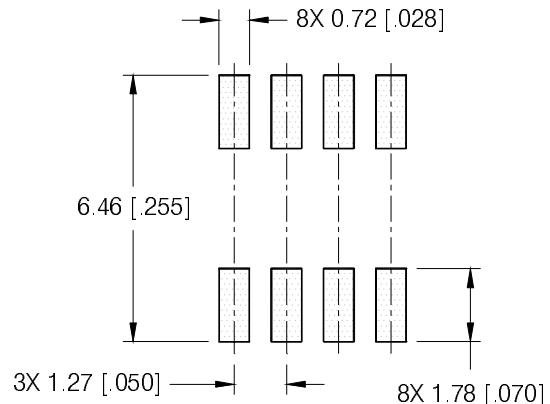

NOTES:

1. DIMENSIONING & TOLERANCING PER ASME Y14.5M-1994.
2. CONTROLLING DIMENSION: MILLIMETER
3. DIMENSIONS ARE SHOWN IN MILLIMETERS [INCHES].
4. OUTLINE CONFORMS TO JEDEC OUTLINE MS-012AA.
5. DIMENSION DOES NOT INCLUDE MOLD PROTRUSIONS. MOLD PROTRUSIONS NOT TO EXCEED 0.15 [0.006].
6. DIMENSION DOES NOT INCLUDE MOLD PROTRUSIONS. MOLD PROTRUSIONS NOT TO EXCEED 0.25 [0.010].
7. DIMENSION IS THE LENGTH OF LEAD FOR SOLDERING TO A SUBSTRATE.

SO-8 Part Marking Information

EXAMPLE: THIS IS AN IRF7101 (MOSFET)

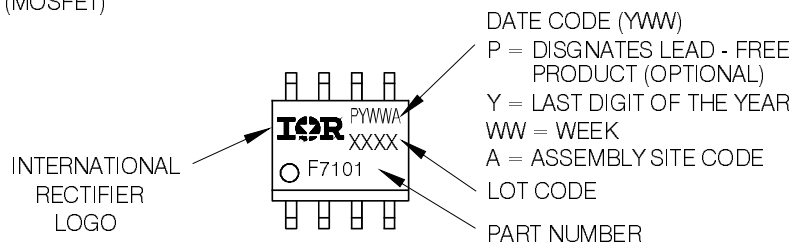

Note: For the most current drawing please refer to IR website at <http://www.irf.com/package>

SO-8 Tape and Reel

Dimensions are shown in millimeters (inches)

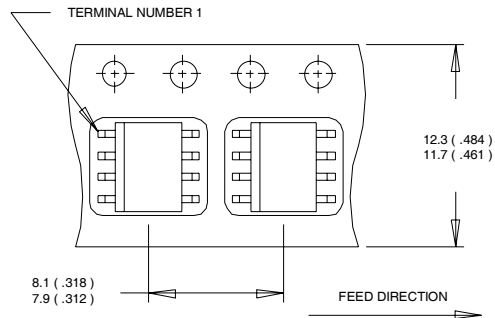

- NOTES:
1. CONTROLLING DIMENSION : MILLIMETER.
 2. ALL DIMENSIONS ARE SHOWN IN MILLIMETERS(INCHES).
 3. OUTLINE CONFORMS TO EIA-481 & EIA-541.

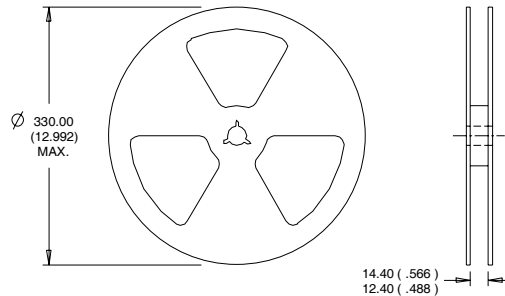

- NOTES :
1. CONTROLLING DIMENSION : MILLIMETER.
 2. OUTLINE CONFORMS TO EIA-481 & EIA-541.

Note: For the most current drawing please refer to IR website at <http://www.irf.com/package>

Notes:

- ① Repetitive rating; pulse width limited by max. junction temperature.
- ② Starting $T_J = 25^\circ\text{C}$, $L = 1.21\text{mH}$, $R_G = 25\Omega$, $I_{AS} = 14.4\text{A}$.
- ③ Pulse width $\leq 400\mu\text{s}$; duty cycle $\leq 2\%$.
- ④ When mounted on 1 inch square copper board
- ⑤ R_{θ} is measured at T_J approximately 90°C

Data and specifications subject to change without notice.
 This product has been designed and qualified for the Consumer market.
 Qualification Standards can be found on IR's Web site.