

# IRF6201PbF

HEXFET® Power MOSFET

<b>V<sub>DS</sub></b>	<b>20</b>	<b>V</b>
<b>R<sub>DS(on)</sub> max</b> (@V <sub>GS</sub> = 4.5V)	<b>2.45</b>	<b>mΩ</b>
<b>R<sub>DS(on)</sub> max</b> (@V <sub>GS</sub> = 2.5V)	<b>2.75</b>	<b>mΩ</b>
<b>Q<sub>g</sub> (typical)</b>	<b>130</b>	<b>nC</b>
<b>I<sub>D</sub></b> (@T <sub>A</sub> = 25°C)	<b>27</b>	<b>A</b>

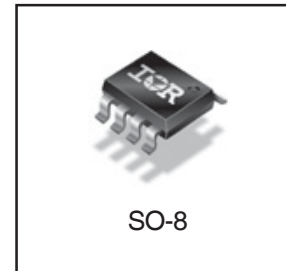
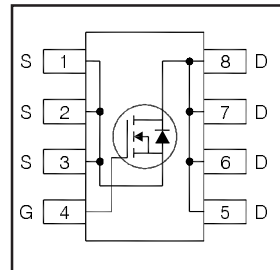

## Applications

- OR-ing or hot-swap MOSFET
- Battery operated DC motor inverter MOSFET
- System/Load switch

## Features and Benefits

### Features

Low R <sub>DSon</sub> (≤ 2.45mΩ @ V <sub>gs</sub> = 4.5V)
Industry-standard SO-8 package
RoHS compliant containing no lead, no bromide and no halogen

results in  
 ⇒

### Benefits

Lower conduction losses
Multi-vendor compatibility
Environmentally Friendly

Orderable part number	Package Type	Standard Pack		Note
		Form	Quantity	
IRF6201PbF	SO8	Tube/Bulk	95	
IRF6201TRPbF	SO8	Tape and Reel	4000	

## Absolute Maximum Ratings

	Parameter	Max.	Units
V <sub>DS</sub>	Drain-to-Source Voltage	20	V
V <sub>GS</sub>	Gate-to-Source Voltage	±12	
I <sub>D</sub> @ T <sub>A</sub> = 25°C	Continuous Drain Current, V <sub>GS</sub> @ 4.5V	27	A
I <sub>D</sub> @ T <sub>A</sub> = 70°C	Continuous Drain Current, V <sub>GS</sub> @ 4.5V	22	
I <sub>DM</sub>	Pulsed Drain Current ①	110	
P <sub>D</sub> @ T <sub>A</sub> = 25°C	Power Dissipation ③	2.5	W
P <sub>D</sub> @ T <sub>A</sub> = 70°C	Power Dissipation ③	1.6	
	Linear Derating Factor	0.02	W/°C
T <sub>J</sub>	Operating Junction and	-55 to + 150	°C
T <sub>STG</sub>	Storage Temperature Range		

## Static @ $T_J = 25^\circ\text{C}$ (unless otherwise specified)

	Parameter	Min.	Typ.	Max.	Units	Conditions
$BV_{DSS}$	Drain-to-Source Breakdown Voltage	20	—	—	V	$V_{GS} = 0V, I_D = 250\mu A$
$\Delta BV_{DSS}/\Delta T_J$	Breakdown Voltage Temp. Coefficient	—	4.6	—	mV/ $^\circ\text{C}$	Reference to $25^\circ\text{C}, I_D = 1\text{mA}$
$R_{DS(on)}$	Static Drain-to-Source On-Resistance	—	1.90	2.45	m $\Omega$	$V_{GS} = 4.5V, I_D = 27A$ ②
		—	2.10	2.75		$V_{GS} = 2.5V, I_D = 22A$ ②
$V_{GS(th)}$	Gate Threshold Voltage	0.5	—	1.1	V	$V_{DS} = V_{GS}, I_D = 100\mu A$
$I_{DSS}$	Drain-to-Source Leakage Current	—	—	1.0	$\mu A$	$V_{DS} = 16V, V_{GS} = 0V$
		—	—	150		$V_{DS} = 16V, V_{GS} = 0V, T_J = 125^\circ\text{C}$
$I_{GSS}$	Gate-to-Source Forward Leakage	—	—	100	nA	$V_{GS} = 12V$
	Gate-to-Source Reverse Leakage	—	—	-100		$V_{GS} = -12V$
$Q_g$	Total Gate Charge	—	130	195	nC	$V_{GS} = 4.5V$
$Q_{gs}$	Gate-to-Source Charge	—	16	—		$V_{DS} = 10V$
$Q_{gd}$	Gate-to-Drain Charge	—	60	—		$I_D = 22A$
$t_{d(on)}$	Turn-On Delay Time	—	29	—	ns	$V_{DD} = 20V, V_{GS} = 4.5V$
$t_r$	Rise Time	—	100	—		$I_D = 1.0A$
$t_{d(off)}$	Turn-Off Delay Time	—	320	—		$R_G = 6.8\Omega$
$t_f$	Fall Time	—	265	—		See Figs. 10a & 10b
$C_{iss}$	Input Capacitance	—	8555	—	pF	$V_{GS} = 0V$
$C_{oss}$	Output Capacitance	—	1735	—		$V_{DS} = 16V$
$C_{riss}$	Reverse Transfer Capacitance	—	1290	—		$f = 1.0\text{MHz}$

## Diode Characteristics

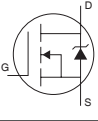
	Parameter	Min.	Typ.	Max.	Units	Conditions
$I_S$	Continuous Source Current (Body Diode)	—	—	2.5	A	MOSFET symbol showing the integral reverse p-n junction diode. 
$I_{SM}$	Pulsed Source Current (Body Diode) ①	—	—	110		
$V_{SD}$	Diode Forward Voltage	—	—	1.2	V	$T_J = 25^\circ\text{C}, I_S = 2.5A, V_{GS} = 0V$ ②
$t_{rr}$	Reverse Recovery Time	—	82	120	ns	$T_J = 25^\circ\text{C}, I_F = 2.5A, V_{DD} = 16V$
$Q_{rr}$	Reverse Recovery Charge	—	180	270	nC	$di/dt = 100/\mu s$ ②

## Thermal Resistance

	Parameter	Typ.	Max.	Units
$R_{\theta JL}$	Junction-to-Drain Lead ④	—	20	$^\circ\text{C/W}$
$R_{\theta JA}$	Junction-to-Ambient ③	—	50	

### Notes:

- ① Repetitive rating; pulse width limited by max. junction temperature.
- ② Pulse width  $\leq 400\mu s$ ; duty cycle  $\leq 2\%$ .
- ③ When mounted on 1 inch square copper board.
- ④  $R_{\theta}$  is measured at  $T_J$  approximately  $90^\circ\text{C}$ .

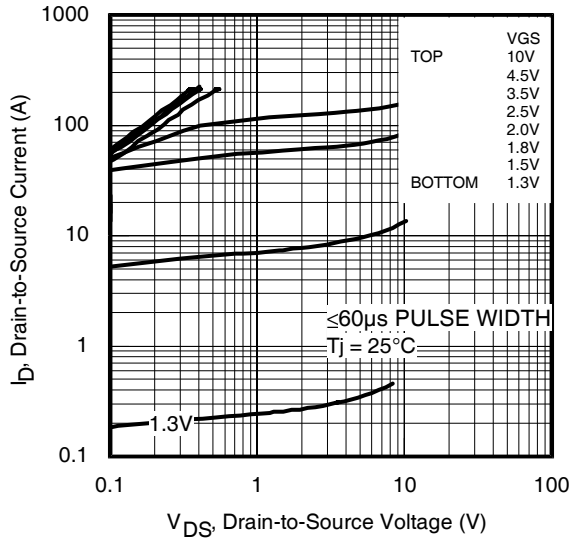

**Fig 1.** Typical Output Characteristics

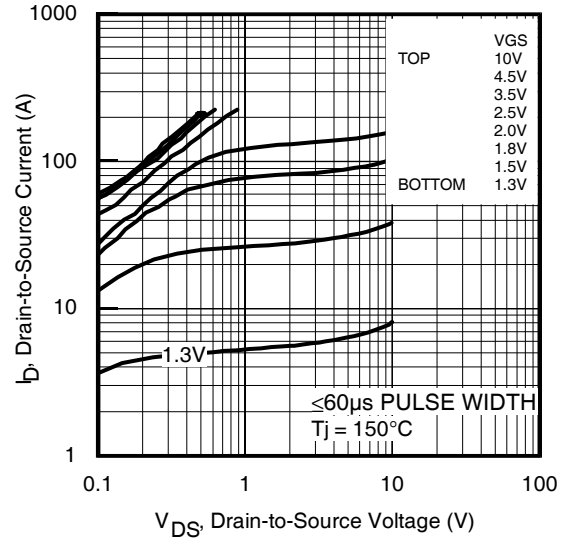

**Fig 2.** Typical Output Characteristics

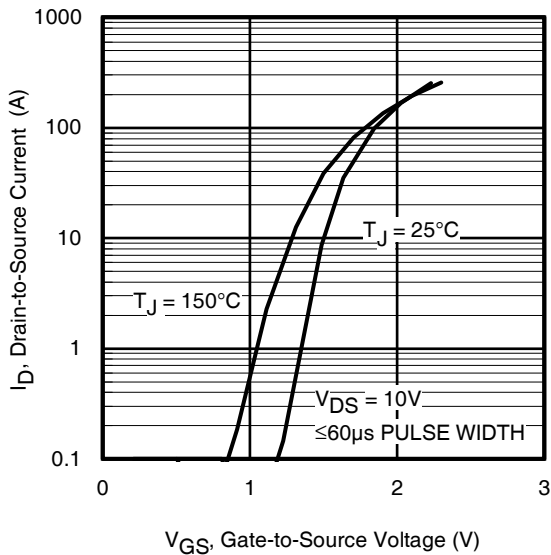

**Fig 3.** Typical Transfer Characteristics

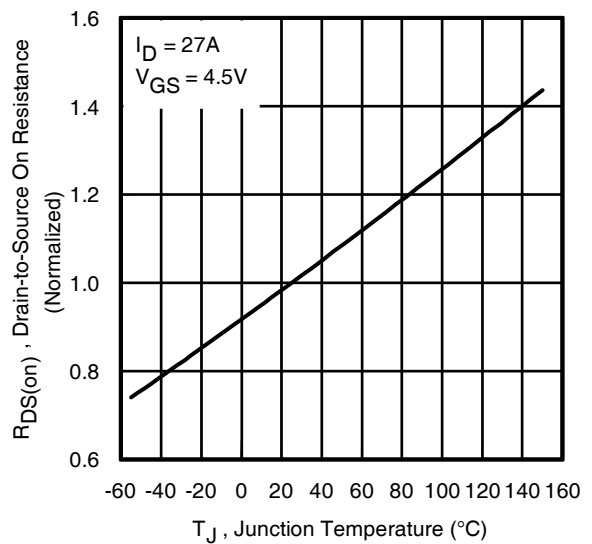

**Fig 4.** Normalized On-Resistance vs. Temperature

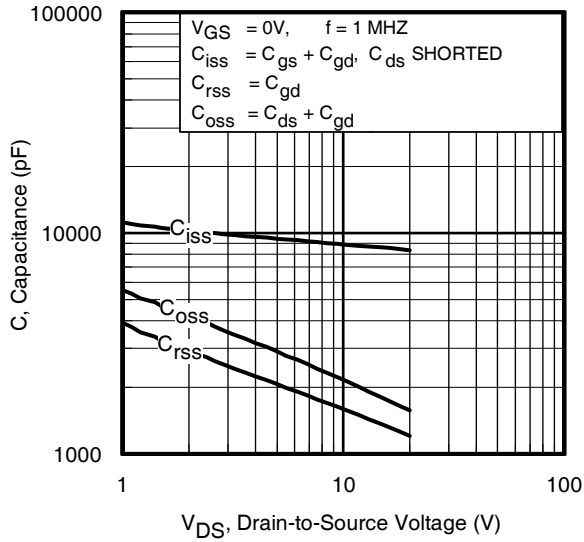

**Fig 5.** Typical Capacitance vs. Drain-to-Source Voltage

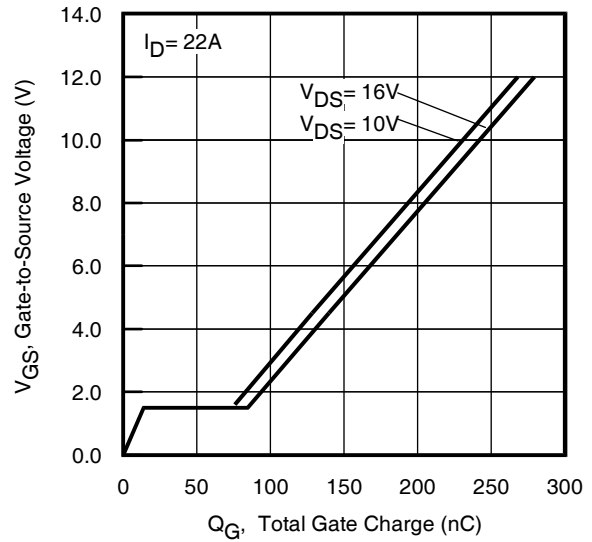

**Fig 6.** Typical Gate Charge vs. Gate-to-Source Voltage

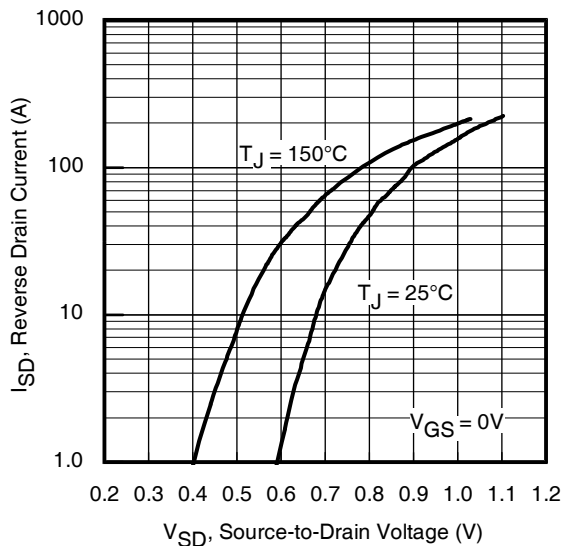

**Fig 7.** Typical Source-Drain Diode Forward Voltage

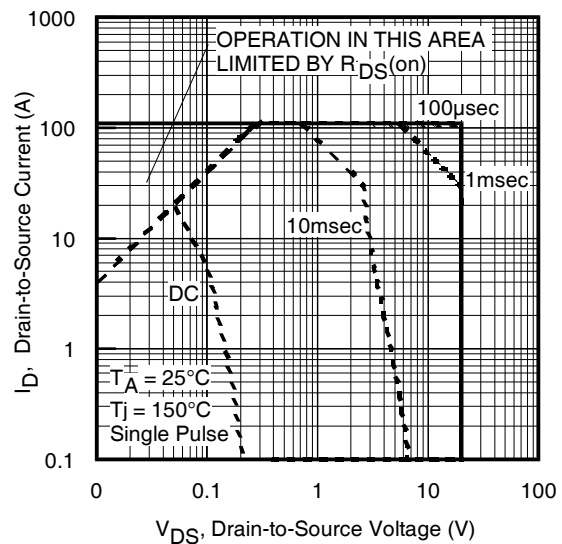

**Fig 8.** Maximum Safe Operating Area

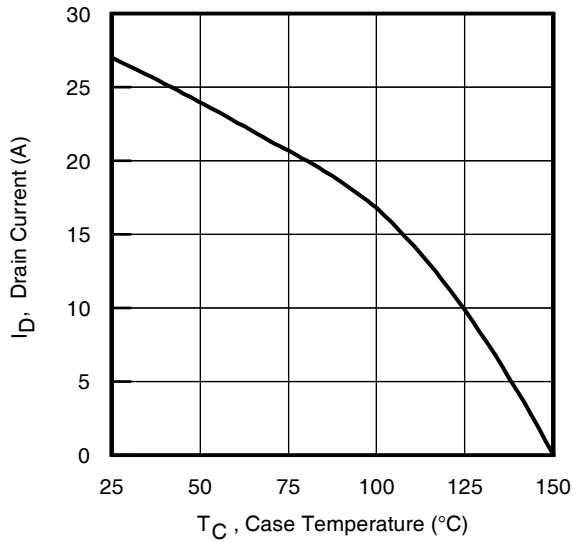

**Fig 9.** Maximum Drain Current vs. Case Temperature

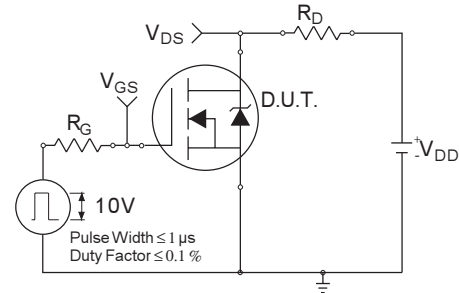

**Fig 10a.** Switching Time Test Circuit

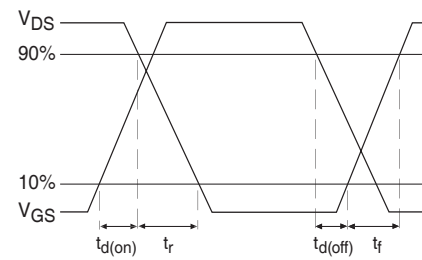

**Fig 10b.** Switching Time Waveforms

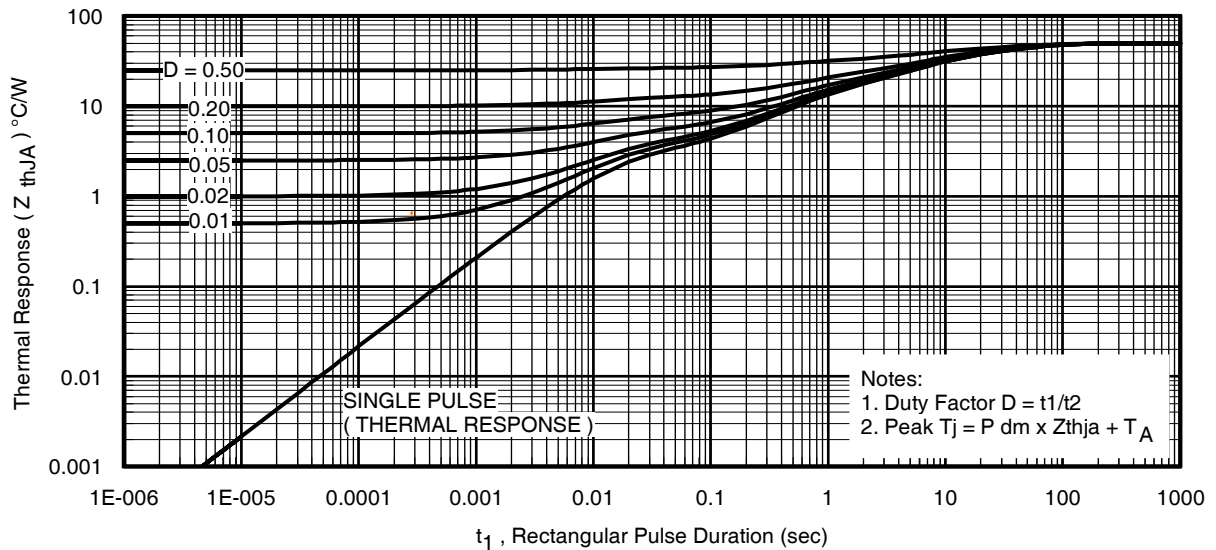

**Fig 11.** Typical Effective Transient Thermal Impedance, Junction-to-Ambient

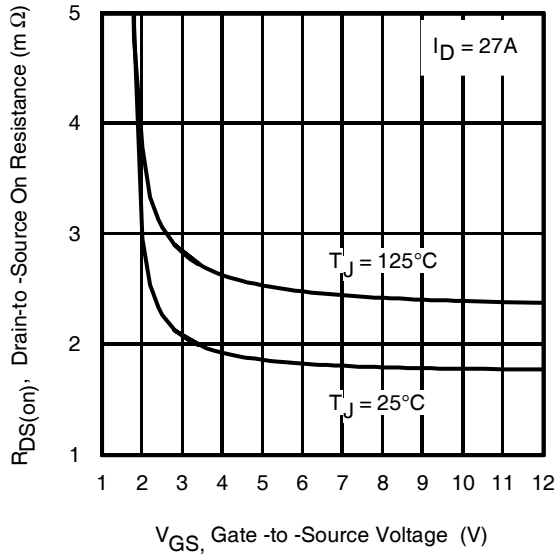

**Fig 12.** Typical On-Resistance vs. Gate Voltage

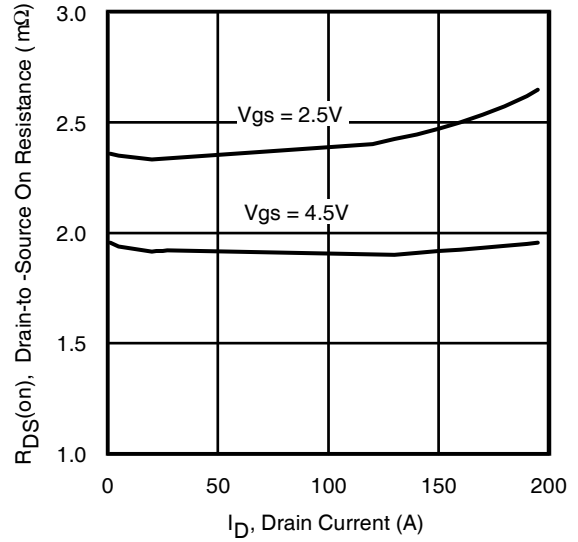

**Fig 13.** Typical On-Resistance vs. Drain Current

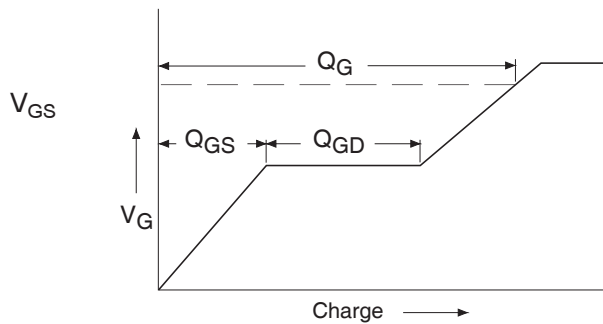

**Fig 14a.** Basic Gate Charge Waveform

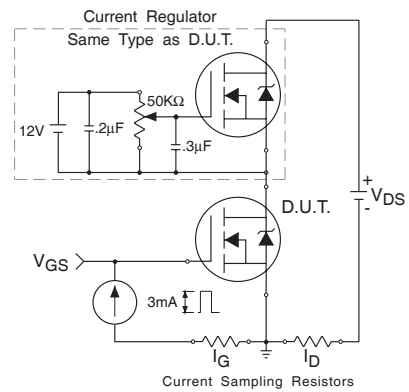

**Fig 14b.** Gate Charge Test Circuit

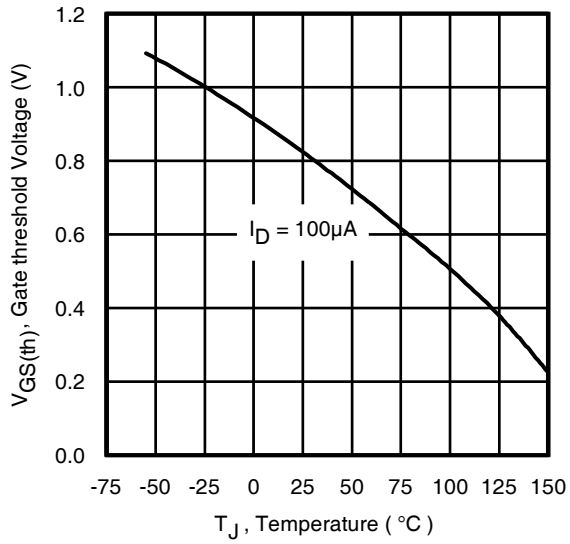

**Fig 15.** Typical Threshold Voltage vs. Junction Temperature

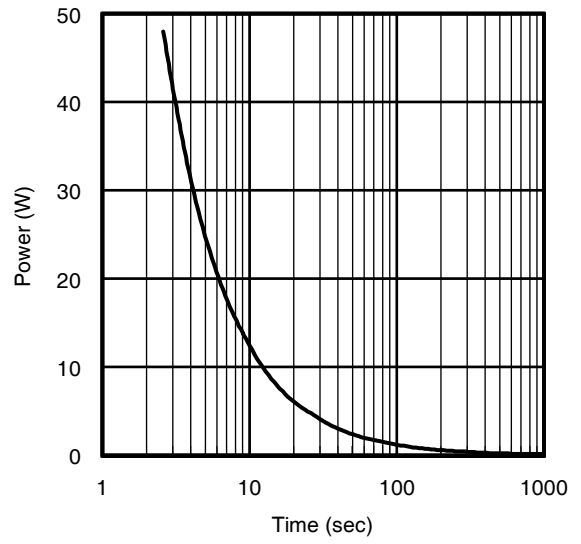
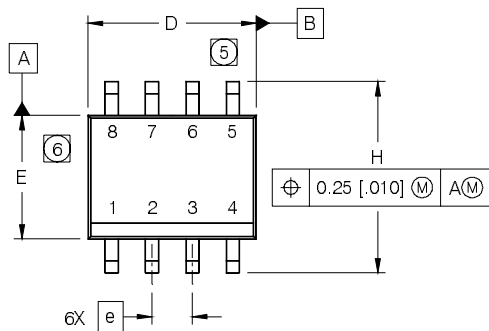

**Fig 16.** Typical Power vs. Time

# IRF6201PbF

## SO-8 Package Outline (Mosfet & Fetky)

Dimensions are shown in millimeters (inches)



DIM	INCHES		MILLIMETERS	
	MIN	MAX	MIN	MAX
A	.0532	.0688	1.35	1.75
A1	.0040	.0098	0.10	0.25
b	.013	.020	0.33	0.51
c	.0075	.0098	0.19	0.25
D	.189	.1968	4.80	5.00
E	.1497	.1574	3.80	4.00
e	.050 BASIC		1.27 BASIC	
e1	.025 BASIC		0.635 BASIC	
H	.2284	.2440	5.80	6.20
K	.0099	.0196	0.25	0.50
L	.016	.050	0.40	1.27
y	0°	8°	0°	8°

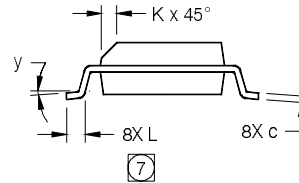
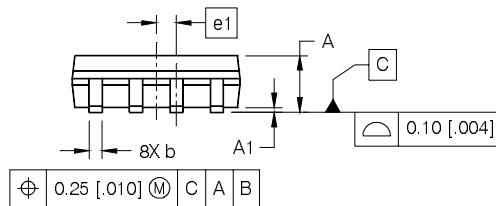

### NOTES:

1. DIMENSIONING & TOLERANCING PER ASME Y14.5M-1994.
2. CONTROLLING DIMENSION: MILLIMETER
3. DIMENSIONS ARE SHOWN IN MILLIMETERS [INCHES].
4. OUTLINE CONFORMS TO JEDEC OUTLINE MS-012AA.
- ⑤ DIMENSION DOES NOT INCLUDE MOLD PROTRUSIONS. MOLD PROTRUSIONS NOT TO EXCEED 0.15 [0.006].
- ⑥ DIMENSION DOES NOT INCLUDE MOLD PROTRUSIONS. MOLD PROTRUSIONS NOT TO EXCEED 0.25 [0.010].
- ⑦ DIMENSION IS THE LENGTH OF LEAD FOR SOLDERING TO A SUBSTRATE.

### FOOTPRINT

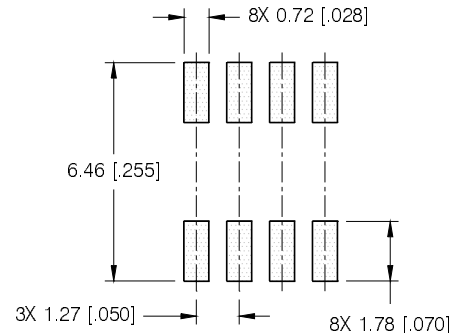

## SO-8 Part Marking Information

EXAMPLE: THIS IS AN IRF7101 (MOSFET)

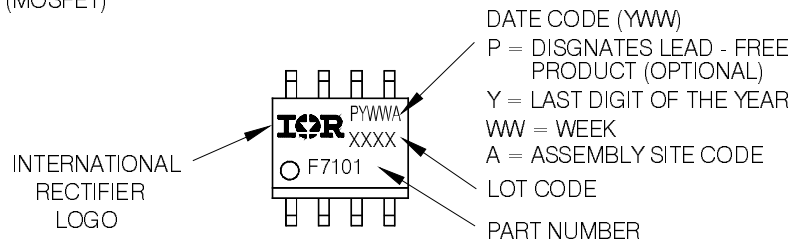

Note: For the most current drawing please refer to IR website at <http://www.irf.com/package/>



## SO-8 Tape and Reel

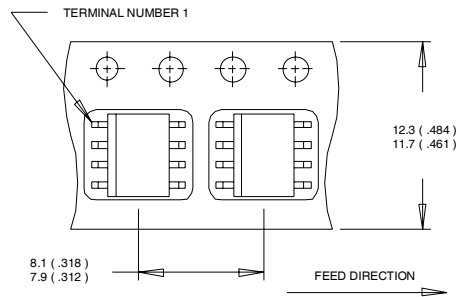

- NOTES:
1. CONTROLLING DIMENSION : MILLIMETER.
  2. ALL DIMENSIONS ARE SHOWN IN MILLIMETERS(INCHES).
  3. OUTLINE CONFORMS TO EIA-481 & EIA-541.

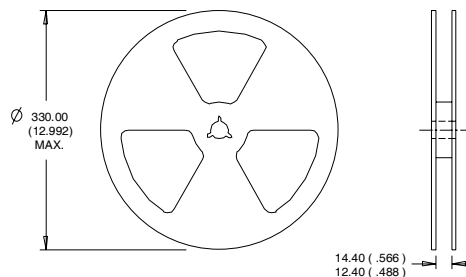

- NOTES :
1. CONTROLLING DIMENSION : MILLIMETER.
  2. OUTLINE CONFORMS TO EIA-481 & EIA-541.

### Qualification Information<sup>†</sup>

Qualification level	Consumer <sup>††</sup> (per JEDEC JESD47F <sup>†††</sup> guidelines)	
Moisture Sensitivity Level	SO-8	MSL1 (per JEDEC J-STD-020D <sup>†††</sup> )
RoHS Compliant	Yes	

<sup>†</sup> Qualification standards can be found at International Rectifier's web site

<http://www.irf.com/product-info/reliability>

<sup>††</sup> Higher qualification ratings may be available should the user have such requirements.

Please contact your International Rectifier sales representative for further information:

<http://www.irf.com/whoto-call/salesrep/>

<sup>†††</sup> Applicable version of JEDEC standard at the time of product release.

Data and specifications subject to change without notice.