

DESCRIPTION

The BUX48B/C, BUV48B/C and BUV48BFI/CFI are silicon multiepitaxial mesa NPN transistors mounted respectively in TO-3 metal case, TO-218 plastic package and ISOWATT218 fully isolated package. They are particularly intended for switching and industrial applications from single and three-phase mains.

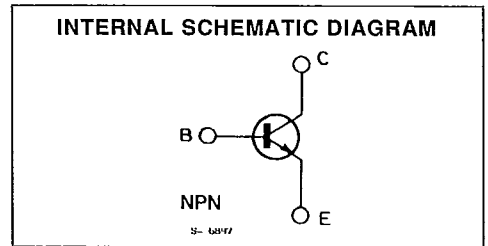
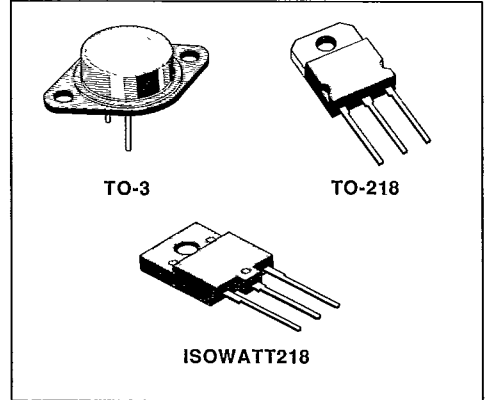

ABSOLUTE MAXIMUM RATINGS

Symbol	Parameter	Value			Unit
		BUX48B BUV48B BUV48BFI	TO-218	BUX48C BUV48C BUV48CFI	
V _{CER}	Collector-emitter Voltage (R _{BE} = 10Ω)	1200		1200	V
V _{CES}	Collector-emitter Voltage (V _{BE} = 0)	1200		1200	V
V _{CEO}	Collector-emitter Voltage (I _B = 0)	600		700	V
V _{EBO}	Emitter-base Voltage (I _C = 0)		7		V
I _C	Collector Current		15		A
I _{CM}	Collector Peak Current (t _p < 5ms)		30		A
I _{CP}	Collector Peak Current non Repetitive (t _p < 20μs)		55		A
I _B	Base Current		4		A
I _{BM}	Base Peak Current (t _p < 5ms)		20		A
		TO-3	TO-218	ISOWATT218	
P _{tot}	Total Dissipation at T _c < 25°C	175	125	65	W
T _{stg}	Storage Temperature	- 65 to 200	- 65 to 150	- 65 to 150	°C
T _j	Max. Operating Junction Temperature	200	150	150	°C

THERMAL DATA

$R_{th\ j-case}$	Thermal Resistance Junction-case	max	TO-3	TO-218	ISOWATT218	
			1	1	1.92	°C/W

ELECTRICAL CHARACTERISTICS ($T_{case} = 25\text{ °C}$ unless otherwise specified)

Symbol	Parameter	Test Conditions	Min.	Typ.	Max.	Unit
I_{CER}	Collector Cutoff Current ($R_{BE} = 10\ \Omega$)	$V_{CE} = 1200\text{ V}$ $V_{CE} = 1200\text{ V}$ $T_{case} = 125\text{ °C}$			500 4	μA mA
I_{CES}	Collector Cutoff Current ($V_{BE} = 0$)	$V_{CE} = 1200\text{ V}$ $V_{CE} = 1200\text{ V}$ $T_{case} = 125\text{ °C}$			500 3	μA mA
I_{CEO}	Collector Cutoff Current ($I_B = 0$)	$V_{CE} = V_{CEO}$			1	mA
I_{EBO}	Emitter Cutoff Current ($I_C = 0$)	$V_{EB} = 6\text{ V}$			1	mA
$V_{CEO(sus)}^*$	Collector-emitter Sustaining Voltage ($I_B = 0$)	$I_C = 100\text{ mA}$ for BUX48B/BUV48B/BUV48BFI for BUX48C/BUV48C/BUV48CFI	600 700			V
$V_{CER(sus)}^*$	Collector-emitter Sustaining Voltage ($R_{BE} = 10\ \Omega$)	$I_C = 0.5\text{ A}$ $L = 2\text{ mH}$ $V_{clamp} = 1200\text{ V}$	1200			V
$V_{CE(sat)}^*$	Collector-emitter Saturation Voltage	$I_C = 6\text{ A}$ $I_B = 1.5\text{ A}$ $I_C = 10\text{ A}$ $I_B = 4\text{ A}$			1.5 3	V V
$V_{BE(sat)}^*$	Base-emitter Saturation Voltage	$I_C = 6\text{ A}$ $I_B = 1.5\text{ A}$ $I_C = 10\text{ A}$ $I_B = 4\text{ A}$			1.5 2	V V

* Pulsed : pulse duration = 300 μs , duty cycle = 1.5 %.

RESISTIVE SWITCHING TIMES

S G S-THOMSON

30E D

Symbol	Parameter	Test Conditions	Min.	Typ.	Max.	Unit
t_{on}	Turn-on Time	$V_{CC} = 250\text{ V}$ $I_C = 6\text{ A}$ $I_{B1} = -I_{B2} = 1.5\text{ A}$		0.5	1	μs
t_s	Storage Time			1.5	3	μs
t_f	Fall Time			0.2	0.7	μs

INDUCTIVE SWITCHING TIMES

Symbol	Parameter	Test Conditions	Min.	Typ.	Max.	Unit
t_s	Storage Time	$V_{CC} = 250\text{ V}$ $I_C = 6\text{ A}$ $I_{B1} = -I_{B2} = 1.5\text{ A}$		2		μs
t_f	Fall Time			0.15		μs
t_s	Storage Time	$V_{CC} = 250\text{ V}$ $I_C = 6\text{ A}$ $I_{B1} = -I_{B2} = 1.5\text{ A}$ $T_C = 125\text{ °C}$		3	6	μs
t_f	Fall Time			0.33	0.60	μs

7929237 0029003 4

Safe Operating Areas (TO-3).

Safe Operating Areas (TO-218, ISOWATT218).

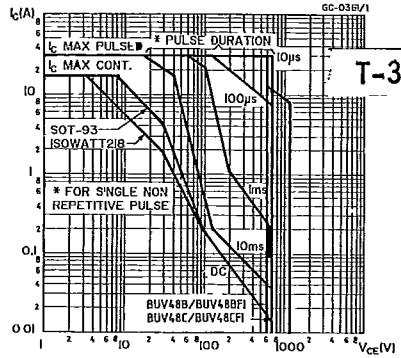
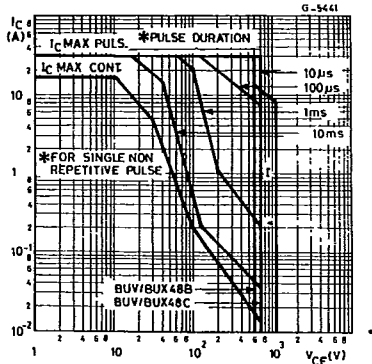

T-33-15

I - Area of permissible operation during turn-on provided $R_{BE} \leq 100 \Omega$ and $t_p \leq 0.2 \mu s$.

SGS-THOMSON

30E D

DC Current Gain.

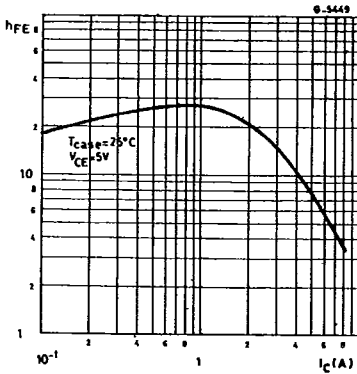

Collector-emitter Saturation Voltage.

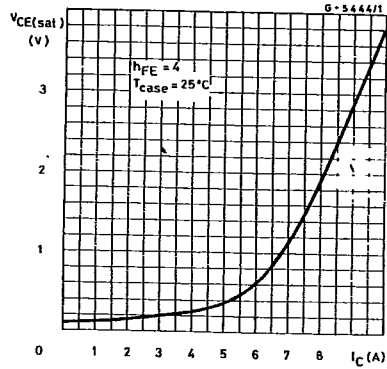

Collector Current Spread vs. Base Emitter Voltage.

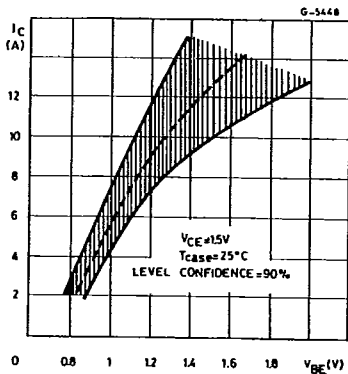

Minimum Bias Current I_{BD} to Saturate the Discrete darlington.

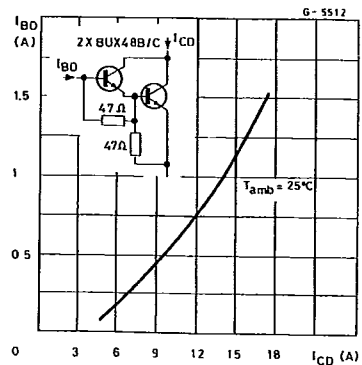

7929237 0029004 6

Minimum Base Current I_{BD} to Saturate the Discrete Darlington.

DC Current Gain for Darlington Configuration (see fig. 1).

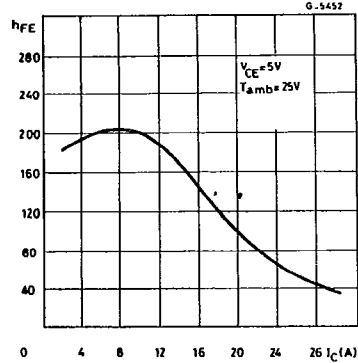
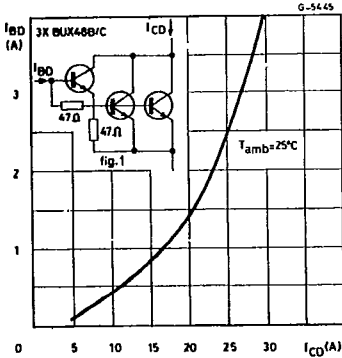

Switching Times Resistive Load.

Switching Times Percentage Variation vs. Case Temperature.

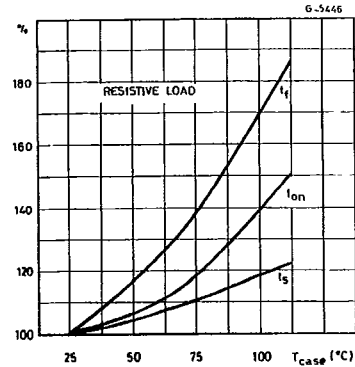
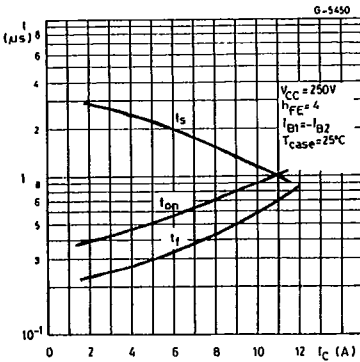

Switching Times Inductive Load.

Switching Times Percentage Variation vs. Case Temperature.

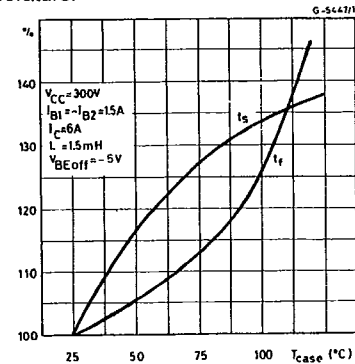
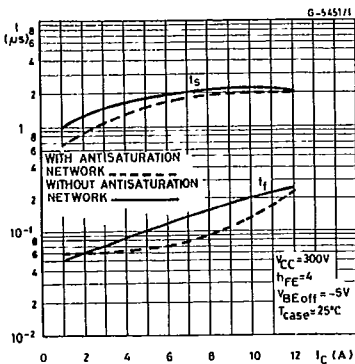

7929237 0029005

T-33-15

Forward Biased Accidental Overload Area.

Clamped Reverse Biased Safe Operating.

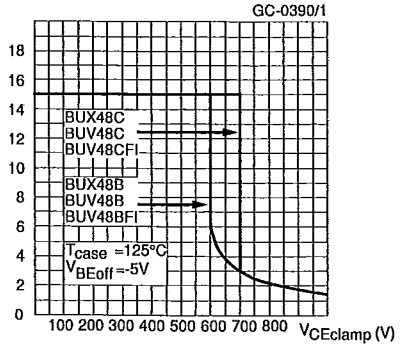
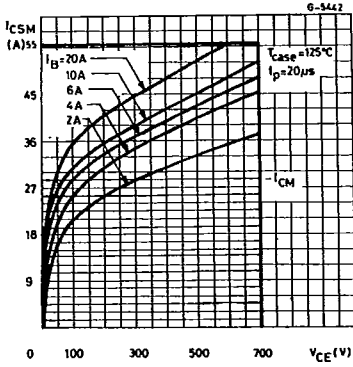

TEST CIRCUITS

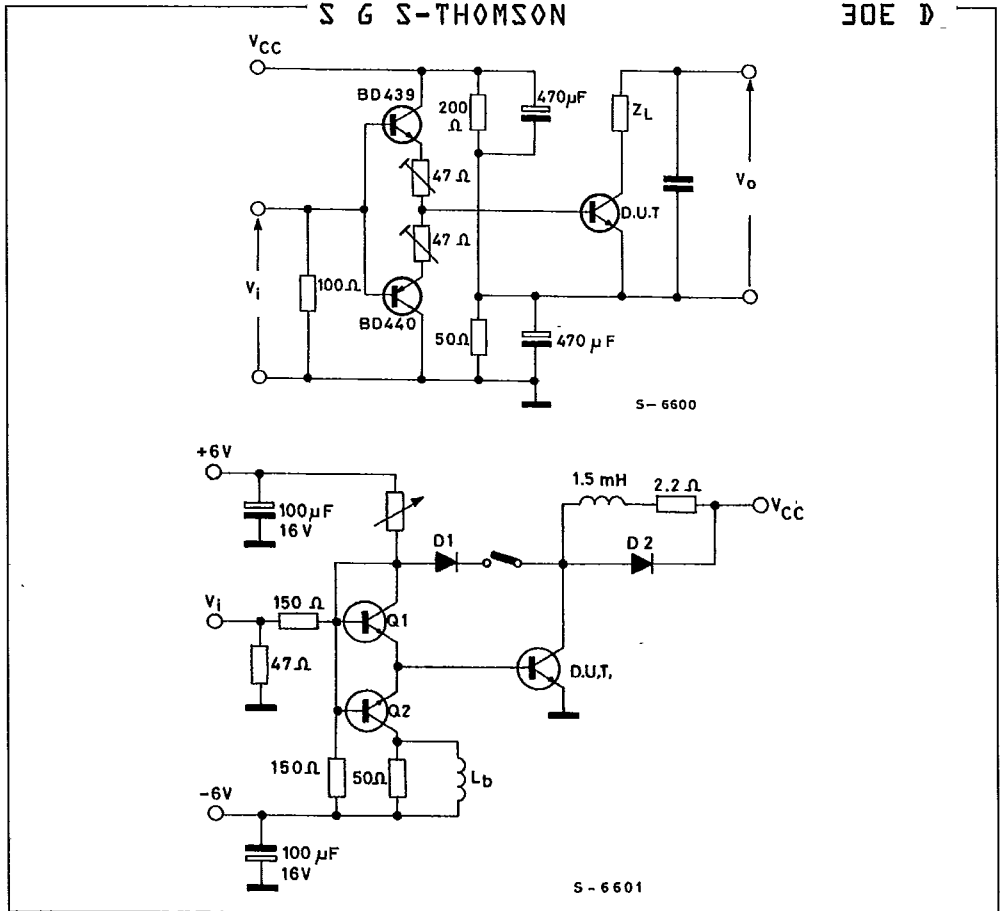

ISOWATT218 PACKAGE CHARACTERISTICS AND APPLICATION

ISOWATT218 is fully isolated to 4000V dc. Its thermal impedance, given in the data sheet, is optimized to give efficient thermal conduction together with excellent electrical isolation. The structure of the case ensures optimum distances between the pins and heatsink. These distances are in agreement with VDE and UL creepage and clearance standards. The ISOWATT218 package eliminates the need for external isolation so reducing fixing hardware.

The package is supplied with leads longer than the standard TO-218 to allow easy mounting on pcbs.

Accurate moulding techniques used in manufacture assures consistent heat spreader-to-heatsink capacitance.

ISOWATT218 thermal performance is equivalent to that of the standard part, mounted with a 0.1mm mica washer. The thermally conductive plastic has a higher breakdown rating and is less fragile than mica or plastic sheets. Power derating for ISOWATT218 packages is determined by :

$$P_D = \frac{T_J - T_C}{R_{th}}$$

THERMAL IMPEDANCE OF ISOWATT218 PACKAGE

Figure 1 illustrates the elements contributing to the thermal resistance of a transistor heatsink assembly, using ISOWATT218 package.

The total thermal resistance $R_{th(total)}$ is the sum of each of these elements. The transient thermal impedance, Z_{th} for different pulse durations can be estimated as follows :

1 - For a short duration power pulse of less than 1ms :

$$Z_{th} < R_{thJ-C}$$

2 - For an intermediate power pulse of 5ms to 50ms seconds :

$$Z_{th} = R_{thJ-C}$$

3 - For long power pulses of the order of 500ms seconds or greater :

$$Z_{th} = R_{thJ-C} + R_{thC-HS} + R_{thHS-amb}$$

It is often possible to discern these areas on transient thermal impedance curves.

Figure 1.

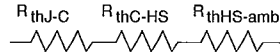

SGS-THOMSON

30E D