

DATA SHEET

BFG541 NPN 9 GHz wideband transistor

Product specification
File under Discrete Semiconductors, SC14

September 1995

NPN 9 GHz wideband transistor

BFG541

FEATURES

- High power gain
- Low noise figure
- High transition frequency
- Gold metallization ensures excellent reliability.

PINNING

PIN	DESCRIPTION
1	emitter
2	base
3	emitter
4	collector

DESCRIPTION

NPN silicon planar epitaxial transistor, intended for wideband applications in the GHz range, such as analog and digital cellular telephones, cordless telephones (CT1, CT2, DECT, etc.), radar detectors, satellite TV tuners (SATV), MATV/CATV amplifiers and repeater amplifiers in fibre-optic systems.

The transistors are mounted in a plastic SOT223 envelope.

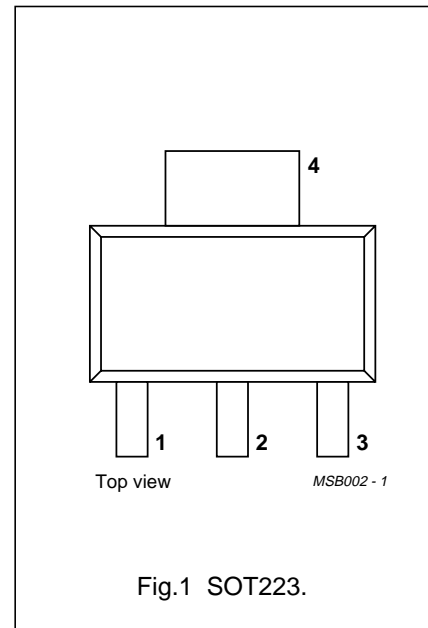

NPN 9 GHz wideband transistor

BFG541

QUICK REFERENCE DATA

SYMBOL	PARAMETER	CONDITIONS	MIN.	TYP.	MAX.	UNIT
V _{CBO}	collector-base voltage	open emitter	–	–	20	V
V _{CES}	collector-emitter voltage	R _{BE} = 0	–	–	15	V
I _C	DC collector current		–	–	120	mA
P _{tot}	total power dissipation	up to T _s = 140 °C; note 1	–	–	650	mW
h _{FE}	DC current gain	I _C = 40 mA; V _{CE} = 8 V; T _j = 25 °C	60	120	250	
C _{re}	feedback capacitance	I _C = 0; V _{CB} = 8 V; f = 1 MHz	–	0.7	–	pF
f _T	transition frequency	I _C = 40 mA; V _{CE} = 8 V; f = 1 GHz; T _{amb} = 25 °C	–	9	–	GHz
G _{UM}	maximum unilateral power gain	I _C = 40 mA; V _{CE} = 8 V; f = 900 MHz; T _{amb} = 25 °C	–	15	–	dB
		I _C = 40 mA; V _{CE} = 8 V; f = 2 GHz; T _{amb} = 25 °C	–	9	–	dB
S ₂₁ ²	insertion power gain	I _C = 40 mA; V _{CE} = 8 V; f = 900 MHz; T _{amb} = 25 °C	13	14	–	dB
F	noise figure	Γ _s = Γ _{opt} ; I _C = 10 mA; V _{CE} = 8 V; f = 900 MHz; T _{amb} = 25 °C	–	1.3	1.8	dB
P _{L1}	output power at 1 dB gain compression	I _C = 40 mA; V _{CE} = 8 V; R _L = 50 Ω; f = 900 MHz; T _{amb} = 25 °C	–	21	–	dBm
ITO	third order intercept point	I _C = 40 mA; V _{CE} = 8 V; R _L = 50 Ω; f = 900 MHz; T _{amb} = 25 °C	–	34	–	dBm

LIMITING VALUES

In accordance with the Absolute Maximum System (IEC 134).

SYMBOL	PARAMETER	CONDITIONS	MIN.	MAX.	UNIT
V _{CBO}	collector-base voltage	open emitter	–	20	V
V _{CES}	collector-emitter voltage	R _{BE} = 0	–	15	V
V _{EBO}	emitter-base voltage	open collector	–	2.5	V
I _C	DC collector current		–	120	mA
P _{tot}	total power dissipation	up to T _s = 140 °C; note 1	–	650	mW
T _{stg}	storage temperature		–65	150	°C
T _j	junction temperature		–	175	°C

THERMAL RESISTANCE

SYMBOL	PARAMETER	CONDITIONS	THERMAL RESISTANCE
R _{th j-s}	thermal resistance from junction to soldering point	up to T _s = 140 °C; note 1	55 K/W

Note

1. T_s is the temperature at the soldering point of the collector tab.

NPN 9 GHz wideband transistor

BFG541

CHARACTERISTICS

 $T_j = 25\text{ °C}$ unless otherwise specified.

SYMBOL	PARAMETER	CONDITIONS	MIN.	TYP.	MAX.	UNIT
I_{CBO}	collector cut-off current	$I_E = 0; V_{CB} = 8\text{ V}$	–	–	50	nA
h_{FE}	DC current gain	$I_C = 40\text{ mA}; V_{CE} = 8\text{ V}$	60	120	250	
C_e	emitter capacitance	$I_C = i_c = 0; V_{EB} = 0.5\text{ V}; f = 1\text{ MHz}$	–	2	–	pF
C_c	collector capacitance	$I_E = i_e = 0; V_{CB} = 8\text{ V}; f = 1\text{ MHz}$	–	1	–	pF
C_{re}	feedback capacitance	$I_C = 0; V_{CB} = 8\text{ V}; f = 1\text{ MHz}$	–	0.7	–	pF
f_T	transition frequency	$I_C = 40\text{ mA}; V_{CE} = 8\text{ V}; f = 1\text{ GHz}; T_{amb} = 25\text{ °C}$	–	9	–	GHz
G_{UM}	maximum unilateral power gain (note 1)	$I_C = 40\text{ mA}; V_{CE} = 8\text{ V}; f = 900\text{ MHz}; T_{amb} = 25\text{ °C}$	–	15	–	dB
		$I_C = 40\text{ mA}; V_{CE} = 8\text{ V}; f = 2\text{ GHz}; T_{amb} = 25\text{ °C}$	–	9	–	dB
$ S_{21} ^2$	insertion power gain	$I_C = 40\text{ mA}; V_{CE} = 8\text{ V}; f = 900\text{ MHz}; T_{amb} = 25\text{ °C}$	13	14	–	dB
F	noise figure	$\Gamma_s = \Gamma_{opt}; I_C = 10\text{ mA}; V_{CE} = 8\text{ V}; f = 900\text{ MHz}; T_{amb} = 25\text{ °C}$	–	1.3	1.8	dB
		$\Gamma_s = \Gamma_{opt}; I_C = 40\text{ mA}; V_{CE} = 8\text{ V}; f = 900\text{ MHz}; T_{amb} = 25\text{ °C}$	–	1.9	2.4	dB
		$\Gamma_s = \Gamma_{opt}; I_C = 10\text{ mA}; V_{CE} = 8\text{ V}; f = 2\text{ GHz}; T_{amb} = 25\text{ °C}$	–	2.1	–	dB
P_{L1}	output power at 1 dB gain compression	$I_C = 40\text{ mA}; V_{CE} = 8\text{ V}; R_L = 50\text{ }\Omega; f = 900\text{ MHz}; T_{amb} = 25\text{ °C}$	–	21	–	dBm
ITO	third order intercept point	note 2	–	34	–	dBm
V_o	output voltage	note 3	–	500	–	mV
d_2	second order intermodulation distortion	note 4	–	–50	–	dB

Notes

1. G_{UM} is the maximum unilateral power gain, assuming S_{12} is zero and

$$G_{UM} = 10 \log \frac{|S_{21}|^2}{(1 - |S_{11}|^2)(1 - |S_{22}|^2)} \text{ dB.}$$

2. $I_C = 40\text{ mA}; V_{CE} = 8\text{ V}; R_L = 50\text{ }\Omega; f = 900\text{ MHz}; T_{amb} = 25\text{ °C};$
 $f_p = 900\text{ MHz}; f_q = 902\text{ MHz};$
 measured at $f_{(2p-q)} = 898\text{ MHz}$ and at $f_{(2p-q)} = 904\text{ MHz}.$
3. $d_{im} = -60\text{ dB (DIN 45004B)}; I_C = 40\text{ mA}; V_{CE} = 8\text{ V}; Z_L = Z_s = 75\text{ }\Omega; T_{amb} = 25\text{ °C};$
 $V_p = V_o; V_q = V_o - 6\text{ dB}; V_r = V_o - 6\text{ dB};$
 $f_p = 795.25\text{ MHz}; f_q = 803.25\text{ MHz}; f_r = 805.25\text{ MHz};$
 measured at $f_{(p+q-r)} = 793.25\text{ MHz}$
4. $I_C = 40\text{ mA}; V_{CE} = 8\text{ V}; V_o = 325\text{ mV}; T_{amb} = 25\text{ °C};$
 $f_p = 250\text{ MHz}; f_q = 560\text{ MHz};$
 measured at $f_{(p+q)} = 810\text{ MHz}$

NPN 9 GHz wideband transistor

BFG541

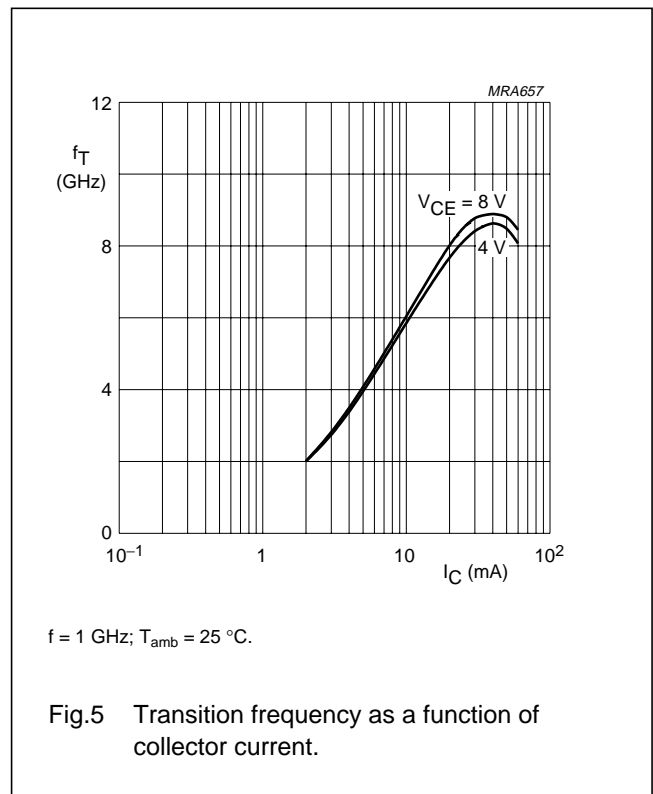
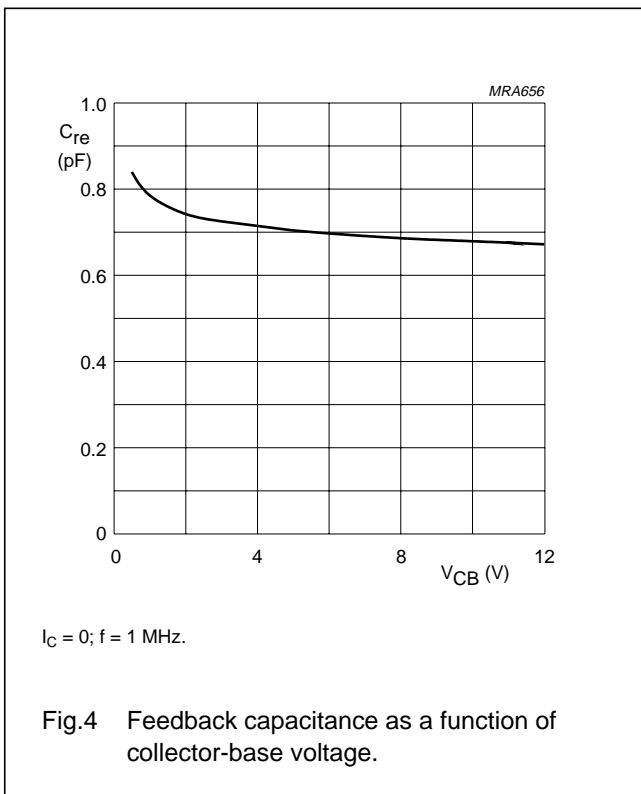
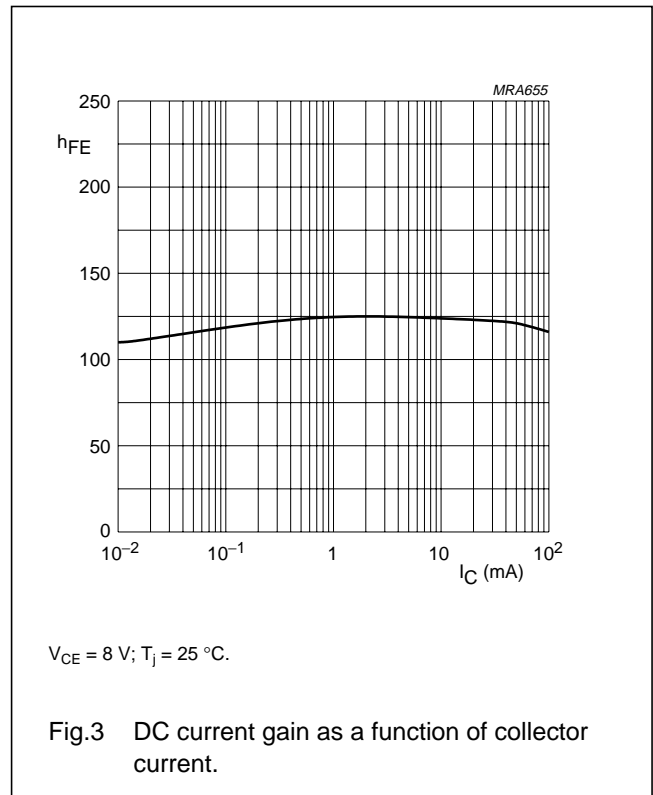
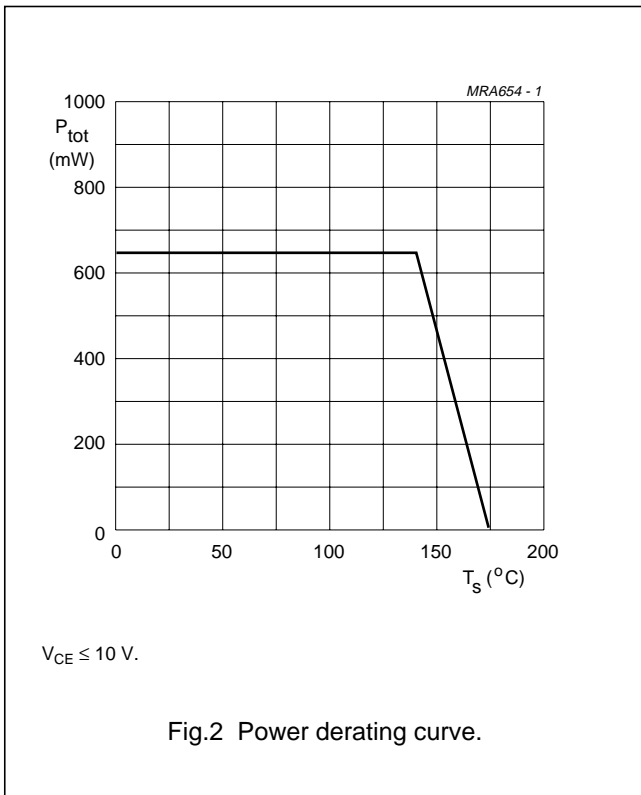

NPN 9 GHz wideband transistor

BFG541

In Figs 6 to 9, G_{UM} = maximum power gain; MSG = maximum stable gain; G_{max} = maximum available gain.

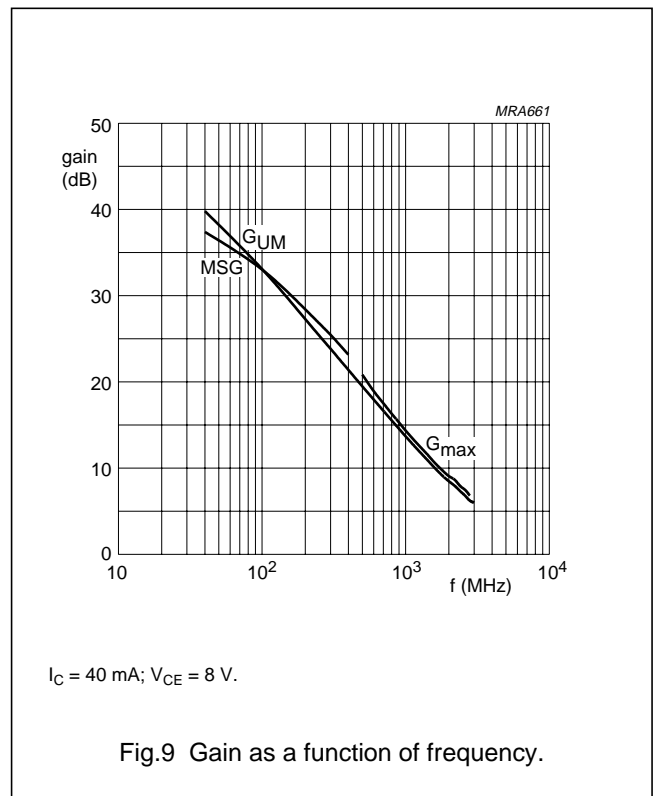
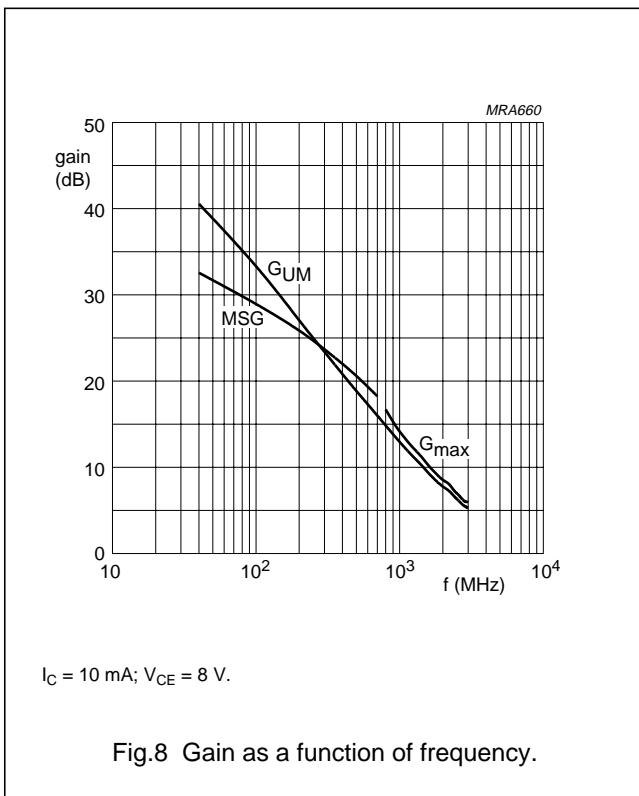
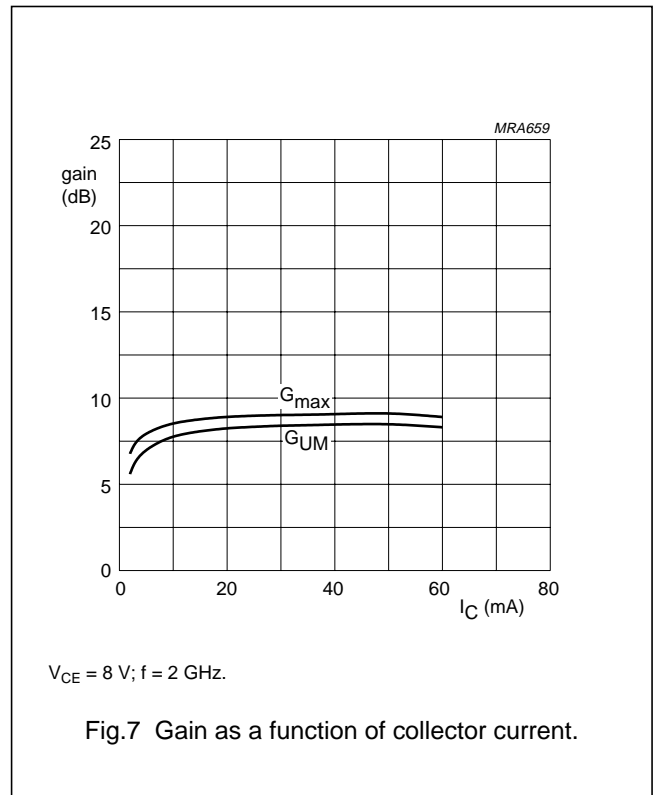
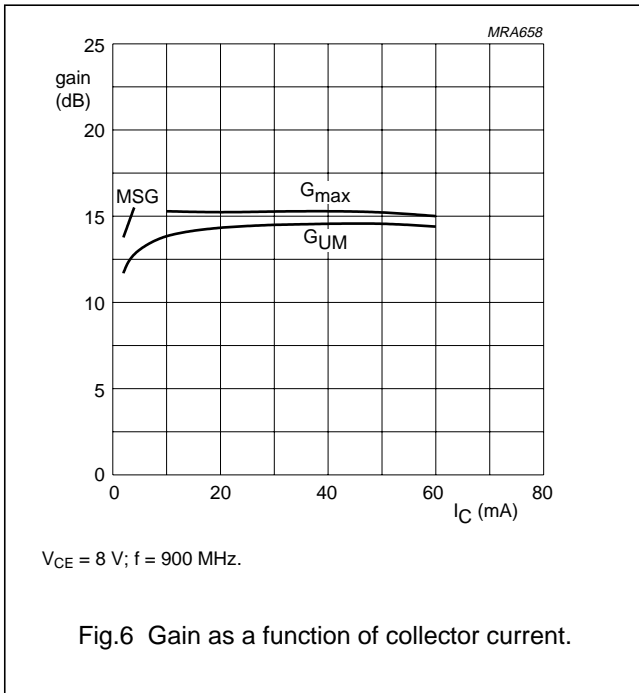

NPN 9 GHz wideband transistor

BFG541

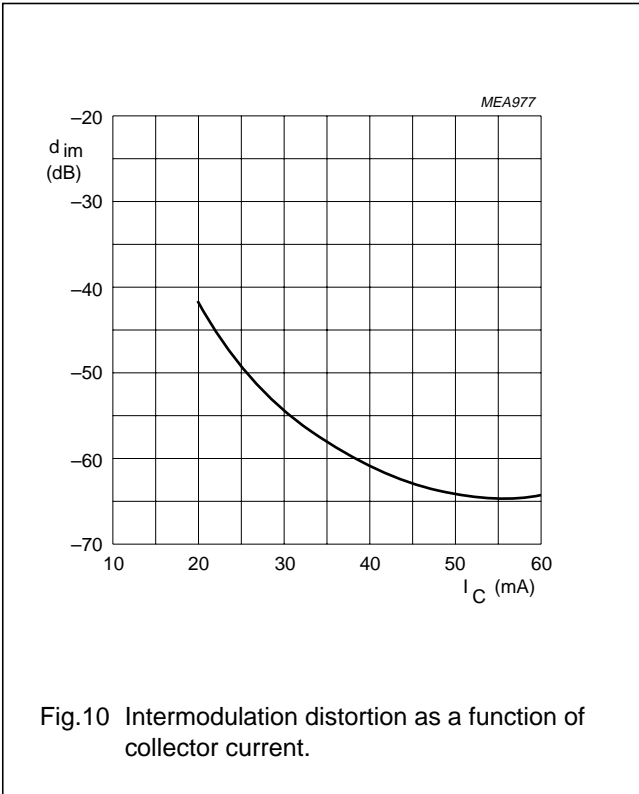

Fig.10 Intermodulation distortion as a function of collector current.

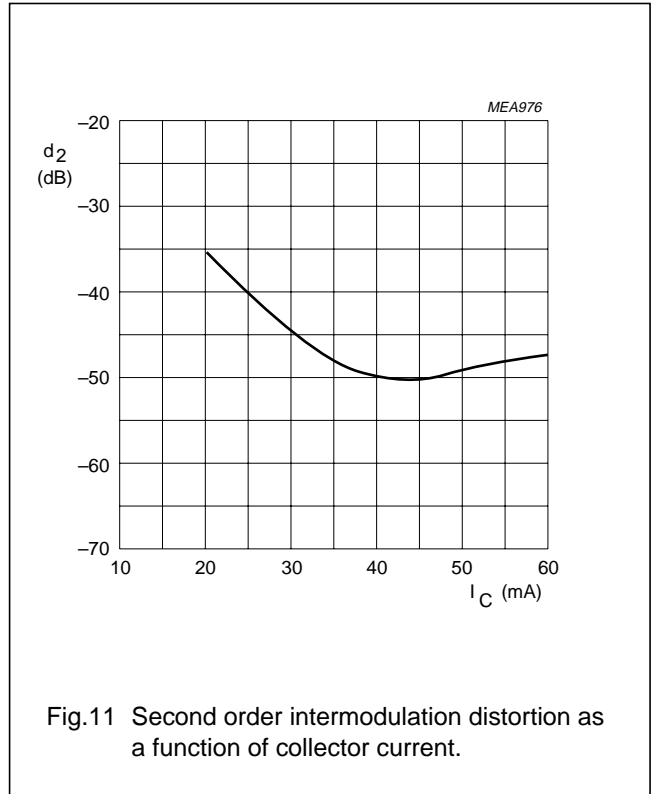
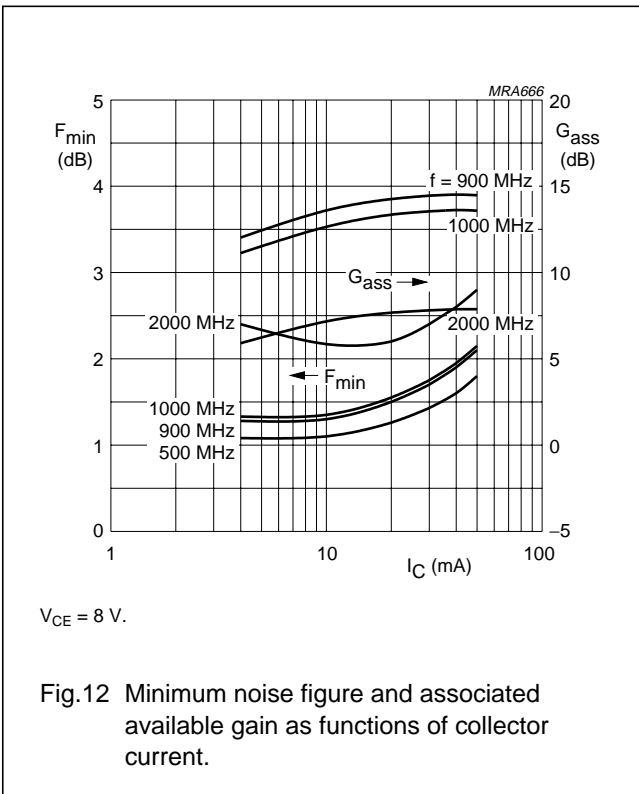
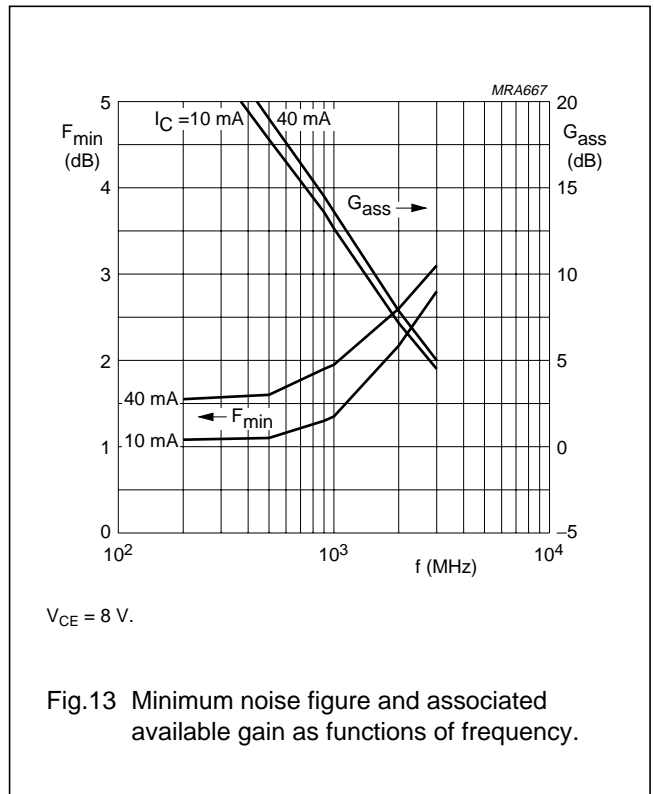

Fig.11 Second order intermodulation distortion as a function of collector current.



$V_{CE} = 8 V.$

Fig.12 Minimum noise figure and associated available gain as functions of collector current.



$V_{CE} = 8 V.$

Fig.13 Minimum noise figure and associated available gain as functions of frequency.

NPN 9 GHz wideband transistor

BFG541

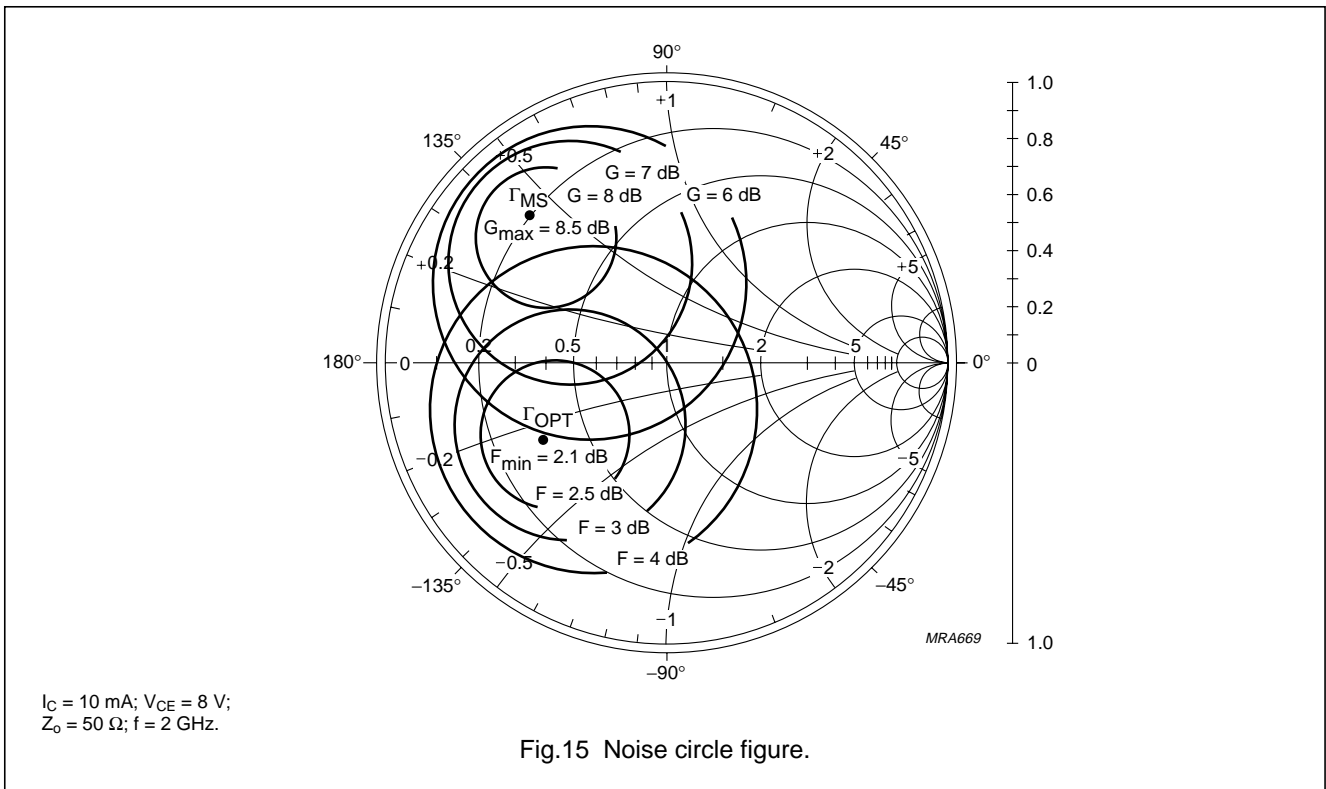
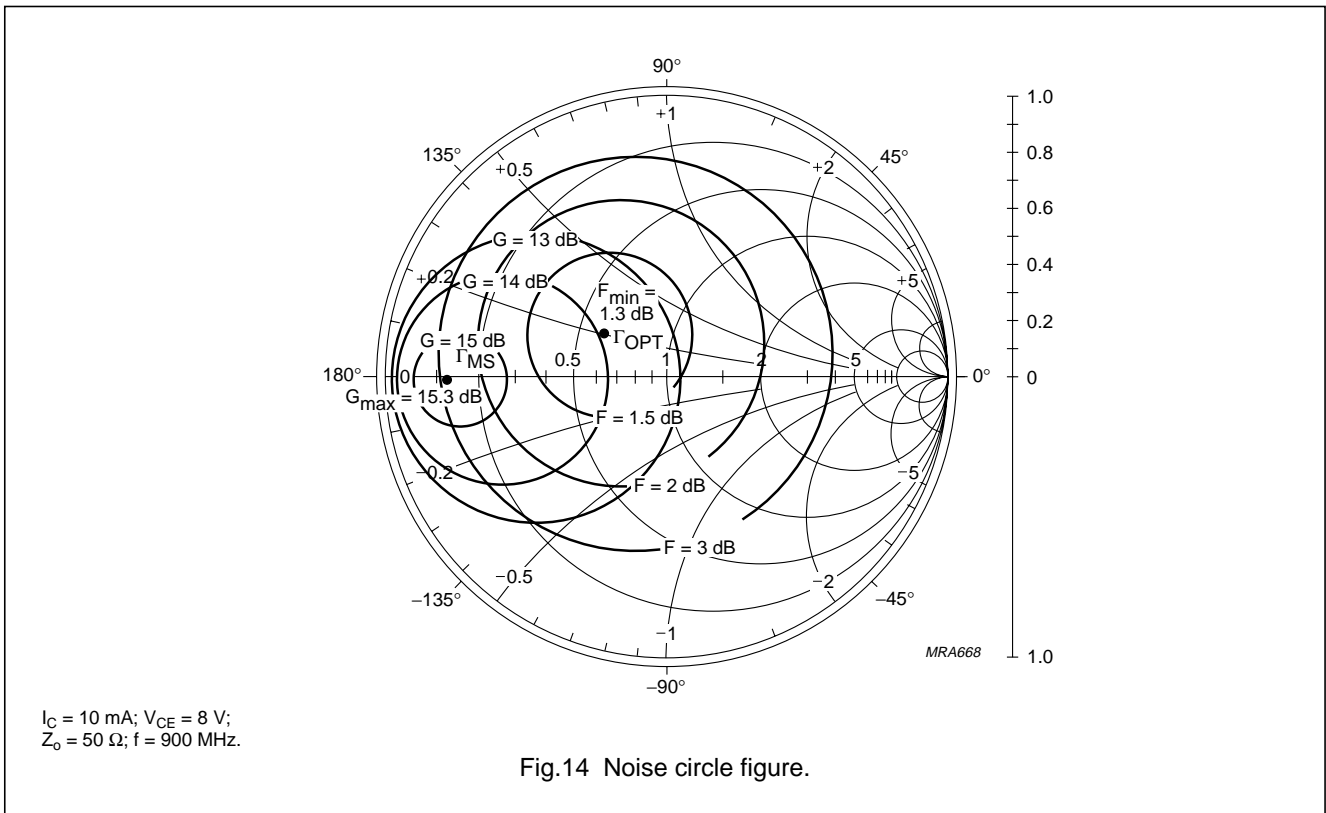

NPN 9 GHz wideband transistor

BFG541

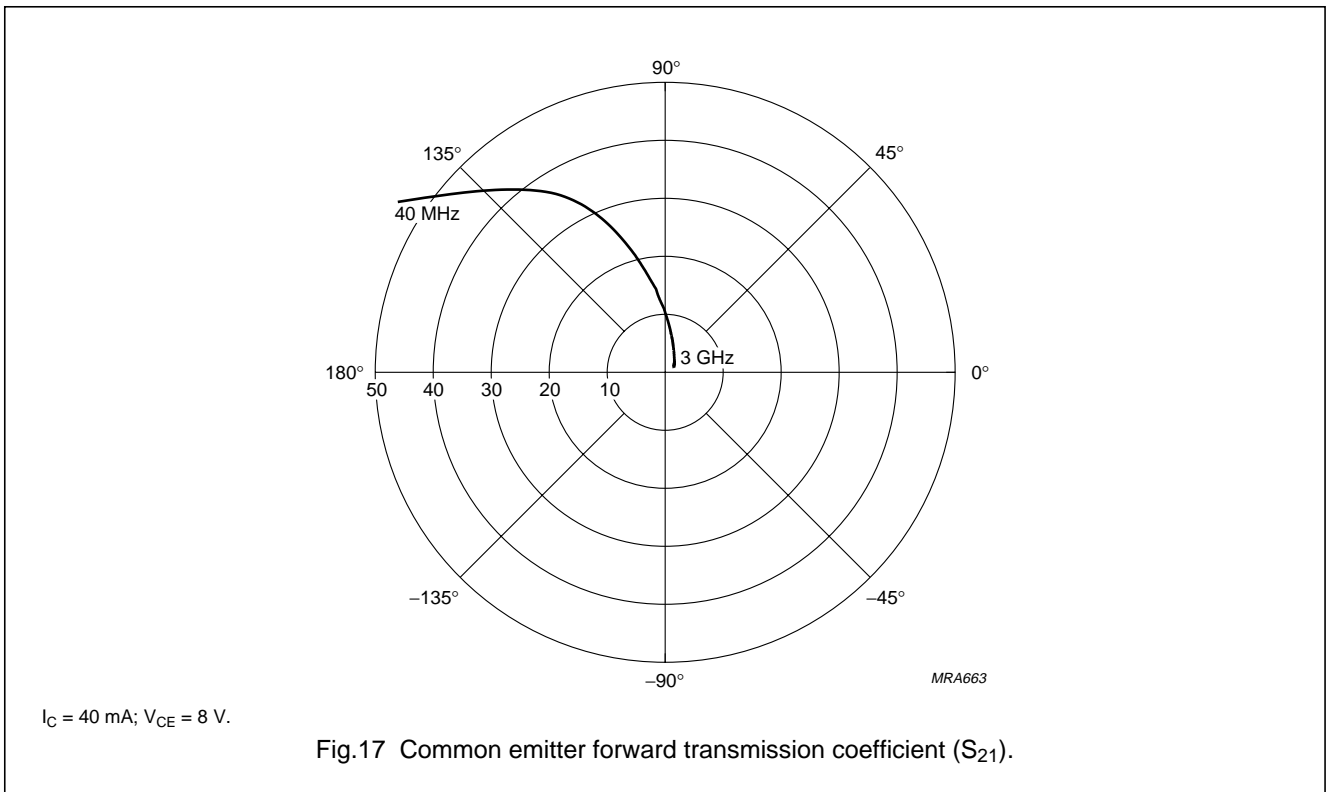
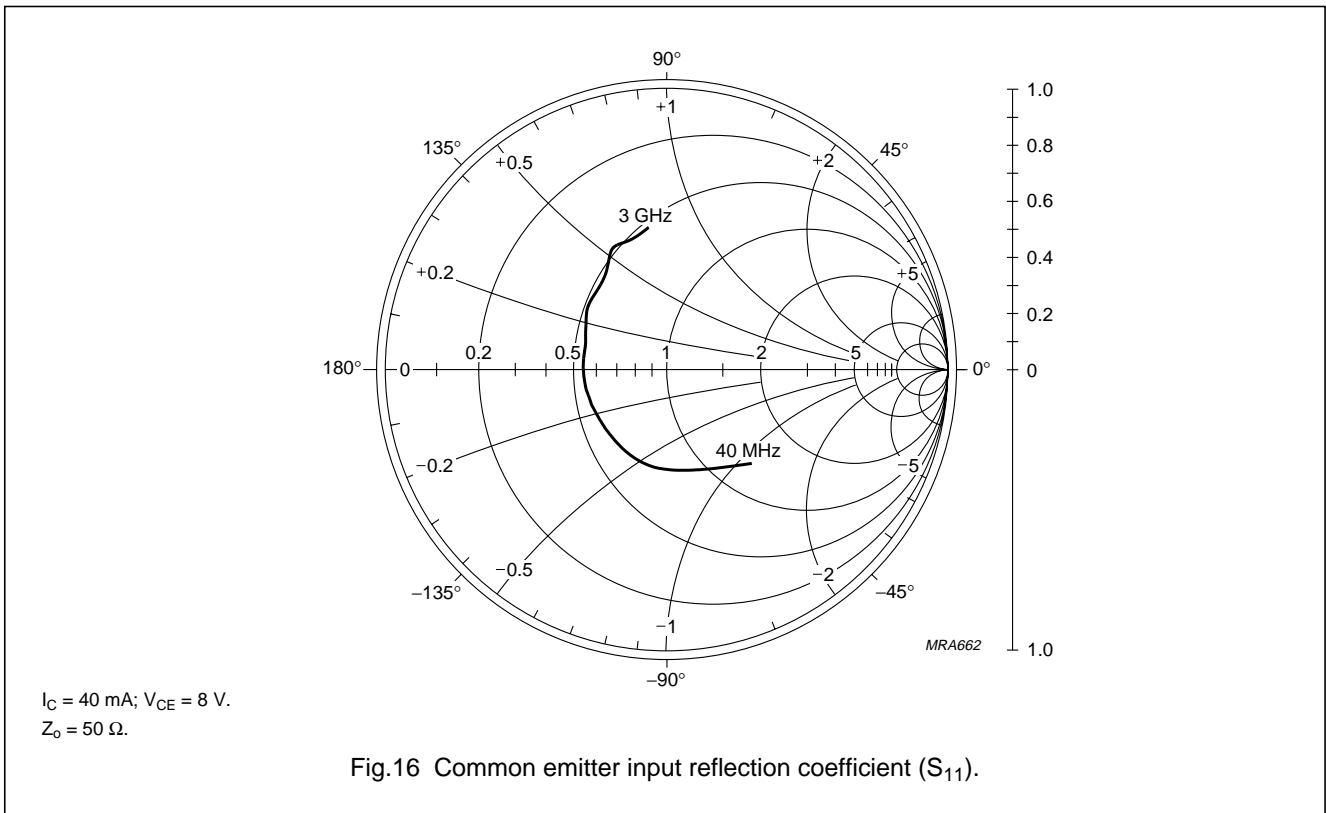

NPN 9 GHz wideband transistor

BFG541

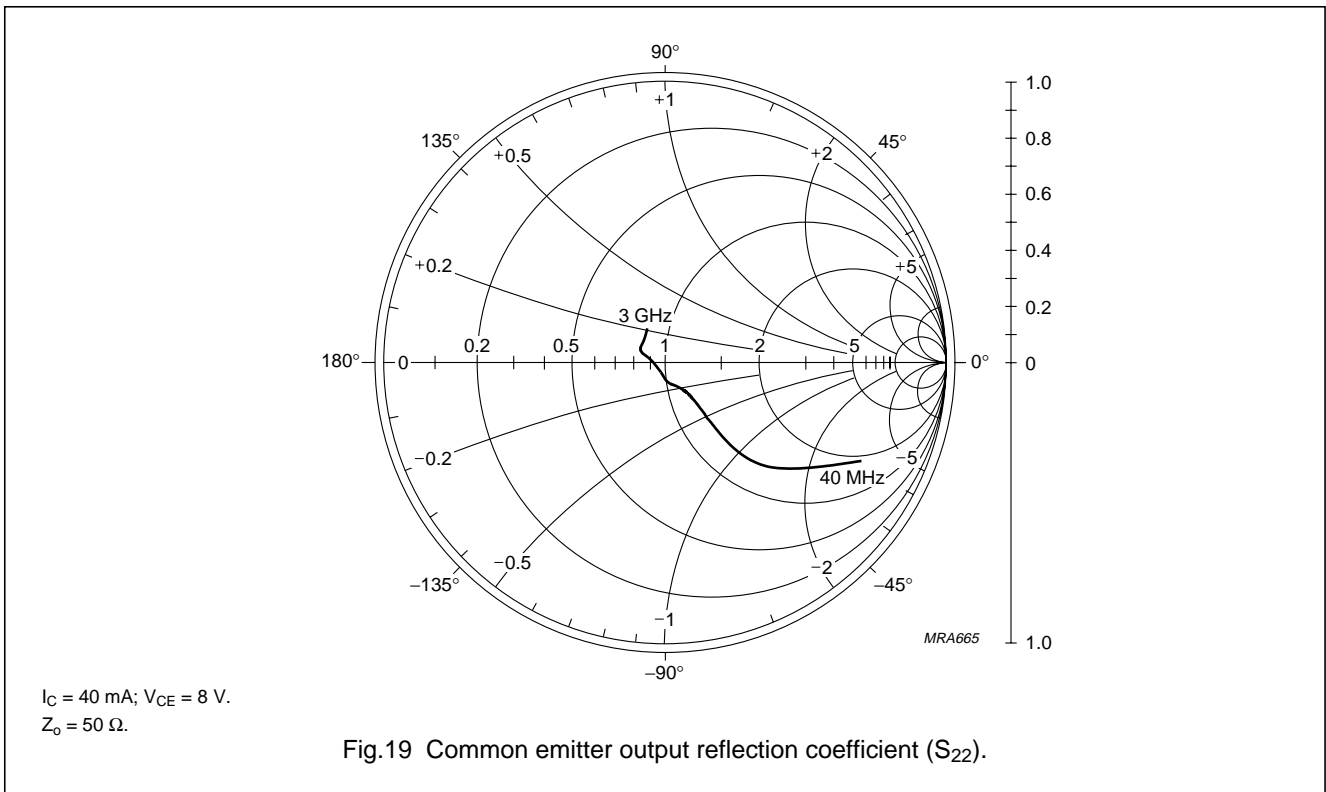
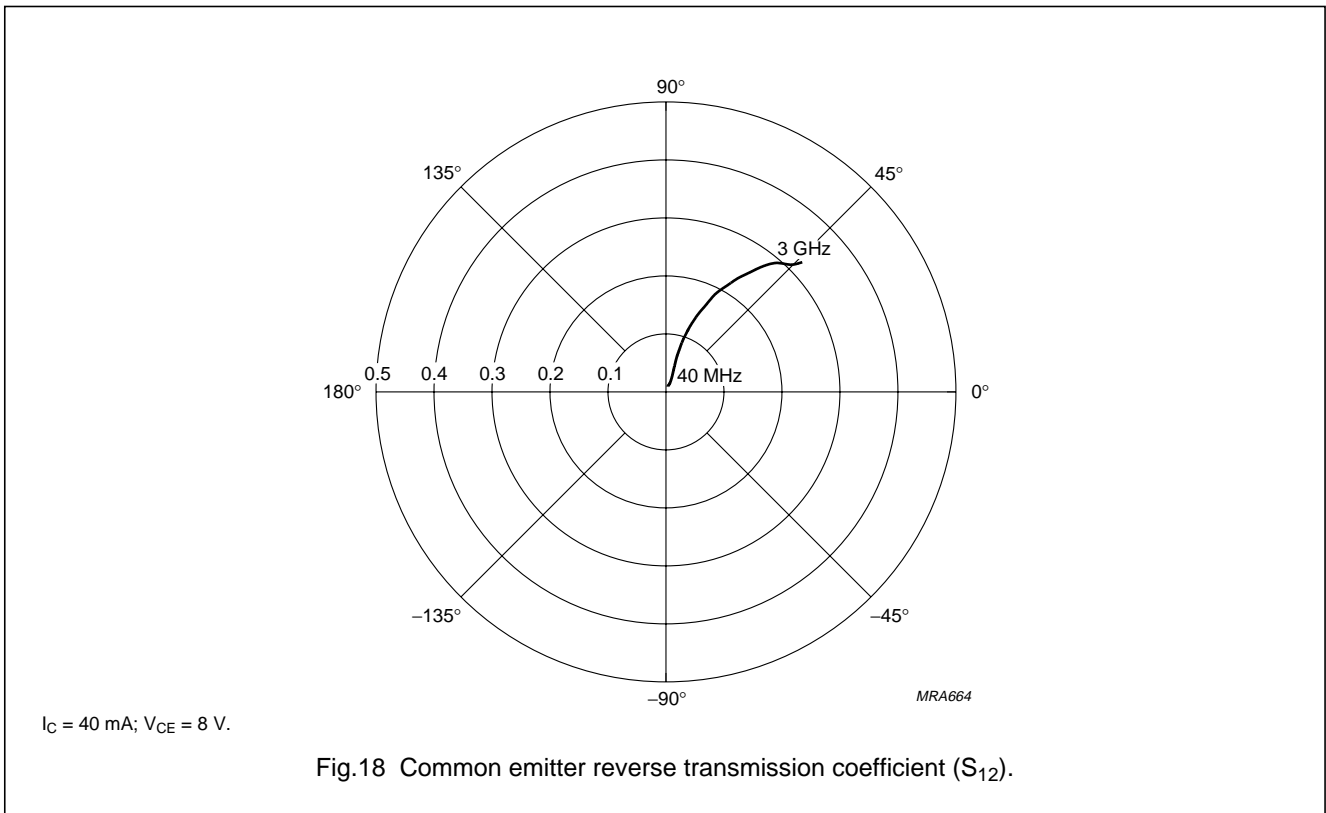

NPN 9 GHz wideband transistor

BFG541

PACKAGE OUTLINE

Plastic surface mounted package; collector pad for good heat transfer; 4 leads

SOT223

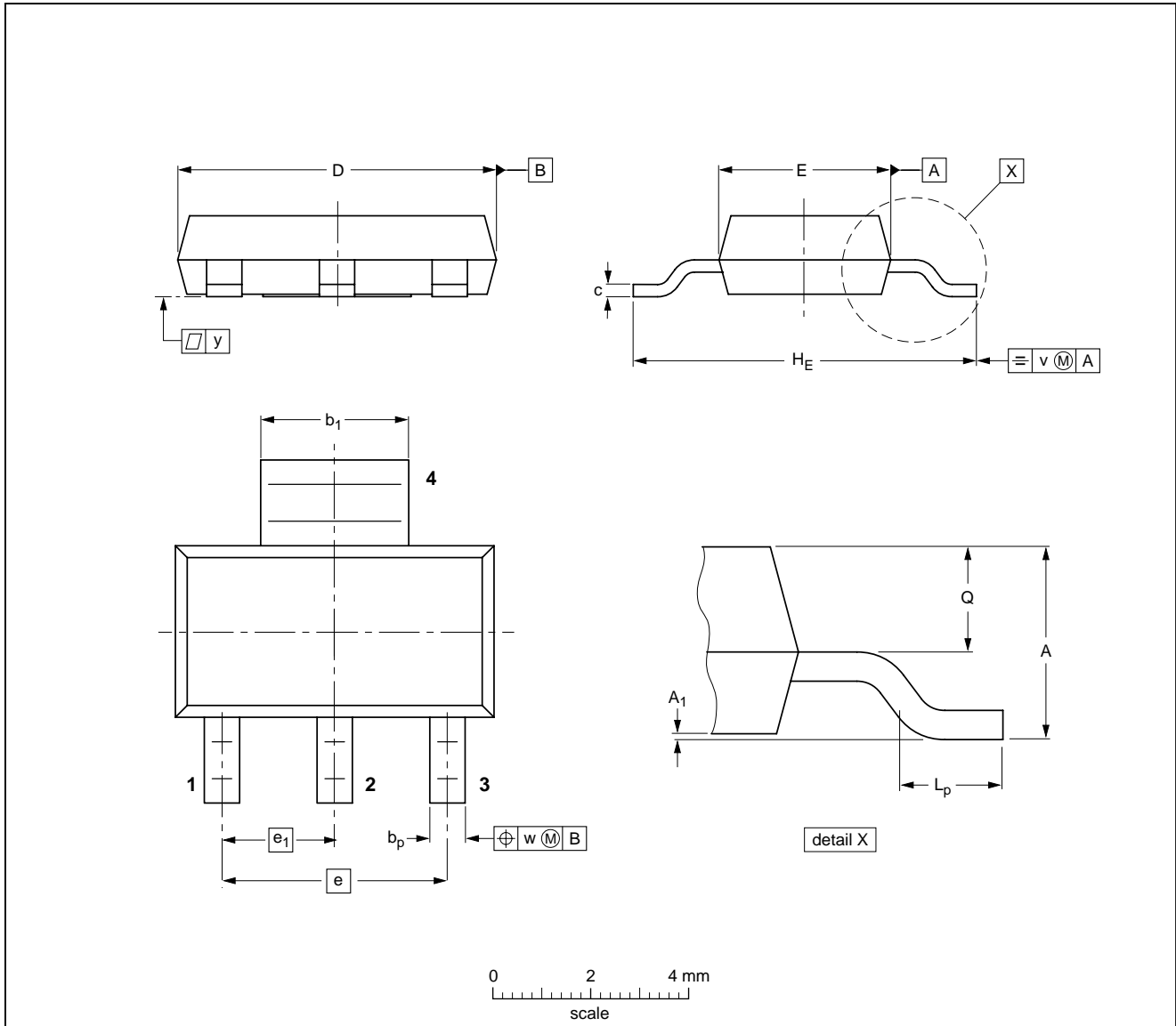

DIMENSIONS (mm are the original dimensions)

UNIT	A	A ₁	b _p	b ₁	c	D	E	e	e ₁	H _E	L _p	Q	v	w	y
mm	1.8 1.5	0.10 0.01	0.80 0.60	3.1 2.9	0.32 0.22	6.7 6.3	3.7 3.3	4.6	2.3	7.3 6.7	1.1 0.7	0.95 0.85	0.2	0.1	0.1

OUTLINE VERSION	REFERENCES				EUROPEAN PROJECTION	ISSUE DATE
	IEC	JEDEC	EIAJ			
SOT223						96-11-11 97-02-28

NPN 9 GHz wideband transistor

BFG541

DEFINITIONS

Data Sheet Status	
Objective specification	This data sheet contains target or goal specifications for product development.
Preliminary specification	This data sheet contains preliminary data; supplementary data may be published later.
Product specification	This data sheet contains final product specifications.
Limiting values	
Limiting values given are in accordance with the Absolute Maximum Rating System (IEC 134). Stress above one or more of the limiting values may cause permanent damage to the device. These are stress ratings only and operation of the device at these or at any other conditions above those given in the Characteristics sections of the specification is not implied. Exposure to limiting values for extended periods may affect device reliability.	
Application information	
Where application information is given, it is advisory and does not form part of the specification.	

LIFE SUPPORT APPLICATIONS

These products are not designed for use in life support appliances, devices, or systems where malfunction of these products can reasonably be expected to result in personal injury. Philips customers using or selling these products for use in such applications do so at their own risk and agree to fully indemnify Philips for any damages resulting from such improper use or sale.