

PNP Silicon AF an Swiching Transistors

- For general AF applications
- High breakdown voltage
- Low collector-emitter saturation voltage
- Complementary types: BCX41, BSS64 (NPN)

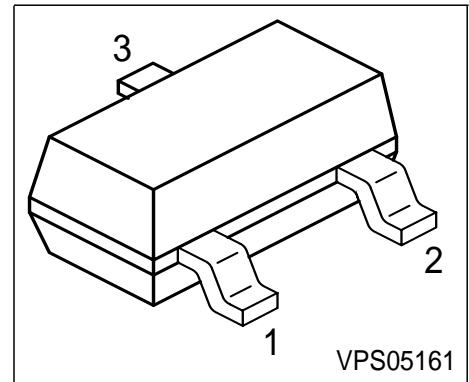

Type	Marking	Pin Configuration			Package
BCX42	DKs	1 = B	2 = E	3 = C	SOT23
BSS63	BMs	1 = B	2 = E	3 = C	SOT23

Maximum Ratings

Parameter	Symbol	BSS63	BCX42	Unit
Collector-emitter voltage	V_{CEO}	100	125	V
Collector-base voltage	V_{CBO}	110	125	
Emitter-base voltage	V_{EBO}	5	5	
DC collector current	I_C	800		mA
Peak collector current	I_{CM}	1		A
Base current	I_B	100		mA
Peak base current	I_{BM}	200		
Total power dissipation, $T_S = 79\text{ °C}$	P_{tot}	330		mW
Junction temperature	T_j	150		°C
Storage temperature	T_{stg}	-65 ... 150		

Thermal Resistance

Junction - soldering point ¹⁾	R_{thJS}	≤215	K/W
--	------------	------	-----

¹⁾For calculation of R_{thJA} please refer to Application Note Thermal Resistance

Electrical Characteristics at $T_A = 25^\circ\text{C}$, unless otherwise specified.

Parameter	Symbol	Values			Unit	
		min.	typ.	max.		
DC Characteristics						
Collector-emitter breakdown voltage $I_C = 10\text{ mA}, I_B = 0$	BSS63 BCX42	$V_{(BR)CEO}$	100 125	- -	- -	V
Collector-base breakdown voltage $I_C = 100\ \mu\text{A}, I_B = 0$	BSS63 BCX42	$V_{(BR)CBO}$	110 125	- -	- -	
Emitter-base breakdown voltage $I_E = 10\ \mu\text{A}, I_C = 0$		$V_{(BR)EBO}$	5	-	-	
Collector cutoff current $V_{CB} = 80\text{ V}, I_E = 0$ $V_{CB} = 100\text{ V}, I_E = 0$	BSS63 BCX42	I_{CBO}	- -	- -	100 100	nA
Collector cutoff current $V_{CB} = 80\text{ V}, I_E = 0, T_A = 150\ ^\circ\text{C}$ $V_{CB} = 100\text{ V}, I_E = 0, T_A = 150\ ^\circ\text{C}$	BSS63 BCX42	I_{CBO}	- -	- -	20 20	μA
Emitter cutoff current $V_{EB} = 4\text{ V}, I_C = 0$		I_{EBO}	-	-	100	nA
Collector cutoff current $V_{CE} = 100\text{ V}, T_A = 85\ ^\circ\text{C}$ $V_{CE} = 100\text{ V}, T_A = 125\ ^\circ\text{C}$	BCX42 BCX42	I_{CEO}	- -	- -	10 75	μA
DC current gain 1) $I_C = 100\ \mu\text{A}, V_{CE} = 1\text{ V}$ $I_C = 10\text{ mA}, V_{CE} = 5\text{ V}$ $I_C = 20\text{ mA}, V_{CE} = 5\text{ V}$ $I_C = 100\text{ mA}, V_{CE} = 1\text{ V}$ $I_C = 200\text{ mA}, V_{CE} = 1\text{ V}$	BCX42 BSS63 BSS63 BCX42 BCX42	h_{FE}	25 30 30 63 40	- - - - -	- - - - -	-

 1) Pulse test: $t \leq 300\ \mu\text{s}$, $D = 2\%$

Electrical Characteristics at $T_A = 25^\circ\text{C}$, unless otherwise specified.

Parameter	Symbol	Values			Unit
		min.	typ.	max.	
DC Characteristics					
Collector-emitter saturation voltage ¹⁾ $I_C = 300\text{ mA}, I_B = 30\text{ mA}$ BCX42	V_{CEsat}	-	-	0.9	V
$I_C = 25\text{ mA}, I_B = 2.5\text{ mA}$ BSS63		-	-	0.25	
$I_C = 75\text{ mA}, I_B = 7.5\text{ mA}$ BSS63		-	-	0.9	
Base-emitter saturation voltage 1) $I_C = 300\text{ mA}, I_B = 30\text{ mA}$ BCX42	V_{BEsat}	-	-	1.4	
AC Characteristics					
Transition frequency $I_C = 20\text{ mA}, V_{CE} = 5\text{ V}, f = 20\text{ MHz}$	f_T	-	150	-	MHz
Collector-base capacitance $V_{CB} = 10\text{ V}, f = 1\text{ MHz}$	C_{cb}	-	12	-	pF

Total power dissipation $P_{tot} = f(T_S)$

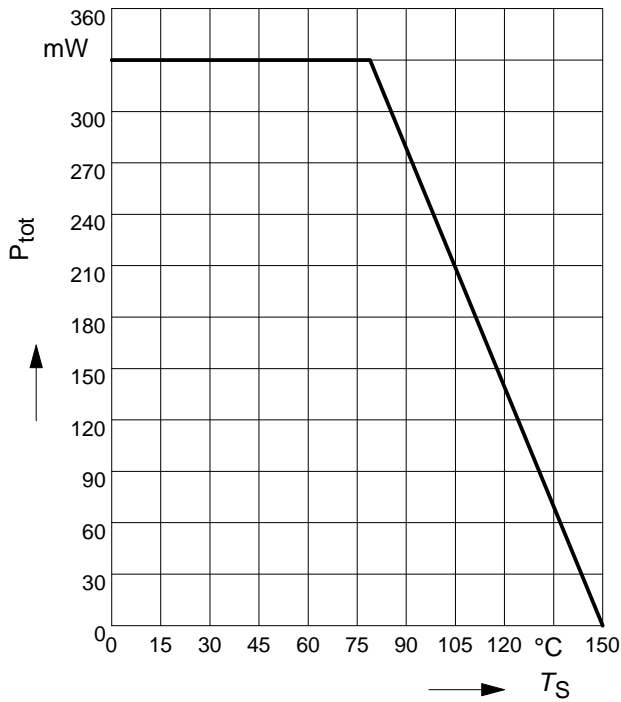

Collector current $I_C = f(V_{BE})$

$V_{CE} = 1V$

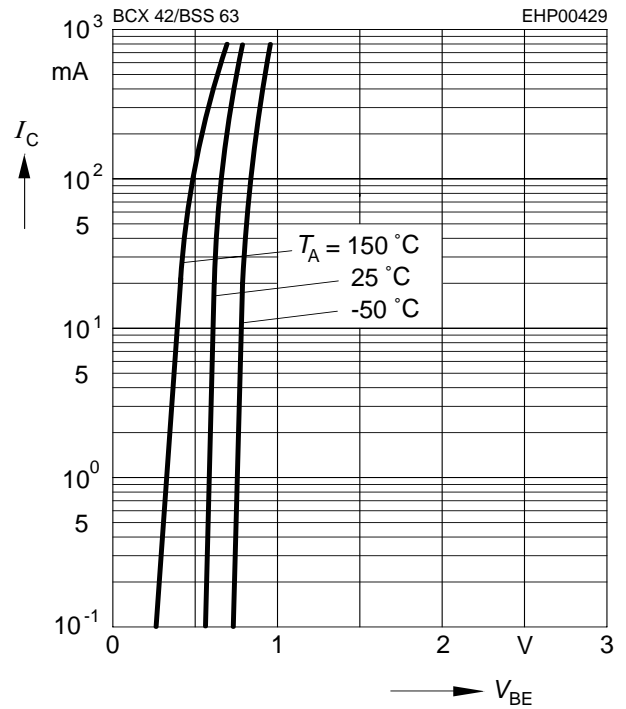

Permissible pulse load

$P_{totmax} / P_{totDC} = f(t_p)$

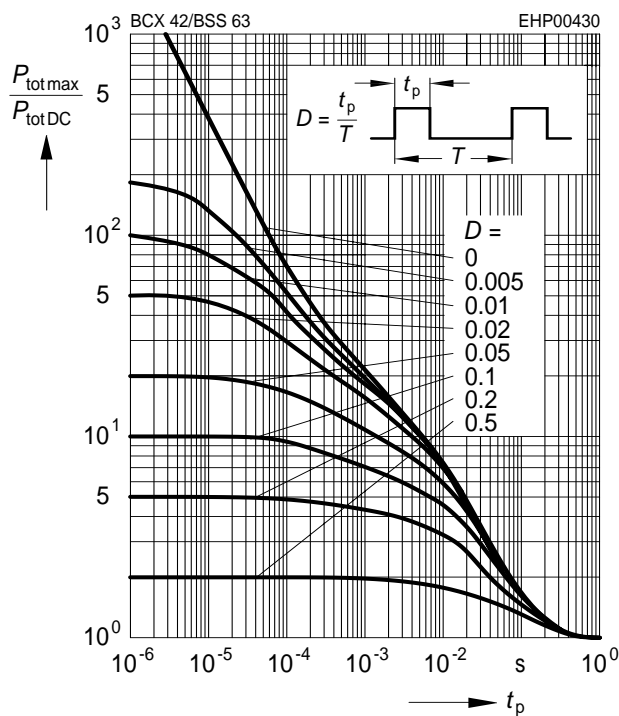

Transition frequency $f_T = f(I_C)$

$V_{CE} = 5V$

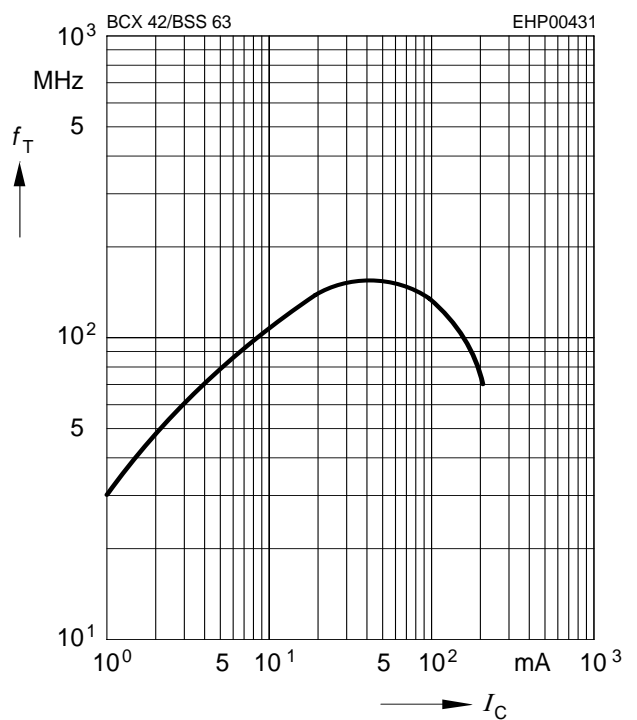

Base-emitter saturation voltage

$I_C = f(V_{BEsat}), h_{FE} = 10$

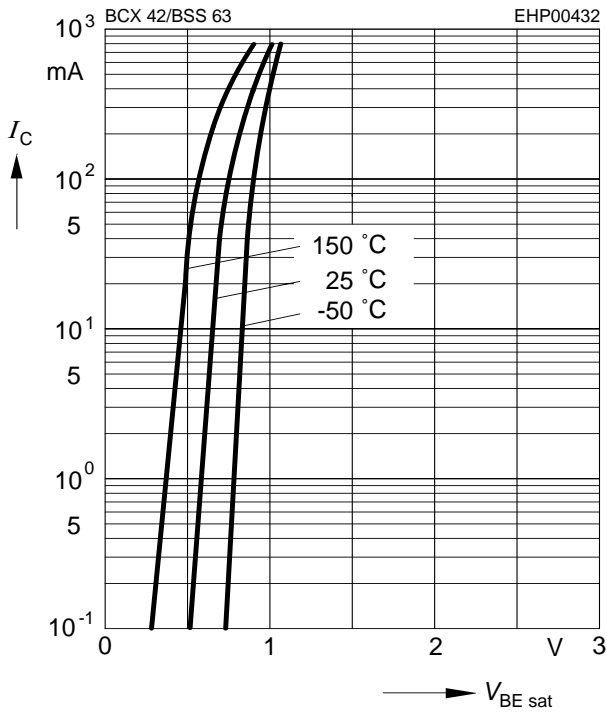

Collector-emitter saturation voltage

$I_C = f(V_{CEsat}), h_{FE} = 10$

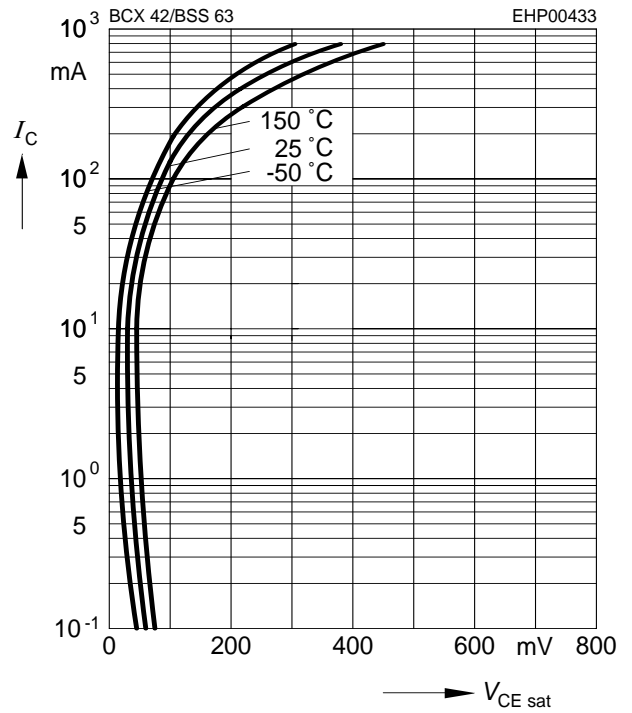

Collector cutoff current $I_{CBO} = f(T_A)$

$V_{CB} = 100V$

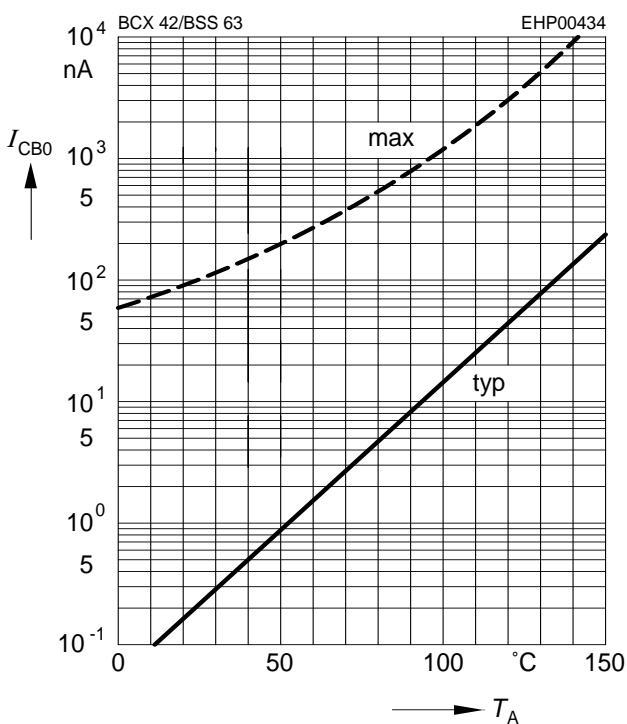

DC current gain $h_{FE} = f(I_C)$

$V_{CE} = 1V$

