

# BC807-16LT1, BC807-25LT1, BC807-40LT1

## General Purpose Transistors

### PNP Silicon

#### Features

- Pb-Free Packages are Available

#### MAXIMUM RATINGS

Rating	Symbol	Value	Unit
Collector - Emitter Voltage	$V_{CEO}$	-45	V
Collector - Base Voltage	$V_{CBO}$	-50	V
Emitter - Base Voltage	$V_{EBO}$	-5.0	V
Collector Current – Continuous	$I_C$	-500	mAdc

Maximum ratings are those values beyond which device damage can occur. Maximum ratings applied to the device are individual stress limit values (not normal operating conditions) and are not valid simultaneously. If these limits are exceeded, device functional operation is not implied, damage may occur and reliability may be affected.

#### THERMAL CHARACTERISTICS

Characteristic	Symbol	Max	Unit
Total Device Dissipation FR-5 Board, (Note 1) $T_A = 25^\circ\text{C}$ Derate above $25^\circ\text{C}$	$P_D$	225 1.8	mW mW/ $^\circ\text{C}$
Thermal Resistance, Junction-to-Ambient	$R_{\theta JA}$	556	$^\circ\text{C}/\text{W}$
Total Device Dissipation Alumina Substrate, (Note 2) $T_A = 25^\circ\text{C}$ Derate above $25^\circ\text{C}$	$P_D$	300 2.4	mW mW/ $^\circ\text{C}$
Thermal Resistance, Junction-to-Ambient	$R_{\theta JA}$	417	$^\circ\text{C}/\text{W}$
Junction and Storage Temperature	$T_J, T_{stg}$	-55 to +150	$^\circ\text{C}$

- FR-5 = 1.0 x 0.75 x 0.062 in.
- Alumina = 0.4 x 0.3 x 0.024 in 99.5% alumina.



ON Semiconductor®

<http://onsemi.com>

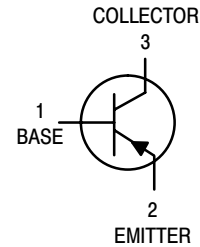

#### MARKING DIAGRAM

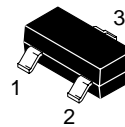

SOT-23  
CASE 318  
STYLE 6

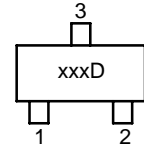

xxx = 5A (BC807-16LT1)  
5B1 (BC807-25LT1)  
5C (BC807-40LT1)  
D = Date Code

#### ORDERING INFORMATION

See detailed ordering and shipping information in the package dimensions section on page 2 of this data sheet.

# BC807-16LT1, BC807-25LT1, BC807-40LT1

## ELECTRICAL CHARACTERISTICS (T<sub>A</sub> = 25°C unless otherwise noted.)

Characteristic	Symbol	Min	Typ	Max	Unit
----------------	--------	-----	-----	-----	------

### OFF CHARACTERISTICS

Collector–Emitter Breakdown Voltage (I <sub>C</sub> = -10 mA)	V <sub>(BR)CEO</sub>	-45	-	-	V
Collector–Emitter Breakdown Voltage (V <sub>EB</sub> = 0, I <sub>C</sub> = -10 μA)	V <sub>(BR)CES</sub>	-50	-	-	V
Emitter–Base Breakdown Voltage (I <sub>E</sub> = -1.0 μA)	V <sub>(BR)EBO</sub>	-5.0	-	-	V
Collector Cutoff Current (V <sub>CB</sub> = -20 V) (V <sub>CB</sub> = -20 V, T <sub>J</sub> = 150°C)	I <sub>CBO</sub>	-	-	-100 -5.0	nA μA

### ON CHARACTERISTICS

DC Current Gain (I <sub>C</sub> = -100 mA, V <sub>CE</sub> = -1.0 V)  (I <sub>C</sub> = -500 mA, V <sub>CE</sub> = -1.0 V)	BC807-16 BC807-25 BC807-40	h <sub>FE</sub>	100 160 250 40	- - - -	250 400 600 -	-
Collector–Emitter Saturation Voltage (I <sub>C</sub> = -500 mA, I <sub>B</sub> = -50 mA)		V <sub>CE(sat)</sub>	-	-	-0.7	V
Base–Emitter On Voltage (I <sub>C</sub> = -500 mA, I <sub>B</sub> = -1.0 V)		V <sub>BE(on)</sub>	-	-	-1.2	V

### SMALL-SIGNAL CHARACTERISTICS

Current–Gain – Bandwidth Product (I <sub>C</sub> = -10 mA, V <sub>CE</sub> = -5.0 Vdc, f = 100 MHz)		f <sub>T</sub>	100	-	-	MHz
Output Capacitance (V <sub>CB</sub> = -10 V, f = 1.0 MHz)		C <sub>obo</sub>	-	10	-0.7	pF

### DEVICE ORDERING INFORMATION

Device	Package	Shipping†
BC807-16LT1	SOT-23	3,000 Tape & Reel
BC807-16LT3	SOT-23	10,000 Tape & Reel
BC807-25LT1	SOT-23	3,000 Tape & Reel
BC807-25LT1G	SOT-23 (Pb-Free)	
BC807-25LT3	SOT-23	10,000 Tape & Reel
BC807-40LT1	SOT-23	3,000 Tape & Reel
BC807-40LT1G	SOT-23 (Pb-Free)	
BC807-40LT3	SOT-23	10,000 Tape & Reel
BC807-40LT3G	SOT-23 (Pb-Free)	

†For information on tape and reel specifications, including part orientation and tape sizes, please refer to our Tape and Reel Packaging Specifications Brochure, BRD8011/D.

BC807-16LT1, BC807-25LT1, BC807-40LT1

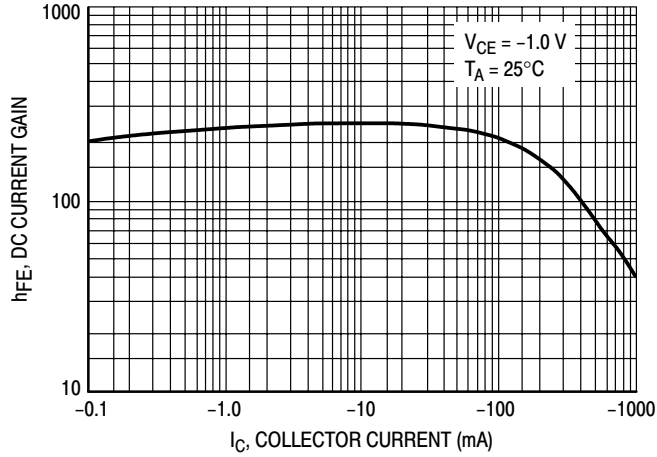

Figure 1. DC Current Gain

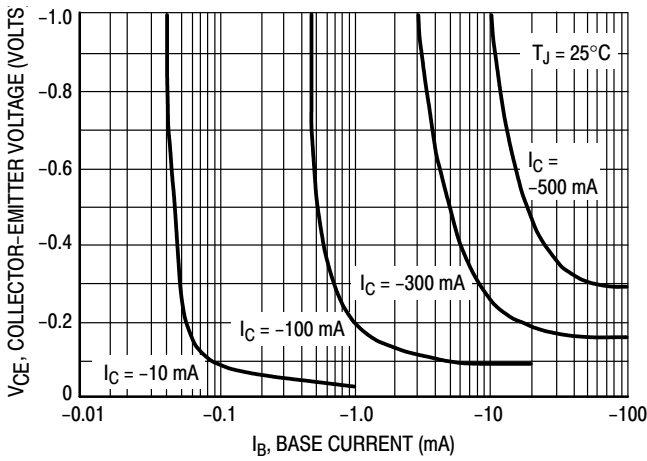

Figure 2. Saturation Region

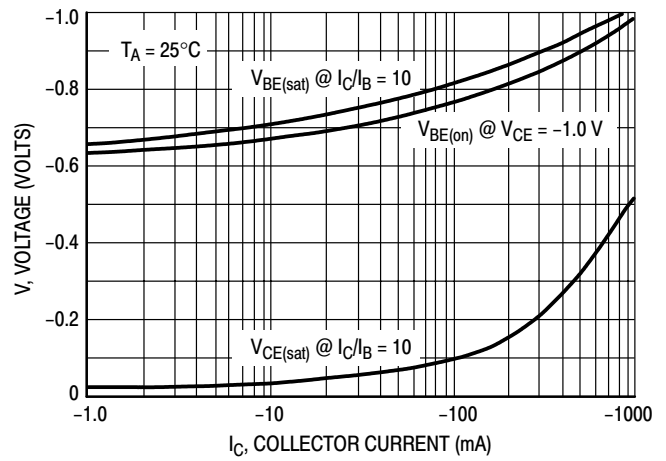

Figure 3. "On" Voltages

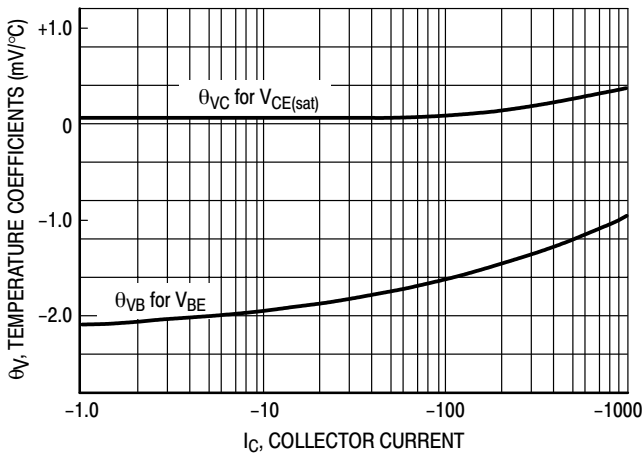

Figure 4. Temperature Coefficients

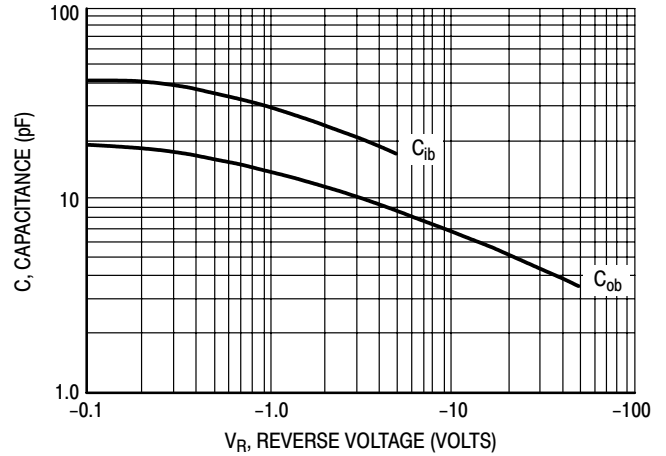
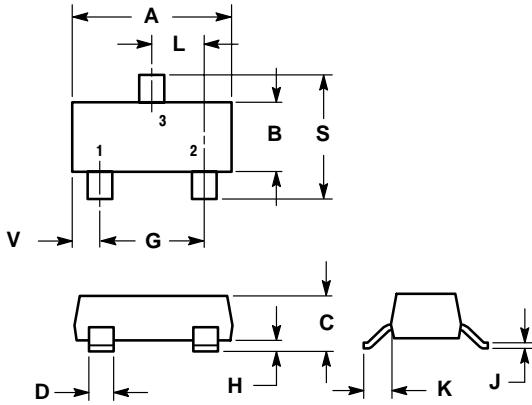

Figure 5. Capacitances

# BC807-16LT1, BC807-25LT1, BC807-40LT1

## PACKAGE DIMENSIONS

### SOT-23 (TO-236) CASE 318-09 ISSUE AI



#### NOTES:

1. DIMENSIONING AND TOLERANCING PER ANSI Y14.5M, 1982.
2. CONTROLLING DIMENSION: INCH.
3. MAXIMUM LEAD THICKNESS INCLUDES LEAD FINISH THICKNESS. MINIMUM LEAD THICKNESS IS THE MINIMUM THICKNESS OF BASE MATERIAL.
4. 318-01, -02, AND -06 OBSOLETE, NEW STANDARD 318-09.

DIM	INCHES		MILLIMETERS	
	MIN	MAX	MIN	MAX
A	0.1102	0.1197	2.80	3.04
B	0.0472	0.0551	1.20	1.40
C	0.0385	0.0498	0.99	1.26
D	0.0140	0.0200	0.36	0.50
G	0.0670	0.0826	1.70	2.10
H	0.0040	0.0098	0.10	0.25
J	0.0034	0.0070	0.085	0.177
K	0.0180	0.0236	0.45	0.60
L	0.0350	0.0401	0.89	1.02
S	0.0830	0.0984	2.10	2.50
V	0.0177	0.0236	0.45	0.60

#### STYLE 6:

1. BASE
2. EMITTER
3. COLLECTOR

### SOLDERING FOOTPRINT\*

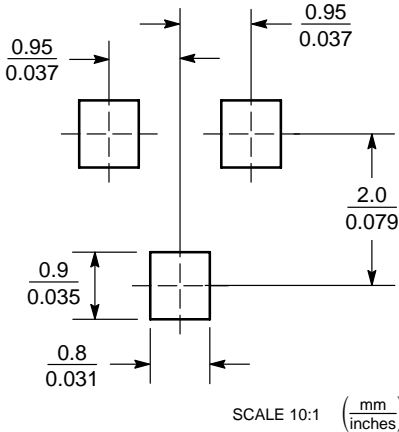

\*For additional information on our Pb-Free strategy and soldering details, please download the ON Semiconductor Soldering and Mounting Techniques Reference Manual, SOLDERRM/D.

ON Semiconductor and  are registered trademarks of Semiconductor Components Industries, LLC (SCILLC). SCILLC reserves the right to make changes without further notice to any products herein. SCILLC makes no warranty, representation or guarantee regarding the suitability of its products for any particular purpose, nor does SCILLC assume any liability arising out of the application or use of any product or circuit, and specifically disclaims any and all liability, including without limitation special, consequential or incidental damages. "Typical" parameters which may be provided in SCILLC data sheets and/or specifications can and do vary in different applications and actual performance may vary over time. All operating parameters, including "Typicals" must be validated for each customer application by customer's technical experts. SCILLC does not convey any license under its patent rights nor the rights of others. SCILLC products are not designed, intended, or authorized for use as components in systems intended for surgical implant into the body, or other applications intended to support or sustain life, or for any other application in which the failure of the SCILLC product could create a situation where personal injury or death may occur. Should Buyer purchase or use SCILLC products for any such unintended or unauthorized application, Buyer shall indemnify and hold SCILLC and its officers, employees, subsidiaries, affiliates, and distributors harmless against all claims, costs, damages, and expenses, and reasonable attorney fees arising out of, directly or indirectly, any claim of personal injury or death associated with such unintended or unauthorized use, even if such claim alleges that SCILLC was negligent regarding the design or manufacture of the part. SCILLC is an Equal Opportunity/Affirmative Action Employer. This literature is subject to all applicable copyright laws and is not for resale in any manner.

### PUBLICATION ORDERING INFORMATION

#### LITERATURE FULFILLMENT:

Literature Distribution Center for ON Semiconductor  
P.O. Box 5163, Denver, Colorado 80217 USA

Phone: 303-675-2175 or 800-344-3860 Toll Free USA/Canada

Fax: 303-675-2176 or 800-344-3867 Toll Free USA/Canada

Email: orderlit@onsemi.com

N. American Technical Support: 800-282-9855 Toll Free  
USA/Canada

Japan: ON Semiconductor, Japan Customer Focus Center

2-9-1 Kamimeguro, Meguro-ku, Tokyo, Japan 153-0051

Phone: 81-3-5773-3850

ON Semiconductor Website: <http://onsemi.com>

Order Literature: <http://www.onsemi.com/litorder>

For additional information, please contact your local Sales Representative.