

# Amplifier Transistors

## NPN Silicon

**BC237,A,B,C**  
**BC238B,C**  
**BC239C**

### MAXIMUM RATINGS

Rating	Symbol	BC237	BC238	BC239	Unit
Collector–Emitter Voltage	$V_{CEO}$	45	25	25	Vdc
Collector–Emitter Voltage	$V_{CES}$	50	30	30	Vdc
Emitter–Base Voltage	$V_{EBO}$	6.0	5.0	5.0	Vdc
Collector Current — Continuous	$I_C$	100			mAdc
Total Device Dissipation @ $T_A = 25^\circ\text{C}$ Derate above $25^\circ\text{C}$	$P_D$	350			mW
		2.8			mW/ $^\circ\text{C}$
Total Device Dissipation @ $T_C = 25^\circ\text{C}$ Derate above $25^\circ\text{C}$	$P_D$	1.0			Watts
		8.0			mW/ $^\circ\text{C}$
Operating and Storage Junction Temperature Range	$T_J, T_{stg}$	–55 to +150			$^\circ\text{C}$

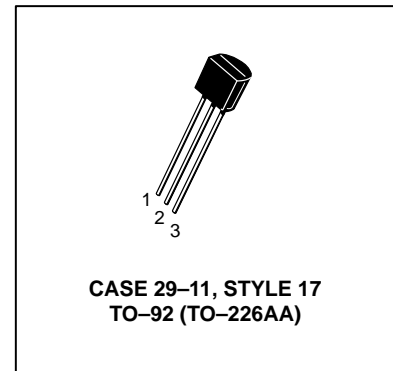

### THERMAL CHARACTERISTICS

Characteristic	Symbol	Max	Unit
Thermal Resistance, Junction to Ambient	$R_{\theta JA}$	357	$^\circ\text{C}/\text{W}$
Thermal Resistance, Junction to Case	$R_{\theta JC}$	125	$^\circ\text{C}/\text{W}$

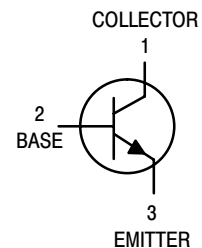

### ELECTRICAL CHARACTERISTICS ( $T_A = 25^\circ\text{C}$ unless otherwise noted)

Characteristic	Symbol	Min	Typ	Max	Unit
----------------	--------	-----	-----	-----	------

### OFF CHARACTERISTICS

Collector–Emitter Breakdown Voltage ( $I_C = 2.0\text{ mA}, I_B = 0$ )	BC237 BC238 BC239	$V_{(BR)CEO}$	45 25 25	— — —	— — —	V
Emitter–Base Breakdown Voltage ( $I_E = 100\ \mu\text{A}, I_C = 0$ )	BC237 BC238 BC239	$V_{(BR)EBO}$	6.0 5.0 5.0	— — —	— — —	V
Collector Cutoff Current ( $V_{CE} = 30\text{ V}, V_{BE} = 0$ )	BC238 BC239	$I_{CES}$	— —	0.2 0.2	15 15	nA
( $V_{CE} = 50\text{ V}, V_{BE} = 0$ )	BC237		—	0.2	15	
( $V_{CE} = 30\text{ V}, V_{BE} = 0$ ) $T_A = 125^\circ\text{C}$	BC238 BC239		— —	0.2 0.2	4.0 4.0	$\mu\text{A}$
( $V_{CE} = 50\text{ V}, V_{BE} = 0$ ) $T_A = 125^\circ\text{C}$	BC237	—	0.2	4.0		

## BC237,A,B,C BC238B,C BC239C

### ELECTRICAL CHARACTERISTICS ( $T_A = 25^\circ\text{C}$ unless otherwise noted) (Continued)

Characteristic	Symbol	Min	Typ	Max	Unit
<b>ON CHARACTERISTICS</b>					
DC Current Gain ( $I_C = 10\ \mu\text{A}$ , $V_{CE} = 5.0\ \text{V}$ )	BC237A	—	90	—	—
	BC237B/238B	—	150	—	—
	BC237C/238C/239C	—	270	—	—
( $I_C = 2.0\ \text{mA}$ , $V_{CE} = 5.0\ \text{V}$ )	BC237	120	—	800	—
	BC237A	120	170	220	—
	BC237B/238B	200	290	460	—
	BC237C/238C/239C	380	500	800	—
( $I_C = 100\ \text{mA}$ , $V_{CE} = 5.0\ \text{V}$ )	BC237A	—	120	—	—
	BC237B/238B	—	180	—	—
	BC237C/238C/239C	—	300	—	—
Collector–Emitter On Voltage ( $I_C = 10\ \text{mA}$ , $I_B = 0.5\ \text{mA}$ ) ( $I_C = 100\ \text{mA}$ , $I_B = 5.0\ \text{mA}$ )	BC237/BC238/BC239	—	0.07	0.2	V
	BC237/BC239	—	0.2	0.6	V
	BC238	—	—	0.8	V
Base–Emitter Saturation Voltage ( $I_C = 10\ \text{mA}$ , $I_B = 0.5\ \text{mA}$ ) ( $I_C = 100\ \text{mA}$ , $I_B = 5.0\ \text{mA}$ )		—	0.6	0.83	V
		—	—	1.05	V
Base–Emitter On Voltage ( $I_C = 100\ \mu\text{A}$ , $V_{CE} = 5.0\ \text{V}$ ) ( $I_C = 2.0\ \text{mA}$ , $V_{CE} = 5.0\ \text{V}$ ) ( $I_C = 100\ \text{mA}$ , $V_{CE} = 5.0\ \text{V}$ )		—	0.5	—	V
		0.55	0.62	0.7	V
		—	0.83	—	V
<b>DYNAMIC CHARACTERISTICS</b>					
Current–Gain — Bandwidth Product ( $I_C = 0.5\ \text{mA}$ , $V_{CE} = 3.0\ \text{V}$ , $f = 100\ \text{MHz}$ )	BC237	—	100	—	MHz
	BC238	—	120	—	MHz
	BC239	—	140	—	MHz
( $I_C = 10\ \text{mA}$ , $V_{CE} = 5.0\ \text{V}$ , $f = 100\ \text{MHz}$ )	BC237	150	200	—	MHz
	BC238	150	240	—	MHz
	BC239	150	280	—	MHz
Collector–Base Capacitance ( $V_{CB} = 10\ \text{V}$ , $I_C = 0$ , $f = 1.0\ \text{MHz}$ )		—	—	4.5	pF
Emitter–Base Capacitance ( $V_{EB} = 0.5\ \text{V}$ , $I_C = 0$ , $f = 1.0\ \text{MHz}$ )		—	8.0	—	pF
Noise Figure ( $I_C = 0.2\ \text{mA}$ , $V_{CE} = 5.0\ \text{V}$ , $R_S = 2.0\ \text{k}\Omega$ , $f = 1.0\ \text{kHz}$ )	BC239	—	2.0	4.0	dB
		—	—	—	dB
	BC237	—	2.0	10	dB
	BC238	—	2.0	10	dB
( $I_C = 0.2\ \text{mA}$ , $V_{CE} = 5.0\ \text{V}$ , $R_S = 2.0\ \text{k}\Omega$ , $f = 1.0\ \text{kHz}$ , $\Delta f = 200\ \text{Hz}$ )	BC239	—	2.0	4.0	dB
	BC237	—	2.0	10	dB
	BC238	—	2.0	10	dB
	BC239	—	2.0	4.0	dB

BC237,A,B,C BC238B,C BC239C

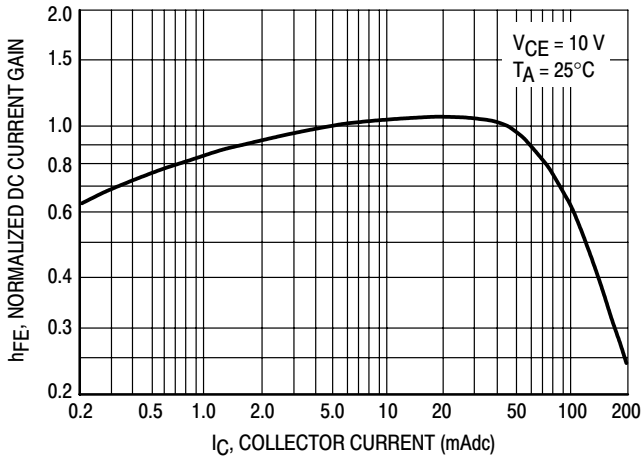

Figure 1. Normalized DC Current Gain

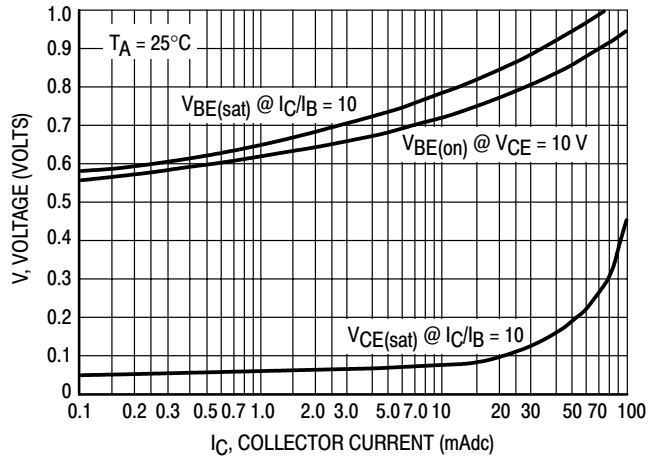

Figure 2. "Saturation" and "On" Voltages

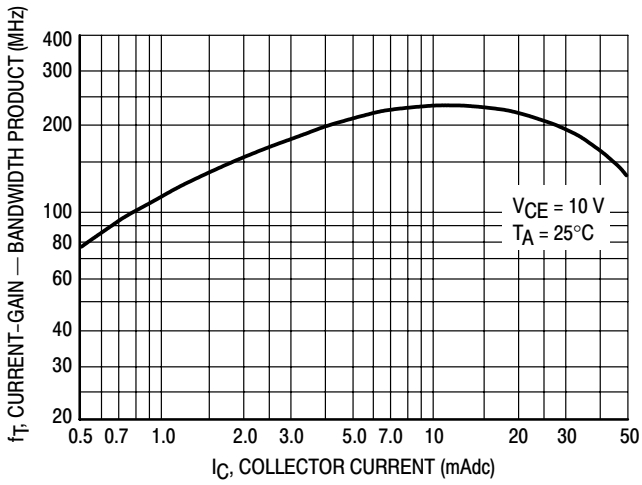

Figure 3. Current-Gain — Bandwidth Product

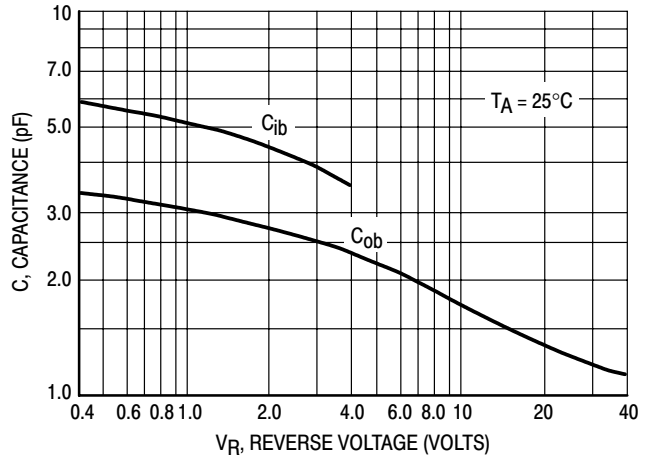

Figure 4. Capacitances

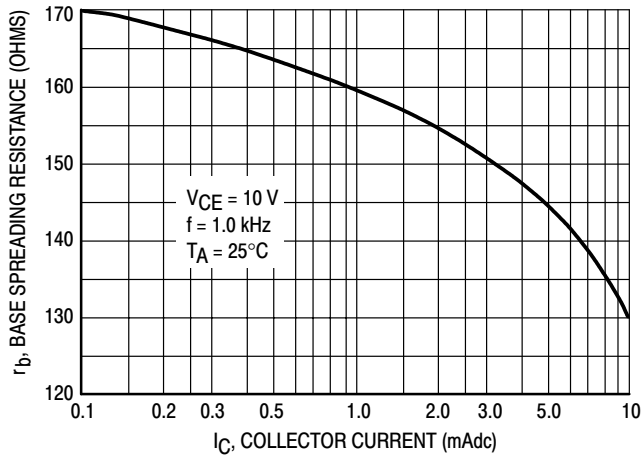
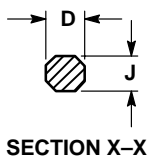
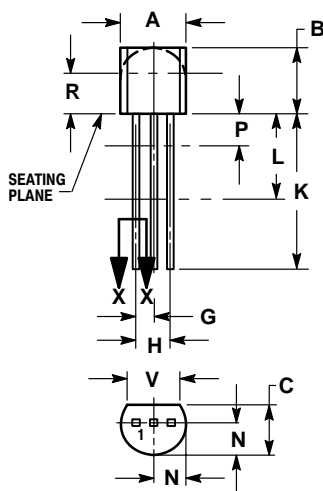

Figure 5. Base Spreading Resistance

# BC237,A,B,C BC238B,C BC239C

## PACKAGE DIMENSIONS

### TO-92 (TO-226) CASE 29-11 ISSUE AL



STYLE 17:  
PIN 1. COLLECTOR  
2. BASE  
3. EMITTER

#### NOTES:

1. DIMENSIONING AND TOLERANCING PER ANSI Y14.5M, 1982.
2. CONTROLLING DIMENSION: INCH.
3. CONTOUR OF PACKAGE BEYOND DIMENSION R IS UNCONTROLLED.
4. LEAD DIMENSION IS UNCONTROLLED IN P AND BEYOND DIMENSION K MINIMUM.

DIM	INCHES		MILLIMETERS	
	MIN	MAX	MIN	MAX
A	0.175	0.205	4.45	5.20
B	0.170	0.210	4.32	5.33
C	0.125	0.165	3.18	4.19
D	0.016	0.021	0.407	0.533
G	0.045	0.055	1.15	1.39
H	0.095	0.105	2.42	2.66
J	0.015	0.020	0.39	0.50
K	0.500	---	12.70	---
L	0.250	---	6.35	---
N	0.080	0.105	2.04	2.66
P	---	0.100	---	2.54
R	0.115	---	2.93	---
V	0.135	---	3.43	---

**ON Semiconductor** and  are trademarks of Semiconductor Components Industries, LLC (SCILLC). SCILLC reserves the right to make changes without further notice to any products herein. SCILLC makes no warranty, representation or guarantee regarding the suitability of its products for any particular purpose, nor does SCILLC assume any liability arising out of the application or use of any product or circuit, and specifically disclaims any and all liability, including without limitation special, consequential or incidental damages. "Typical" parameters which may be provided in SCILLC data sheets and/or specifications can and do vary in different applications and actual performance may vary over time. All operating parameters, including "Typicals" must be validated for each customer application by customer's technical experts. SCILLC does not convey any license under its patent rights nor the rights of others. SCILLC products are not designed, intended, or authorized for use as components in systems intended for surgical implant into the body, or other applications intended to support or sustain life, or for any other application in which the failure of the SCILLC product could create a situation where personal injury or death may occur. Should Buyer purchase or use SCILLC products for any such unintended or unauthorized application, Buyer shall indemnify and hold SCILLC and its officers, employees, subsidiaries, affiliates, and distributors harmless against all claims, costs, damages, and expenses, and reasonable attorney fees arising out of, directly or indirectly, any claim of personal injury or death associated with such unintended or unauthorized use, even if such claim alleges that SCILLC was negligent regarding the design or manufacture of the part. SCILLC is an Equal Opportunity/Affirmative Action Employer.

#### PUBLICATION ORDERING INFORMATION

##### Literature Fulfillment:

Literature Distribution Center for ON Semiconductor  
P.O. Box 5163, Denver, Colorado 80217 USA  
**Phone:** 303-675-2175 or 800-344-3860 Toll Free USA/Canada  
**Fax:** 303-675-2176 or 800-344-3867 Toll Free USA/Canada  
**Email:** ONlit@hibbertco.com

**N. American Technical Support:** 800-282-9855 Toll Free USA/Canada

**JAPAN:** ON Semiconductor, Japan Customer Focus Center  
4-32-1 Nishi-Gotanda, Shinagawa-ku, Tokyo, Japan 141-0031  
**Phone:** 81-3-5740-2700  
**Email:** r14525@onsemi.com

**ON Semiconductor Website:** <http://onsemi.com>

For additional information, please contact your local Sales Representative.