

# 74LCX14

## Low Voltage Hex Inverter with 5V Tolerant Schmitt Trigger Inputs

### General Description

The LCX14 contains six inverter gates each with a Schmitt trigger input. They are capable of transforming slowly changing input signals into sharply defined, jitter-free output signals. In addition, they have a greater noise margin than conventional inverters.

The LCX14 has hysteresis between the positive-going and negative-going input thresholds (typically 1.0V) which is determined internally by transistor ratios and is essentially insensitive to temperature and supply voltage variations.

The inputs tolerate voltages up to 7V allowing the interface of 5V, 3V and 2.5V systems.

The 74LCX14 is fabricated with advanced CMOS technology to achieve high speed operation while maintaining CMOS low power dissipation.

### Features

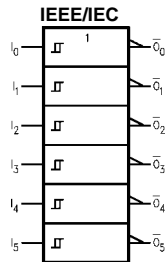
- 5V tolerant inputs
- 2.3V–3.6V  $V_{CC}$  specifications provided
- 6.5 ns  $t_{PD}$  max ( $V_{CC} = 3.3V$ ), 10  $\mu A$   $I_{CC}$  max
- Power down high impedance inputs and outputs
- $\pm 24$  mA output drive ( $V_{CC} = 3.0V$ )
- Implements patented noise/EMI reduction circuitry
- Latch-up performance exceeds 500 mA
- ESD performance:
  - Machine model > 2000V
  - Human model > 200V

### Ordering Code:

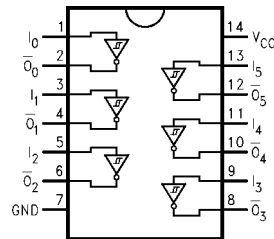
Order Number	Package Number	Package Description
74LCX14M	M14A	14-Lead Small Outline Integrated Circuit (SOIC), JEDEC MS-120, 0.150" Narrow
74LCX14SJ	M14D	14-Lead Small Outline Package (SOP), EIAJ TYPE II, 5.3mm Wide
74LCX14MTC	MTC14	14-Lead Thin Shrink Small Outline Package (TSSOP), JEDEC MO-153, 4.4mm Wide

Devices also available in Tape and Reel. Specify by appending the suffix letter "X" to the ordering code.

### Logic Symbol



### Connection Diagram



### Pin Descriptions

Pin Names	Description
$I_n$	Inputs
$\bar{O}_n$	Outputs

### Truth Table

Input	Output
A	$\bar{O}$
L	H
H	L

Absolute Maximum Ratings (Note 1)					
Symbol	Parameter	Value	Conditions	Units	
$V_{CC}$	Supply Voltage	-0.5 to +7.0		V	
$V_I$	DC Input Voltage	-0.5 to +7.0		V	
$V_O$	DC Output Voltage	-0.5 to $V_{CC} + 0.5$	Output in HIGH or LOW State (Note 2)	V	
$I_{IK}$	DC Input Diode Current	-50	$V_I < \text{GND}$	mA	
$I_{OK}$	DC Output Diode Current	-50	$V_O < \text{GND}$	mA	
		+50	$V_O > V_{CC}$	mA	
$I_O$	DC Output Source/Sink Current	$\pm 50$		mA	
$I_{CC}$	DC Supply Current per Supply Pin	$\pm 100$		mA	
$I_{GND}$	DC Ground Current per Ground Pin	$\pm 100$		mA	
$T_{STG}$	Storage Temperature	-65 to +150		°C	

Recommended Operating Conditions (Note 3)					
Symbol	Parameter	Min	Max	Units	
$V_{CC}$	Supply Voltage	Operating	2.0	3.6	V
		Data Retention	1.5	3.6	
$V_I$	Input Voltage	0	5.5	V	
$V_O$	Output Voltage	0	$V_{CC}$	V	
$I_{OH}/I_{OL}$	Output Current	$V_{CC} = 3.0V - 3.6V$		$\pm 24$	mA
		$V_{CC} = 2.7V - 3.0V$		$\pm 12$	
		$V_{CC} = 2.3V - 2.7V$		$\pm 8$	

**Note 1:** The Absolute Maximum Ratings are those values beyond which the safety of the device cannot be guaranteed. The device should not be operated at these limits. The parametric values defined in the Electrical Characteristics tables are not guaranteed at the Absolute Maximum Ratings. The "Recommended Operating Conditions" table will define the conditions for actual device operation.

**Note 2:**  $I_O$  Absolute Maximum Rating must be observed.

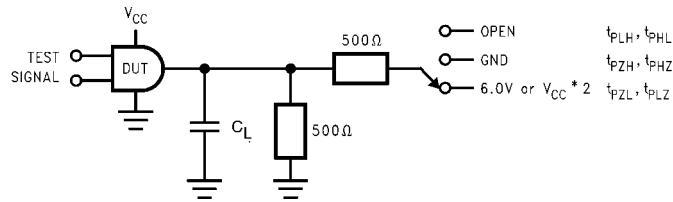
**Note 3:** Unused inputs must be held HIGH or LOW. They may not float.

### DC Electrical Characteristics

Symbol	Parameter	Conditions	$V_{CC}$ (V)	$T_A = -40^\circ\text{C to } +85^\circ\text{C}$		Units
				Min	Max	
$V_{I+}$	Positive Input Threshold		2.5	0.9	1.7	V
			3.0	1.2	2.2	
$V_{I-}$	Negative Input Threshold		2.5	0.4	1.1	V
			3.0	0.6	1.5	
$V_H$	Hysteresis		2.5	0.3	1.0	V
			3.0	0.4	1.2	
$V_{OH}$	HIGH Level Output Voltage	$I_{OH} = -100\mu\text{A}$	2.3 - 3.6	$V_{CC} - 0.2$		V
		$I_{OH} = -8\text{ mA}$	2.3	1.8		
		$I_{OH} = -12\text{ mA}$	2.7	2.2		
		$I_{OH} = -18\text{ mA}$	3.0	2.4		
		$I_{OH} = -24\text{ mA}$	3.0	2.2		
$V_{OL}$	LOW Level Output Voltage	$I_{OL} = 100\mu\text{A}$	2.3 - 3.6	0.2		V
		$I_{OL} = 8\text{ mA}$	2.3	0.6		
		$I_{OL} = 12\text{ mA}$	2.7	0.4		
		$I_{OL} = 16\text{ mA}$	3.0	0.4		
		$I_{OL} = 24\text{ mA}$	3.0	0.55		
$I_I$	Input Leakage Current	$0 \leq V_I \leq 5.5V$	2.3 - 3.6	$\pm 5.0$		$\mu\text{A}$
$I_{OFF}$	Power-Off Leakage Current	$V_I$ or $V_O = 5.5V$	0	10		$\mu\text{A}$
$I_{CC}$	Quiescent Supply Current	$V_I = V_{CC}$ or GND	2.3 - 3.6	10		$\mu\text{A}$
		$3.6V \leq V_I \leq 5.5V$	2.3 - 3.6	$\pm 10$		
$\Delta I_{CC}$	Increase in $I_{CC}$ per Input	$V_{IH} = V_{CC} - 0.6V$	2.3 - 3.6	500		$\mu\text{A}$

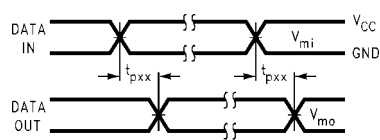
AC Electrical Characteristics								
Symbol	Parameter	$T_A = -40^\circ\text{C to } +85^\circ\text{C}, R_L = 500 \Omega$						Units
		$V_{CC} = 3.3V \pm 0.3V$		$V_{CC} = 2.7V$		$V_{CC} = 2.5V \pm 0.2V$		
		$C_L = 50 \text{ pF}$		$C_L = 50 \text{ pF}$		$C_L = 30 \text{ pF}$		
		Min	Max	Min	Max	Min	Max	
$t_{PHL}$	Propagation Delay Time	1.5	6.5	1.5	7.5	1.5	7.8	ns
$t_{PLH}$		1.5	6.5	1.5	7.5	1.5	7.8	
$t_{OSHL}$	Output to Output Skew (Note 4)		1.0					ns
$t_{OSLH}$			1.0					
<p><b>Note 4:</b> Skew is defined as the absolute value of the difference between the actual propagation delay for any two separate outputs of the same device. The specification applies to any outputs switching in the same direction, either HIGH-to-LOW (<math>t_{OSHL}</math>) or LOW-to-HIGH (<math>t_{OSLH}</math>).</p>								
Dynamic Switching Characteristics								
Symbol	Parameter	Conditions	$V_{CC}$ (V)	$T_A = 25^\circ\text{C}$	Units			
				Typical				
$V_{OLP}$	Quiet Output Dynamic Peak $V_{OL}$	$C_L = 50 \text{ pF}, V_{IH} = 3.3V, V_{IL} = 0V$	3.3	0.8	V			
		$C_L = 30 \text{ pF}, V_{IH} = 2.5V, V_{IL} = 0V$	2.5	0.6				
$V_{OLV}$	Quiet Output Dynamic Valley $V_{OL}$	$C_L = 50 \text{ pF}, V_{IH} = 3.3V, V_{IL} = 0V$	3.3	-0.8	V			
		$C_L = 30 \text{ pF}, V_{IH} = 2.5V, V_{IL} = 0V$	2.5	-0.6				
Capacitance								
Symbol	Parameter	Conditions	Typical	Units				
$C_{IN}$	Input Capacitance	$V_{CC} = \text{Open}, V_I = 0V \text{ or } V_{CC}$	7	pF				
$C_{OUT}$	Output Capacitance	$V_{CC} = 3.3V, V_I = 0V \text{ or } V_{CC}$	8	pF				
$C_{PD}$	Power Dissipation Capacitance	$V_{CC} = 3.3V, V_I = 0V \text{ or } V_{CC}, f = 10 \text{ MHz}$	25	pF				

**AC Loading and Waveforms** Generic for LCX Family

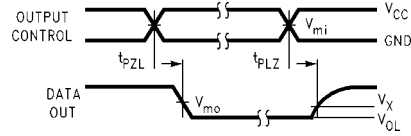


**FIGURE 1. AC Test Circuit**  
 ( $C_L$  includes probe and jig capacitance)

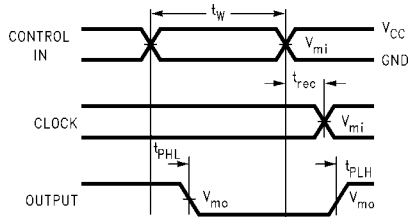
Test	Switch
$t_{PLH}, t_{PHL}$	Open
$t_{PZL}, t_{PLZ}$	6V at $V_{CC} = 3.3 \pm 0.3V$ $V_{CC} * 2$ at $V_{CC} = 2.5 \pm 0.2V$
$t_{PZH}, t_{PHZ}$	GND



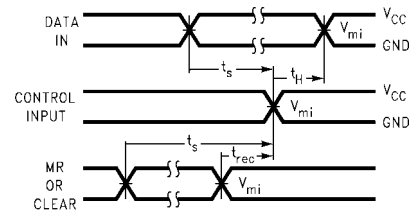
**Waveform for Inverting and Non-Inverting Functions**



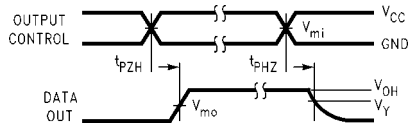
**3-STATE Output Low Enable and Disable Times for Logic**



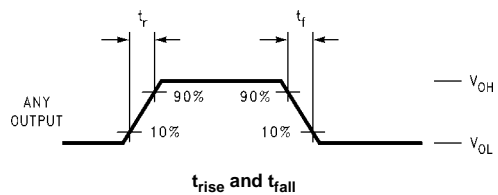
**Propagation Delay, Pulse Width and  $t_{rec}$  Waveforms**



**Setup Time, Hold Time and Recovery Time for Logic**



**3-STATE Output High Enable and Disable Times for Logic**

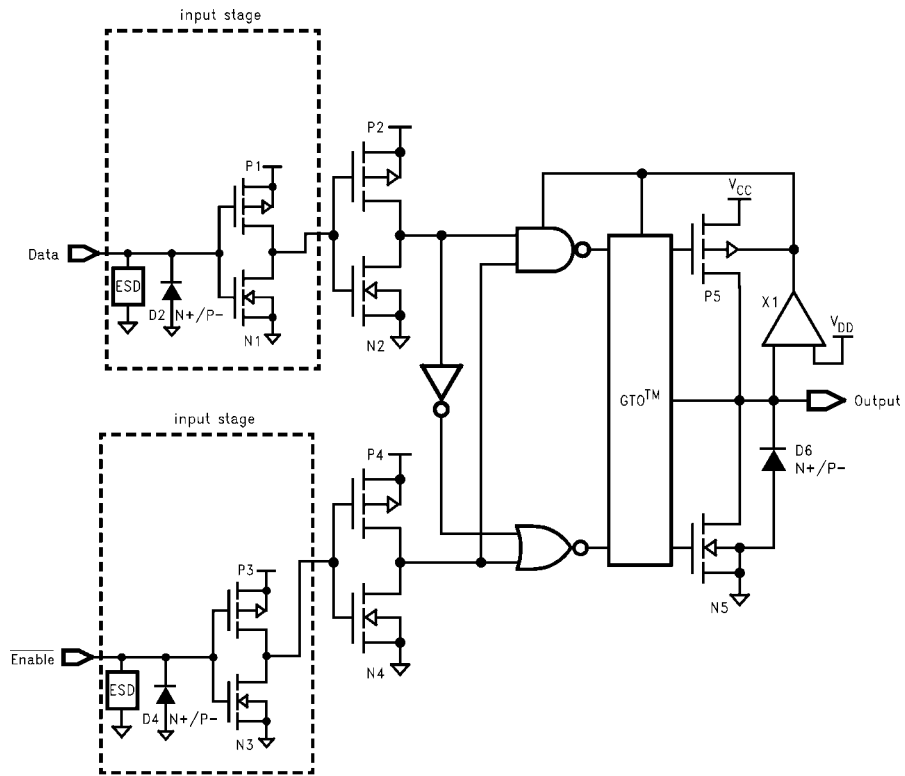


**FIGURE 2. Waveforms**

(Input Pulse Characteristics;  $f=1MHz, t_r=t_f=3ns$ )

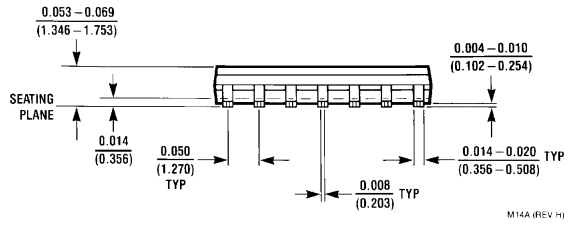
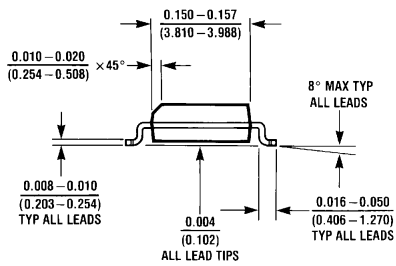
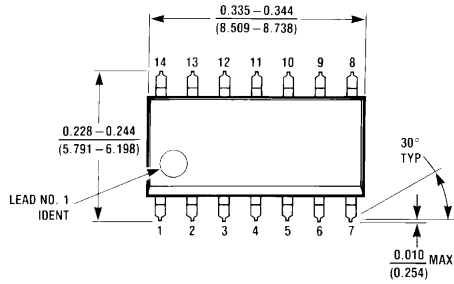
Symbol	$V_{CC}$		
	$3.3V \pm 0.3V$	2.7V	$2.5V \pm 0.2V$
$V_{mi}$	1.5V	1.5V	$V_{CC}/2$
$V_{mo}$	1.5V	1.5V	$V_{CC}/2$
$V_x$	$V_{OL} + 0.3V$	$V_{OL} + 0.3V$	$V_{OL} + 0.15V$
$V_y$	$V_{OH} - 0.3V$	$V_{OH} - 0.3V$	$V_{OH} - 0.15V$

**Schematic Diagram** Generic for LCX Family

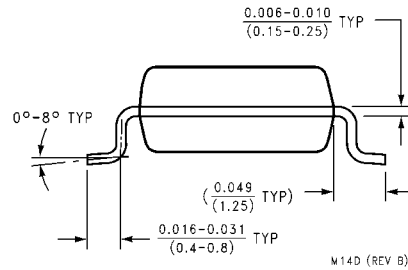
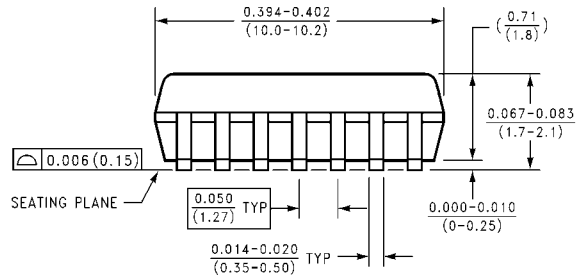
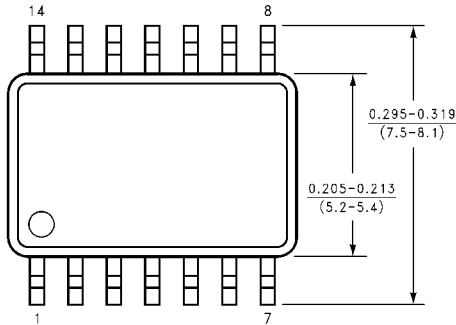


74LCX14

**Physical Dimensions** inches (millimeters) unless otherwise noted

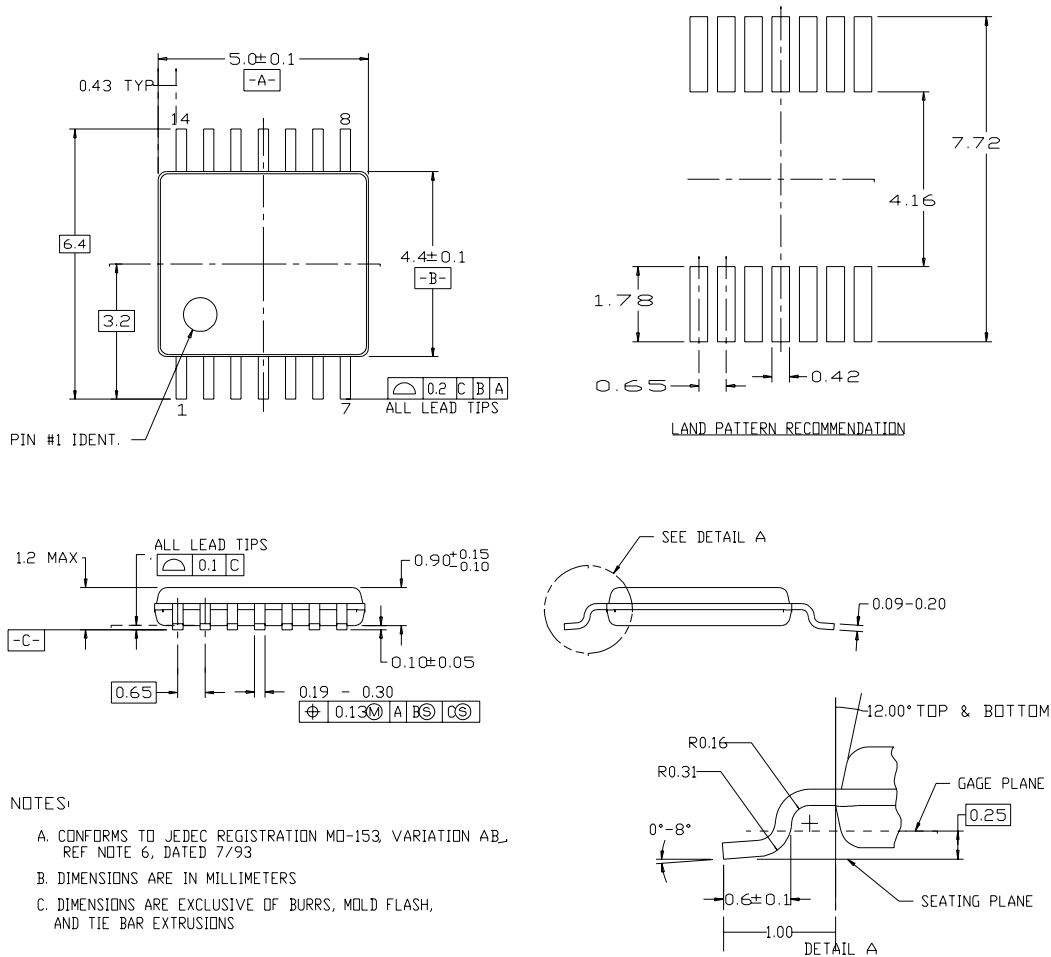


**14-Lead Small Outline Integrated Circuit (SOIC), JEDEC MS-120, 0.150" Narrow Package Number M14A**



**14-Lead Small Outline Package (SOP), EIAJ TYPE II, 5.3mm Wide Package Number M14D**

**Physical Dimensions** inches (millimeters) unless otherwise noted (Continued)



NOTES:

- A. CONFORMS TO JEDEC REGISTRATION MO-153, VARIATION AB, REF NOTE 6, DATED 7/93
- B. DIMENSIONS ARE IN MILLIMETERS
- C. DIMENSIONS ARE EXCLUSIVE OF BURRS, MOLD FLASH, AND TIE BAR EXTRUSIONS

**14-Lead Thin Shrink Small Outline Package (TSSOP), JEDEC MO-153, 4.4mm Wide  
Package Number MTC14**

**LIFE SUPPORT POLICY**

FAIRCHILD'S PRODUCTS ARE NOT AUTHORIZED FOR USE AS CRITICAL COMPONENTS IN LIFE SUPPORT DEVICES OR SYSTEMS WITHOUT THE EXPRESS WRITTEN APPROVAL OF THE PRESIDENT OF FAIRCHILD SEMICONDUCTOR CORPORATION. As used herein:

1. Life support devices or systems are devices or systems which, (a) are intended for surgical implant into the body, or (b) support or sustain life, and (c) whose failure to perform when properly used in accordance with instructions for use provided in the labeling, can be reasonably expected to result in a significant injury to the user.
2. A critical component in any component of a life support device or system whose failure to perform can be reasonably expected to cause the failure of the life support device or system, or to affect its safety or effectiveness.

[www.fairchildsemi.com](http://www.fairchildsemi.com)