



60EPU04
60APU04

Ultrafast Soft Recovery Diode

Features

- Ultrafast Recovery
- 175°C Operating Junction Temperature

Benefits

- Reduced RFI and EMI
- Higher Frequency Operation
- Reduced Snubbing
- Reduced Parts Count

| |
|------------------------------|
| $t_{rr} = 50\text{ns (typ)}$ |
| $I_{F(AV)} = 60\text{Amp}$ |
| $V_R = 400\text{V}$ |

Description/ Applications



These diodes are optimized to reduce losses and EMI/ RFI in high frequency power conditioning systems. The softness of the recovery eliminates the need for a snubber in most applications. These devices are ideally suited for HF welding, power converters and other applications where switching losses are not significant portion of the total losses.

Absolute Maximum Ratings

| Parameters | Max | Units |
|---|-------------|------------------|
| V_R Cathode to Anode Voltage | 400 | V |
| $I_{F(AV)}$ Continuous Forward Current, $T_C = 127^\circ\text{C}$ | 60 | A |
| I_{FSM} Single Pulse Forward Current, $T_C = 25^\circ\text{C}$ | 600 | |
| I_{FRM} ① Maximum Repetitive Forward Current | 120 | |
| T_J, T_{STG} Operating Junction and Storage Temperatures | - 55 to 175 | $^\circ\text{C}$ |

① Square Wave, 20kHz

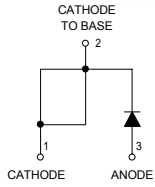
Case Styles

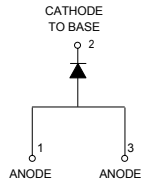
| | |
|---|--|
| <p>60EPU04</p>   <p>CATHODE TO BASE</p> <p>CATHODE ANODE</p> <p>TO-247AC (Modified)</p> | <p>60APU04</p>   <p>CATHODE TO BASE</p> <p>ANODE ANODE</p> <p>TO-247AC</p> |
|---|--|

Electrical Characteristics @ T_J = 25°C (unless otherwise specified)

| Parameters | Min | Typ | Max | Units | Test Conditions |
|--|-----|------|------|-------|---|
| V _{BR} , V _r Breakdown Voltage, Blocking Voltage | 400 | - | - | V | I _R = 100μA |
| V _F Forward Voltage | - | 1.05 | 1.25 | V | I _F = 60A |
| | - | 0.87 | 1.03 | V | I _F = 60A, T _J = 175°C |
| | - | 0.93 | 1.10 | V | I _F = 60A, T _J = 125°C |
| I _R Reverse Leakage Current | - | - | 50 | μA | V _R = V _R Rated |
| | - | - | 2 | mA | T _J = 150°C, V _R = V _R Rated |
| C _T Junction Capacitance | - | 50 | - | pF | V _R = 400V |
| L _S Series Inductance | - | 3.5 | - | nH | Measured lead to lead 5mm from package body |

Dynamic Recovery Characteristics @ T_J = 25°C (unless otherwise specified)

| Parameters | Min | Typ | Max | Units | Test Conditions | |
|---|-----|------|-----|-------|--|--|
| t _{rr} Reverse Recovery Time | - | 50 | 60 | ns | I _F = 1A, di _F /dt = 200A/μs, V _R = 30V | |
| | - | 85 | - | | T _J = 25°C | I _F = 60A V _R = 200V di _F /dt = 200A/μs |
| | - | 145 | - | | T _J = 125°C | |
| I _{RRM} Peak Recovery Current | - | 8.8 | - | A | T _J = 25°C | |
| | - | 15.4 | - | | T _J = 125°C | |
| Q _{rr} Reverse Recovery Charge | - | 375 | - | nC | T _J = 25°C | |
| | - | 1120 | - | | T _J = 125°C | |

Thermal - Mechanical Characteristics

| Parameters | Min | Typ | Max | Units |
|--|-----|-----|------|--------|
| R _{thJC} Thermal Resistance, Junction to Case | | | 0.70 | K/W |
| R _{thCS} ② Thermal Resistance, Case to Heatsink | | 0.2 | | |
| Wt Weight | | 5.5 | | g |
| | | 0.2 | | (oz) |
| T Mounting Torque | 1.2 | | 2.4 | N * m |
| | 10 | | 20 | lbf.in |

② Mounting Surface, Flat, Smooth and Greased

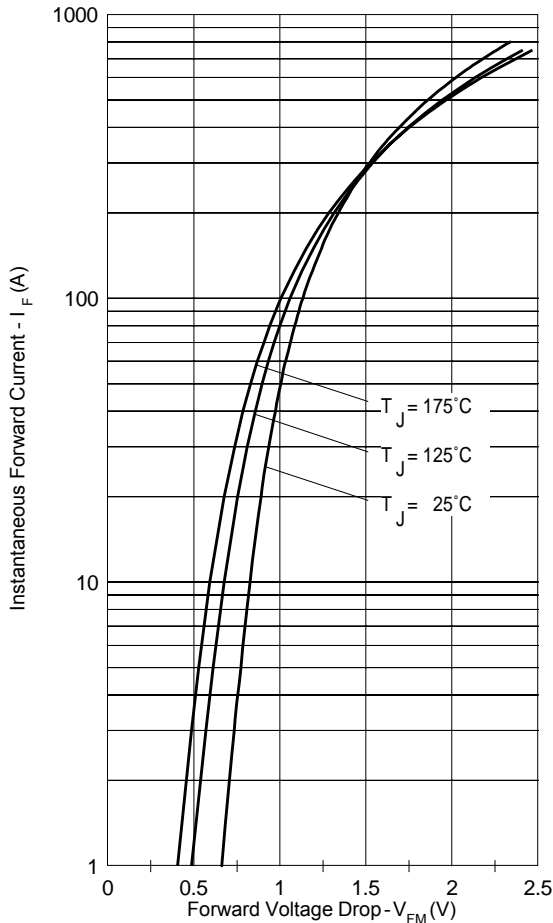

Fig. 1 - Typical Forward Voltage Drop Characteristics

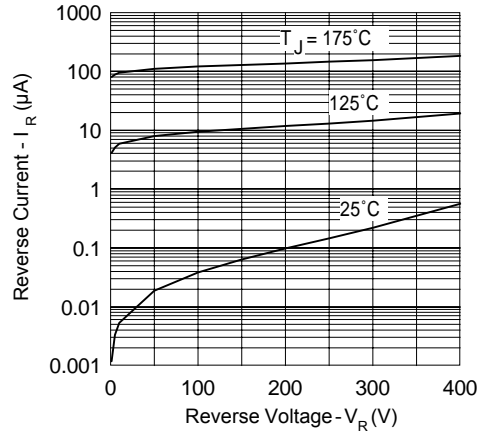

Fig. 2 - Typical Values Of Reverse Current Vs. Reverse Voltage

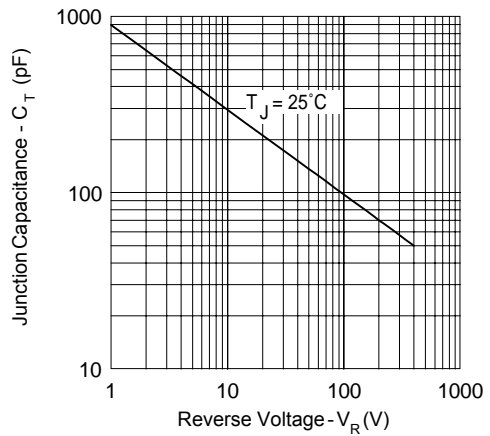

Fig. 3 - Typical Junction Capacitance Vs. Reverse Voltage

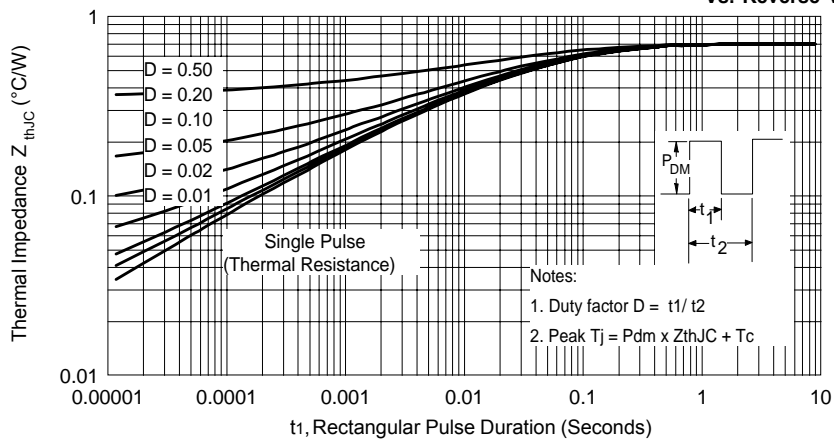

Fig. 4 - Max. Thermal Impedance Z_{thJC} Characteristics

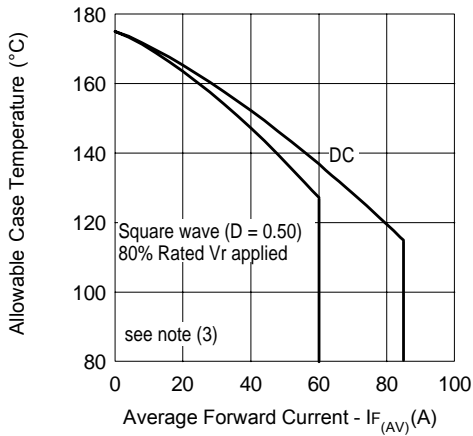

Fig. 5 - Max. Allowable Case Temperature Vs. Average Forward Current

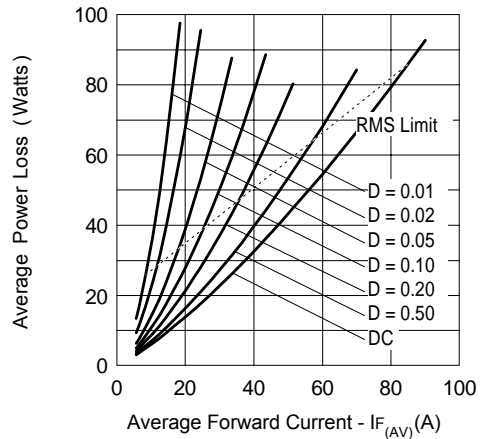

Fig. 6 - Forward Power Loss Characteristics

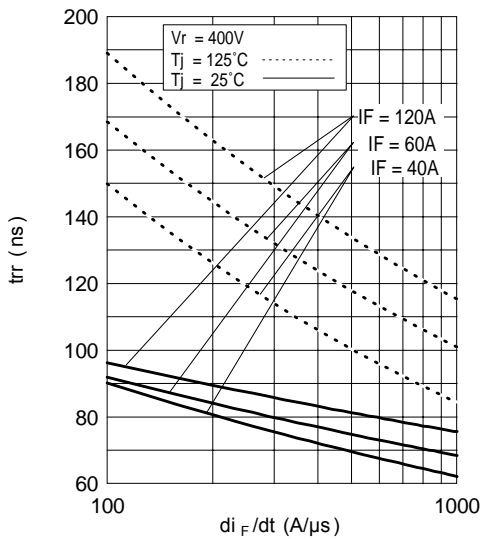

Fig. 7 - Typical Reverse Recovery time vs. di_F/dt

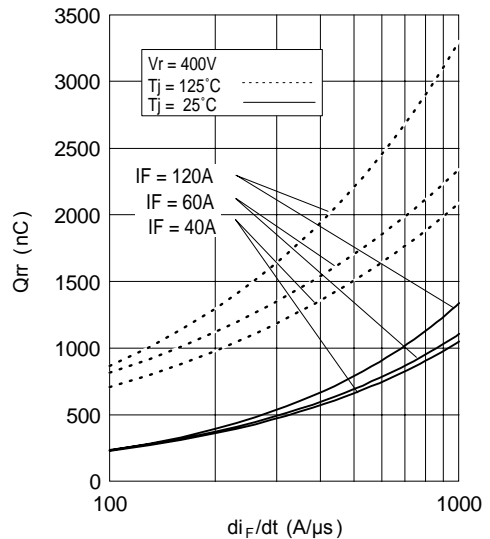

Fig. 8 - Typical Stored Charge vs. di_F/dt

(3) Formula used: $T_c = T_j - (P_d + P_{d_{REV}}) \times R_{thJC}$;
 $P_d = \text{Forward Power Loss} = I_{F(AV)} \times V_{FM} @ (I_{F(AV)} / D)$ (see Fig. 6);
 $P_{d_{REV}} = \text{Inverse Power Loss} = V_{R1} \times I_R (1 - D); I_R @ V_{R1} = 80\% \text{ rated } V_R$

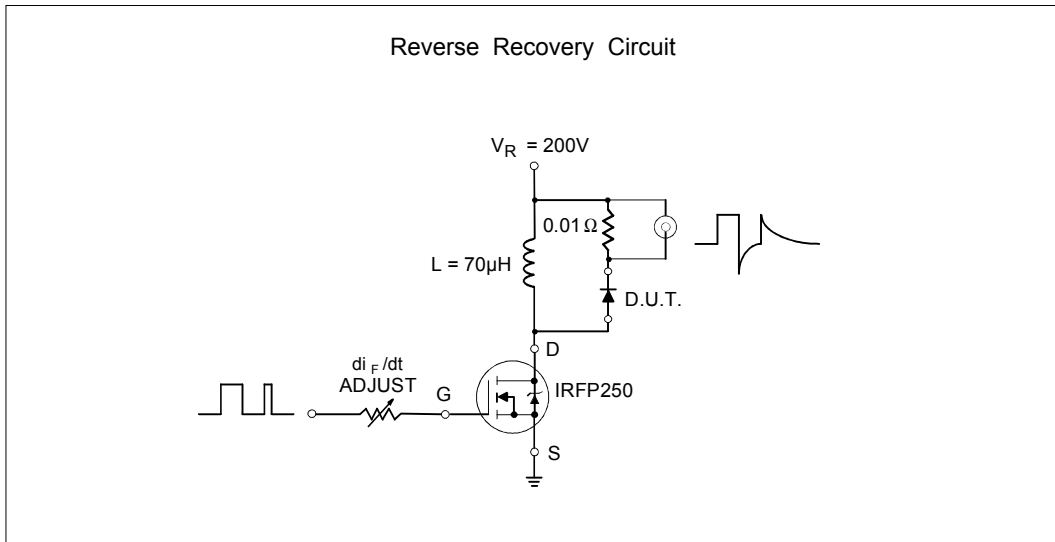

Fig. 9- Reverse Recovery Parameter Test Circuit

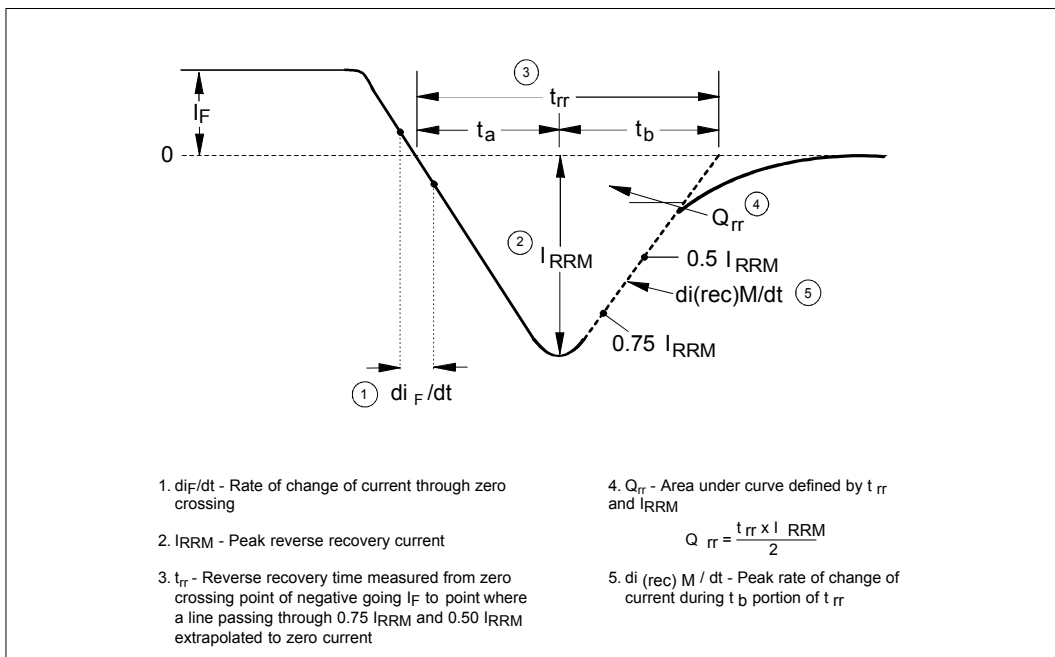
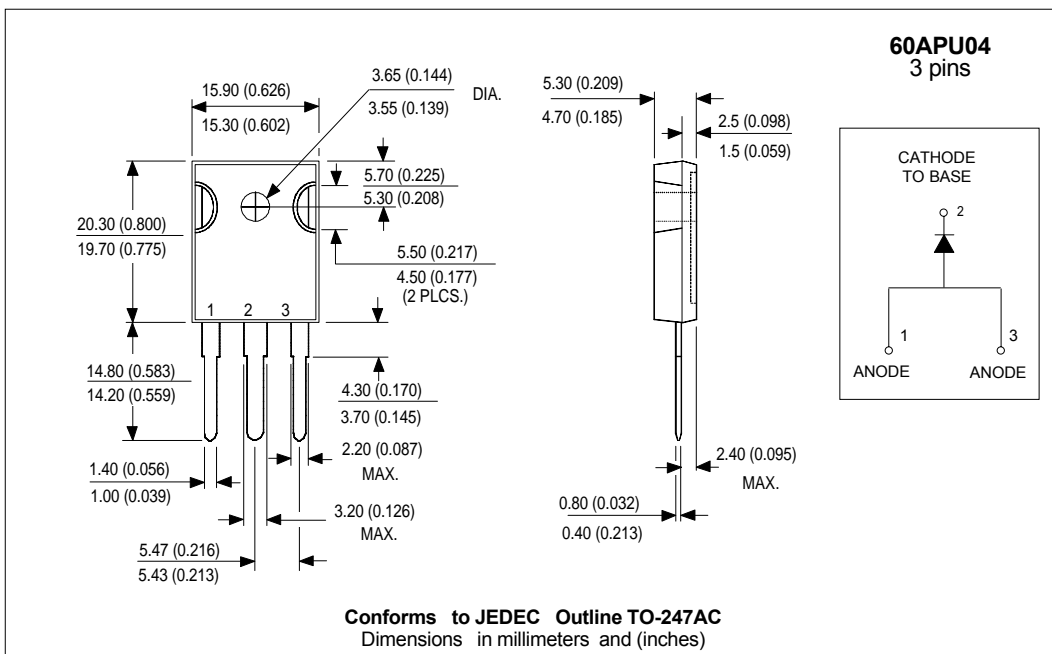
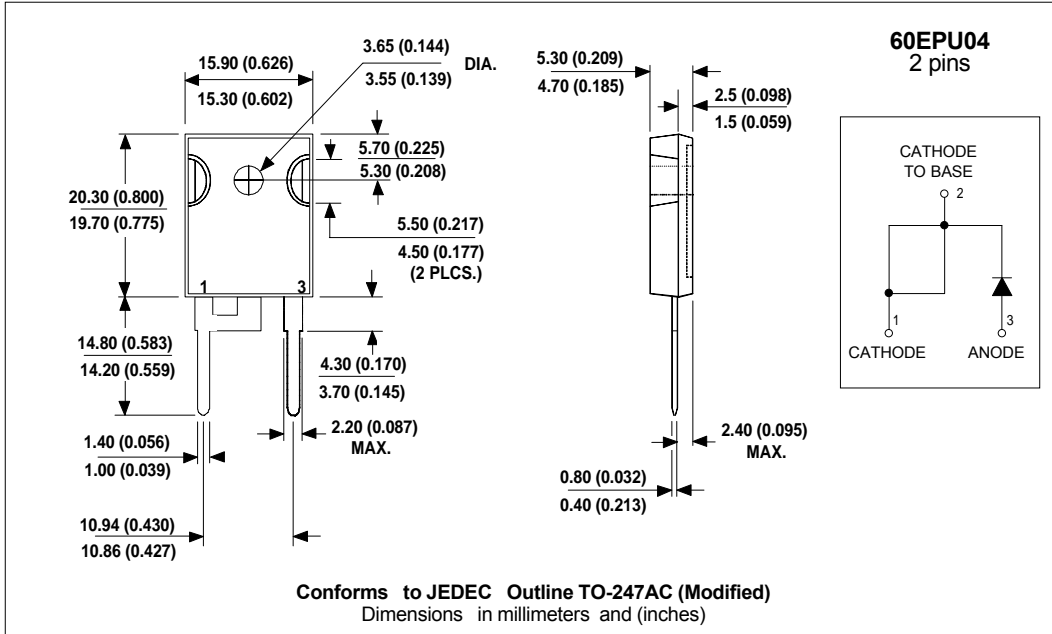
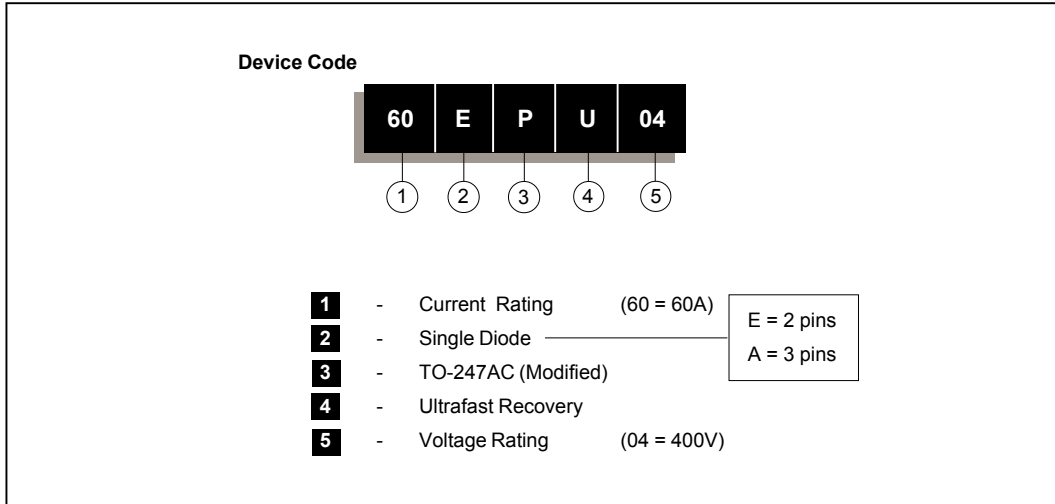

Fig. 10 - Reverse Recovery Waveform and Definitions

Outline Table



Ordering Information Table



Data and specifications subject to change without notice.
 This product has been designed and qualified for Industrial Level.
 Qualification Standards can be found on IR's Web site.