

**2SC4834**  
(TP8V40FS)

**8A NPN**

### OUTLINE DIMENSIONS

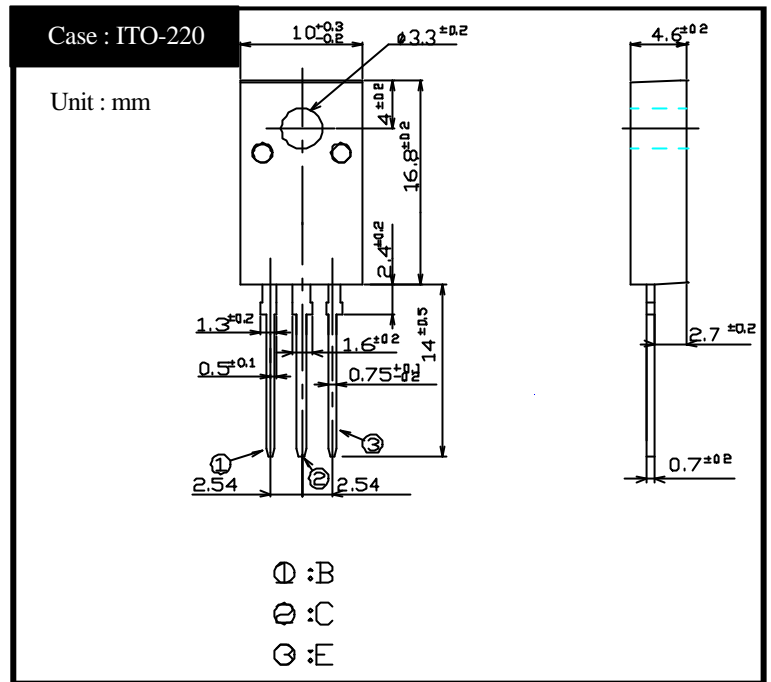

### RATINGS

#### Absolute Maximum Ratings

Item	Symbol	Conditions	Ratings	Unit
Storage Temperature	T <sub>stg</sub>		-55 ~ 150	
Junction Temperature	T <sub>j</sub>		150	
Collector to Base Voltage	V <sub>CB0</sub>		500	V
Collector to Emitter Voltage	V <sub>CE0</sub>		400	V
Emitter to Base Voltage	V <sub>EBO</sub>		7	V
Collector Current DC	I <sub>C</sub>		8	A
Collector Current Peak	I <sub>CP</sub>		16	
Base Current DC	I <sub>B</sub>		3	A
Base Current Peak	I <sub>BP</sub>		6	
Total Transistor Dissipation	P <sub>T</sub>	T <sub>C</sub> = 25	45	W
Dielectric Strength	V <sub>dis</sub>	Terminals to case, AC 1 minute	2	kV
Mounting Torque	TOR	(Recommended torque : 0.3N·m)	0.5	N·m

#### Electrical Characteristics (T<sub>C</sub>=25 )

Item	Symbol	Conditions	Ratings	Unit
Collector to Emitter Sustaining Voltage	V <sub>CE0(sus)</sub>	I <sub>C</sub> = 0.1A	Min 400	V
Collector Cutoff Current	I <sub>CB0</sub>	At rated Voltage	Max 0.1	mA
	I <sub>CE0</sub>		Max 0.1	
Emitter Cutoff Current	I <sub>EBO</sub>	At rated Voltage	Max 0.1	mA
DC Current Gain	h <sub>FE</sub>	V <sub>CE</sub> = 2V, I <sub>C</sub> = 4A	10 ~ 25	
	h <sub>FEL</sub>	V <sub>CE</sub> = 2V, I <sub>C</sub> = 1mA	Min 10	
Collector to Emitter Saturation Voltage	V <sub>CE(sat)</sub>	I <sub>C</sub> = 4A	Max 1.0	V
Base to Emitter Saturation Voltage	V <sub>BE(sat)</sub>	I <sub>B</sub> = 0.8A	Max 1.5	V
Thermal Resistance	θ <sub>JC</sub>	Junction to case	Max 2.78	/W
Transition Frequency	f <sub>T</sub>	V <sub>CE</sub> = 10V, I <sub>C</sub> = 0.8A	TYP 13	MHz
Turn on Time	t <sub>on</sub>	I <sub>C</sub> = 4A	Max 0.3	μs
Storage Time	t <sub>s</sub>	I <sub>B1</sub> = 0.8A, I <sub>B2</sub> = 1.6A	Max 1.3	
Fall Time	t <sub>f</sub>	R <sub>L</sub> = 37.5 , V <sub>BB2</sub> = 4V	Max 0.1	

# 2SC4834

$h_{FE} - I_C$

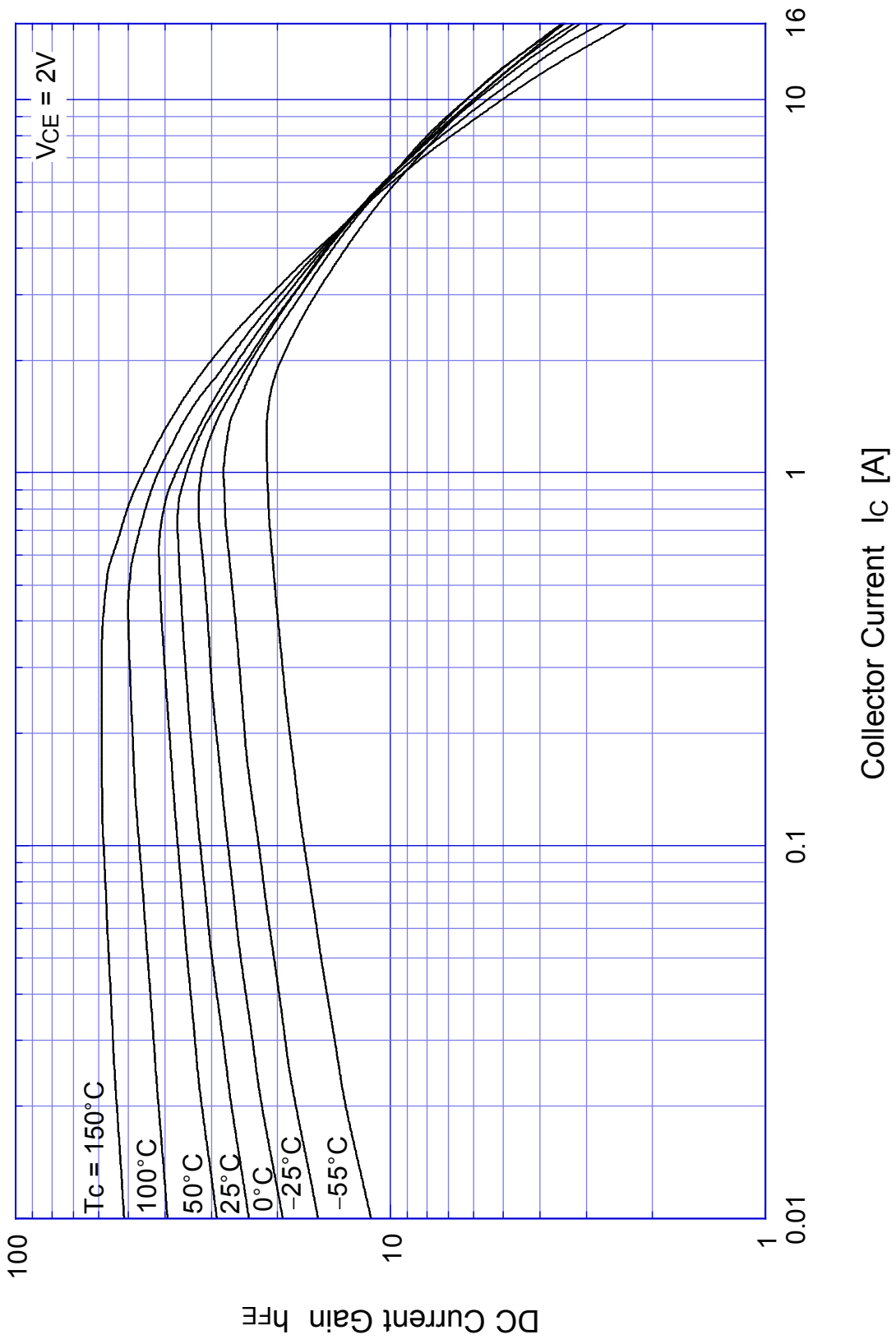

# 2SC4834 Saturation Voltage

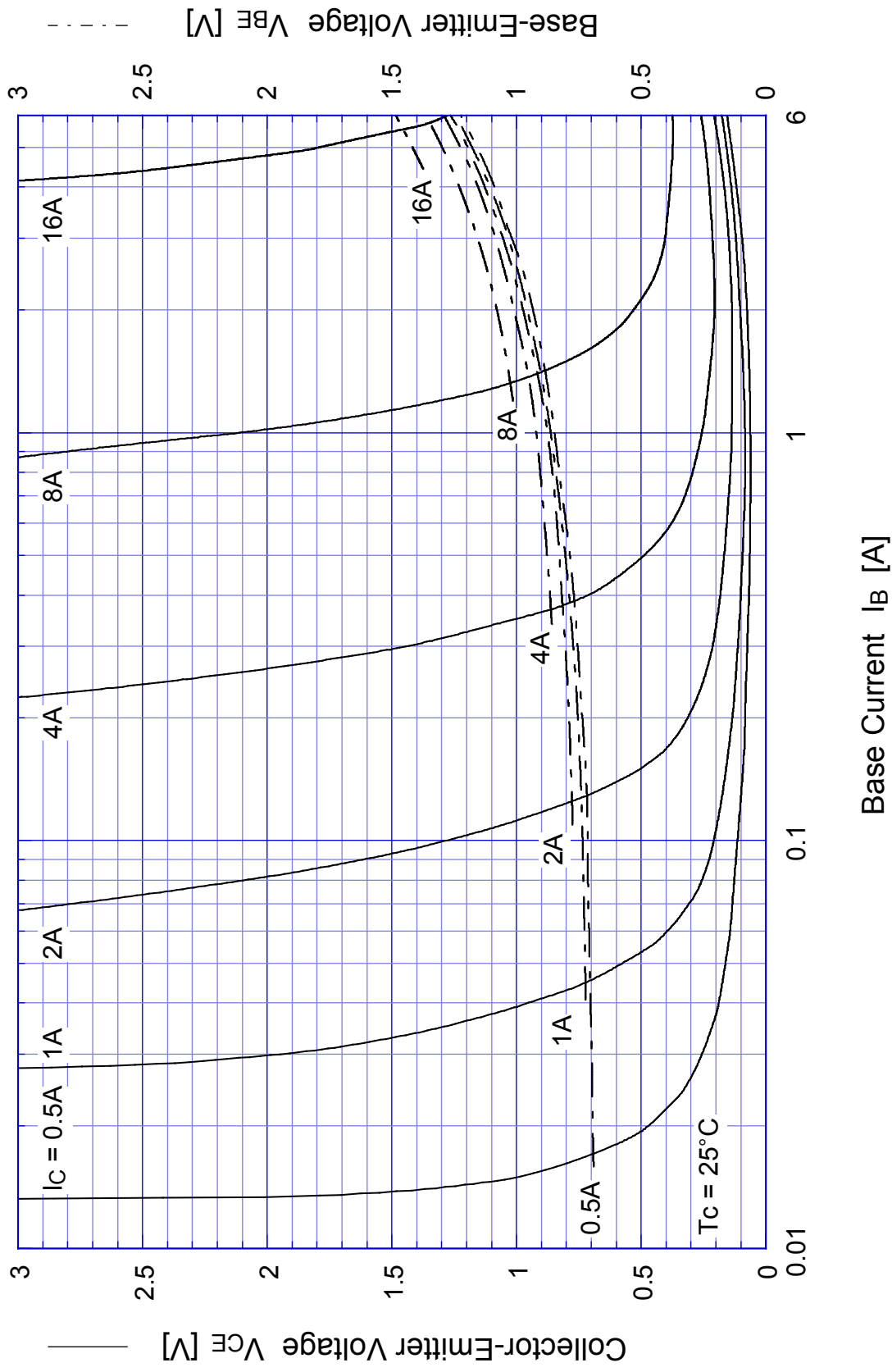

# 2SC4834

## Switching Time - $I_C$

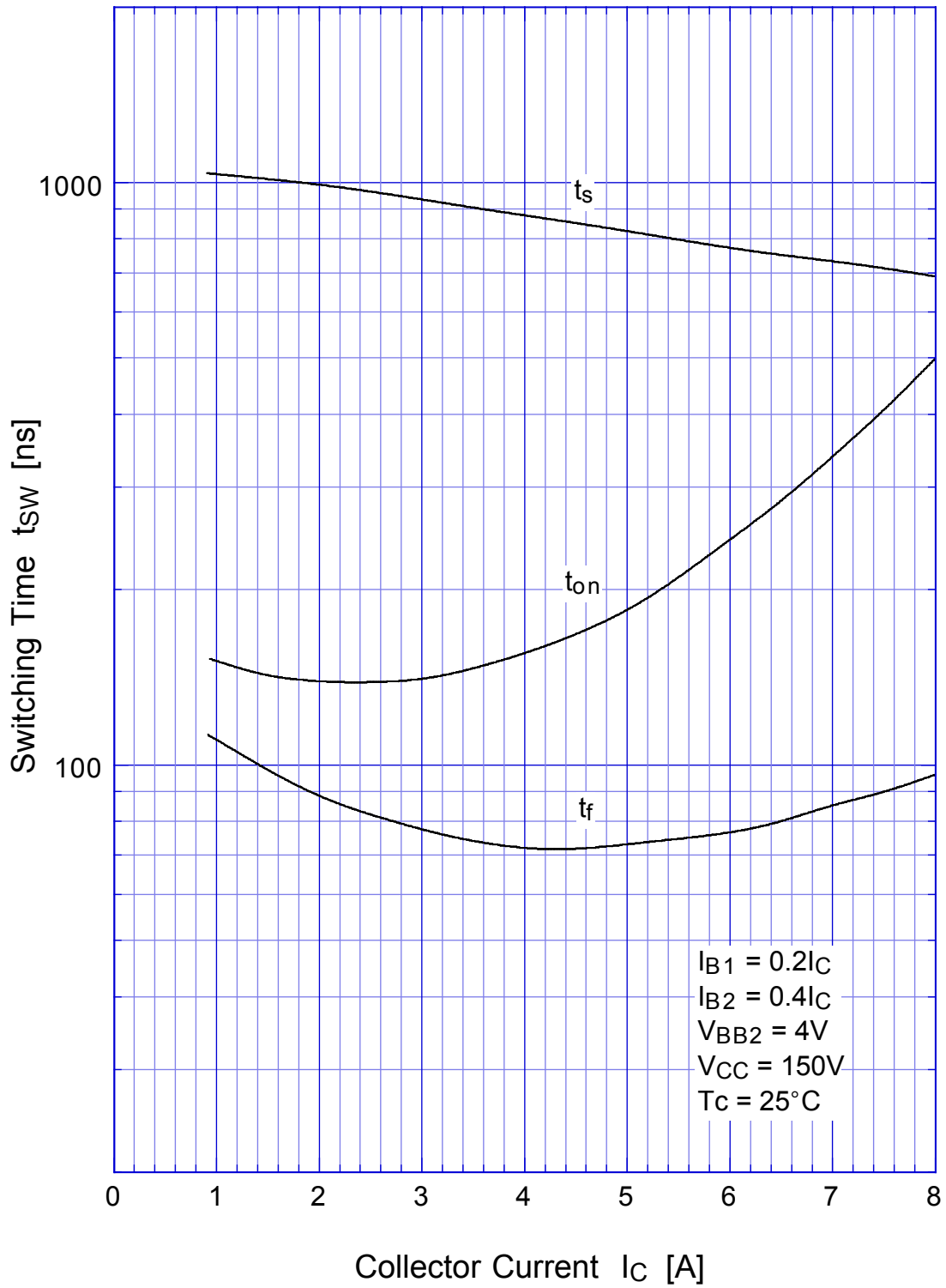

# 2SC4834

## Switching Time - Tc

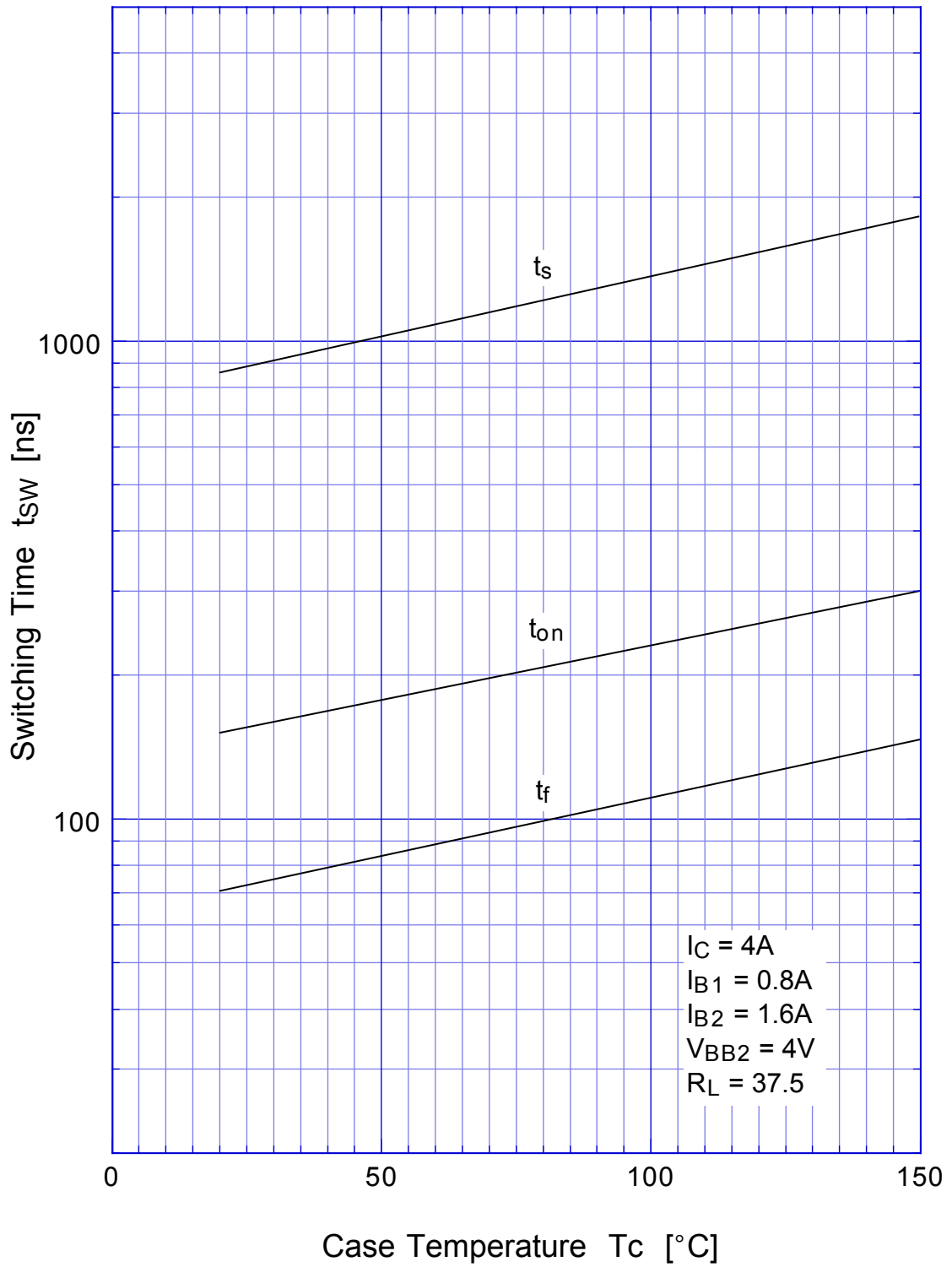

# 2SC4834

# Forward Bias SOA

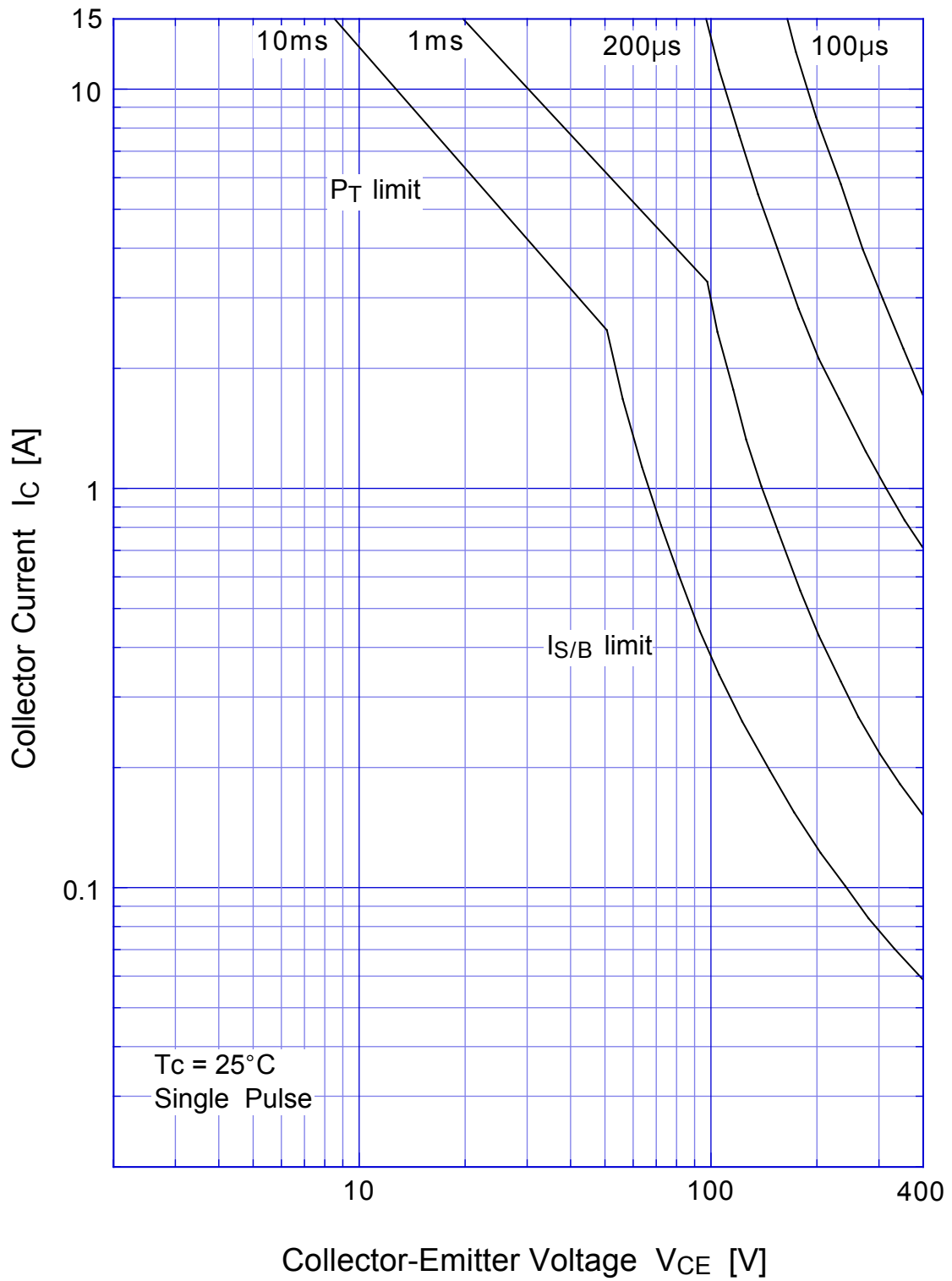

## 2SC4834 Collector Current Derating

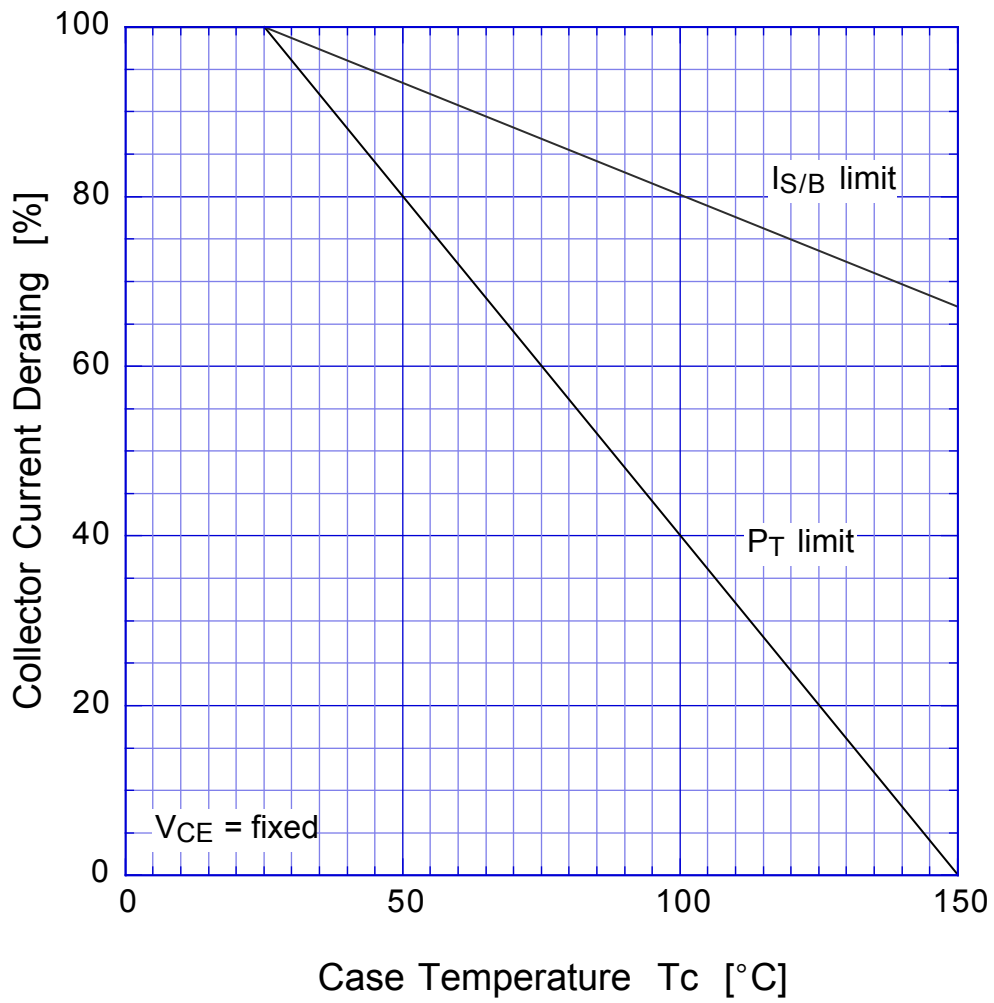

2SC4834

Reverse Bias SOA

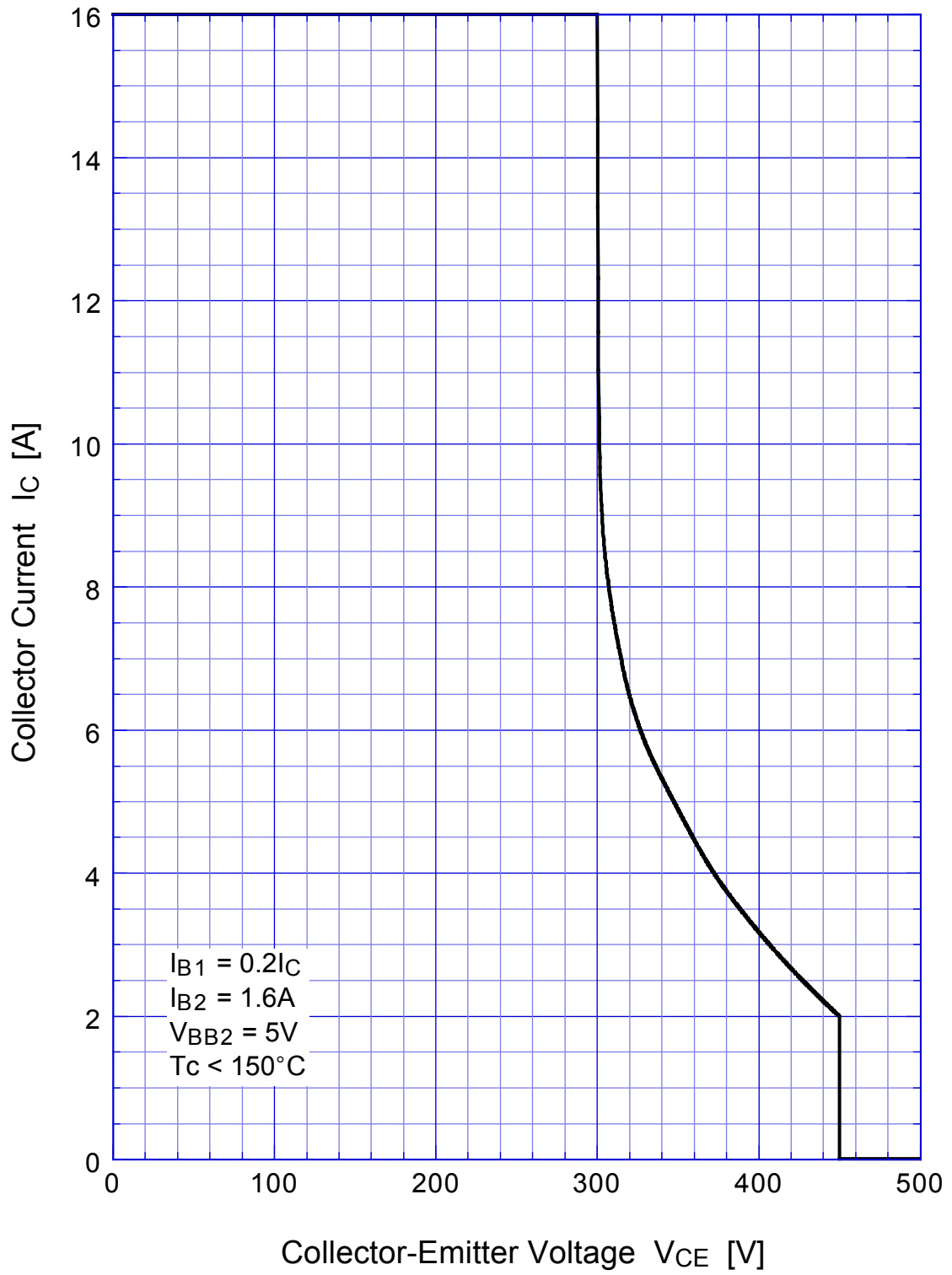



# 2SC4834 Transient Thermal Impedance

