

SCHOTTKY RECTIFIER

20 Amp

Major Ratings and Characteristics

Characteristics	20TQ...	Units
$I_{F(AV)}$ Rectangular waveform	20	A
V_{RRM} range	35 to 45	V
I_{FSM} @ $t_p = 5 \mu s$ sine	1800	A
V_F @ 20 Apk, $T_J = 125^\circ C$	0.51	V
T_J range	-55 to 150	$^\circ C$

Description/Features

The 20TQ Schottky rectifier series has been optimized for very low forward voltage drop, with moderate leakage. The proprietary barrier technology allows for reliable operation up to 150° C junction temperature. Typical applications are in switching power supplies, converters, free-wheeling diodes, and reversebattery protection.

- 150° C T_J operation
- High purity, high temperature epoxy encapsulation for enhanced mechanical strength and moisture resistance
- Low forward voltage drop
- High frequency operation
- Guard ring for enhanced ruggedness and long term reliability

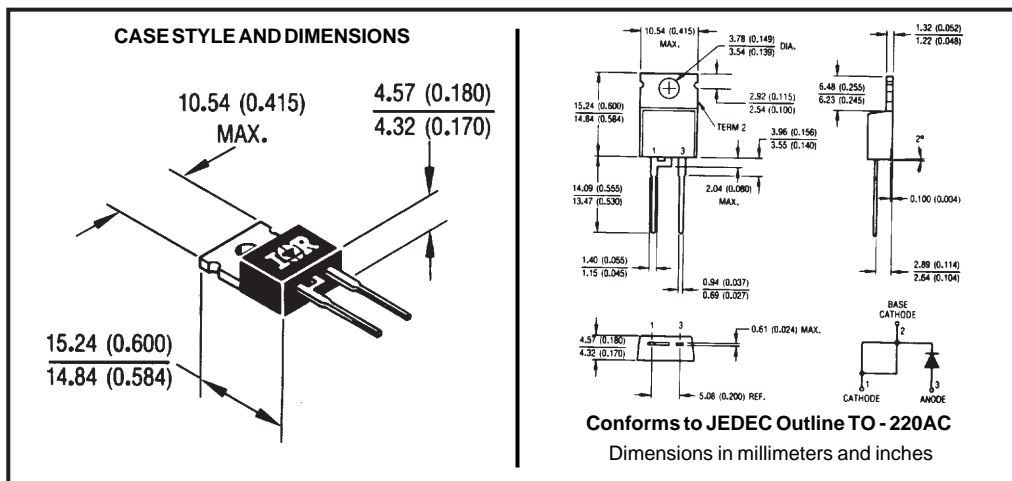

Voltage Ratings

Part number	20TQ035	20TQ040	20TQ045
V_R Max. DC Reverse Voltage (V)	35	40	45
V_{RWM} Max. Working Peak Reverse Voltage (V)			

Absolute Maximum Ratings

Parameters	20TQ	Units	Conditions
$I_{F(AV)}$ Max. Average Forward Current * See Fig. 5	20	A	50% duty cycle @ $T_C = 116^\circ\text{C}$, rectangular waveform
I_{FSM} Max. Peak One Cycle Non-Repetitive Surge Current * See Fig. 7	1800	A	5 μs Sine or 3 μs Rect. pulse
	400		10ms Sine or 6ms Rect. pulse
E_{AS} Non-Repetitive Avalanche Energy	27	mJ	$T_J = 25^\circ\text{C}$, $I_{AS} = 4$ Amps, $L = 3.4$ mH
I_{AR} Repetitive Avalanche Current	4	A	Current decaying linearly to zero in 1 μsec Frequency limited by T_J , max. $V_A = 1.5 \times V_R$ typical

Electrical Specifications

Parameters	20TQ	Units	Conditions
V_{FM} Max. Forward Voltage Drop (1) * See Fig. 1	0.57	V	@ 20A
	0.73	V	@ 40A
	0.51	V	@ 20A
	0.67	V	@ 40A
I_{RM} Max. Reverse Leakage Current (1) * See Fig. 2	2.7	mA	$T_J = 25^\circ\text{C}$
	105	mA	$T_J = 125^\circ\text{C}$
C_T Max. Junction Capacitance	1400	pF	$V_R = 5V_{DC}$, (test signal range 100Khz to 1Mhz) 25°C
L_S Typical Series Inductance	8.0	nH	Measured lead to lead 5mm from package body
dv/dt Max. Voltage Rate of Change (Rated V_R)	10,000	V/ μs	

(1) Pulse Width < 300 μs , Duty Cycle < 2%

Thermal-Mechanical Specifications

Parameters	20TQ	Units	Conditions
T_J Max. Junction Temperature Range	-55 to 150	$^\circ\text{C}$	
T_{stg} Max. Storage Temperature Range	-55 to 150	$^\circ\text{C}$	
R_{thJC} Max. Thermal Resistance Junction to Case	1.50	$^\circ\text{C/W}$	DC operation * See Fig. 4
R_{thCS} Typical Thermal Resistance, Case to Heatsink	0.50	$^\circ\text{C/W}$	Mounting surface, smooth and greased
wt Approximate Weight	2(0.07)	g(oz.)	
T Mounting Torque	Min.	6(5)	Kg-cm (lbf-in)
	Max.	12(10)	
Case Style	TO-220AC		JEDEC

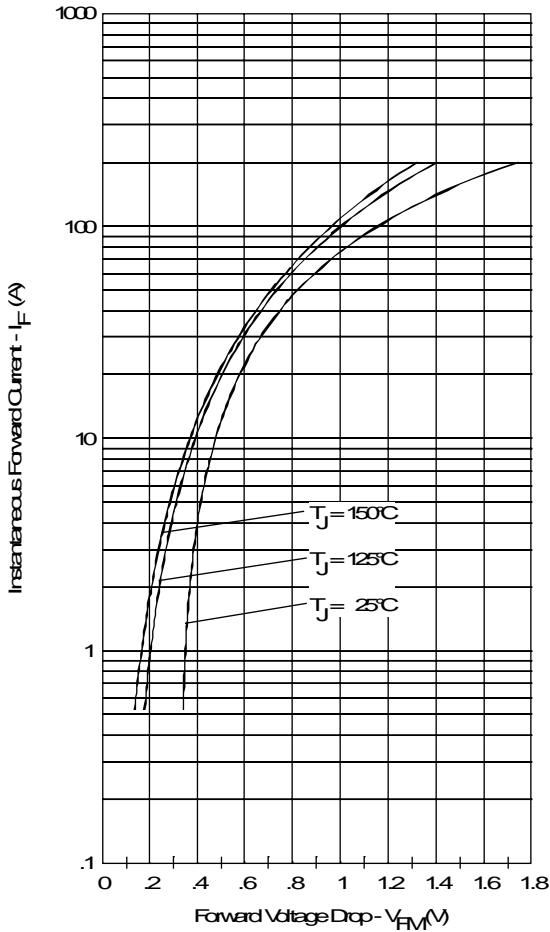

Fig. 1 - Maximum Forward Voltage Drop Characteristics

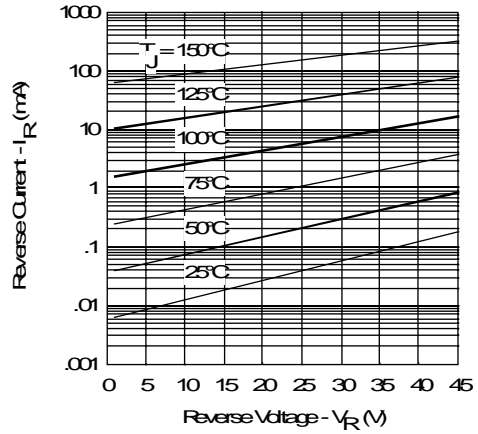

Fig. 2 - Typical Values of Reverse Current Vs. Reverse Voltage

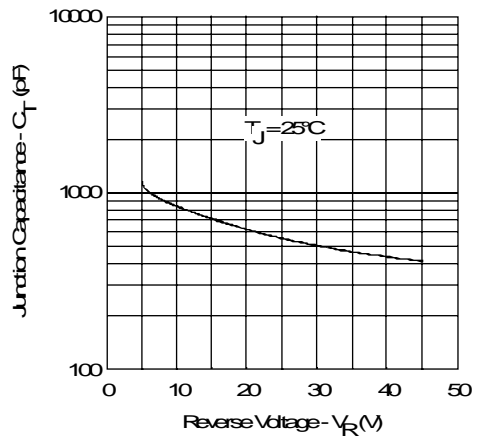

Fig. 3 - Typical Junction Capacitance Vs. Reverse Voltage

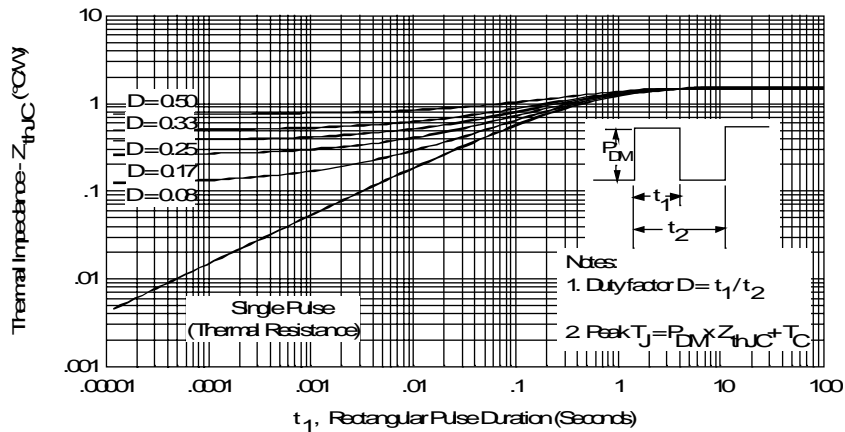

Fig. 4 - Maximum Thermal Impedance Z_{thJC} Characteristics

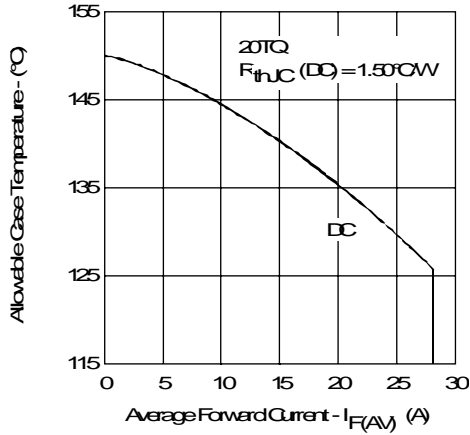

Fig. 5 - Maximum Allowable Case Temperature Vs. Average Forward Current

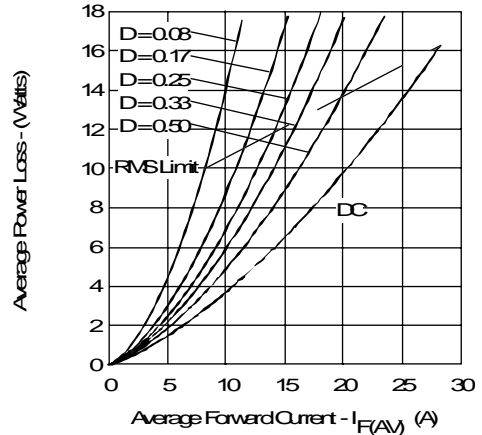

Fig. 6 - Forward Power Loss Characteristics

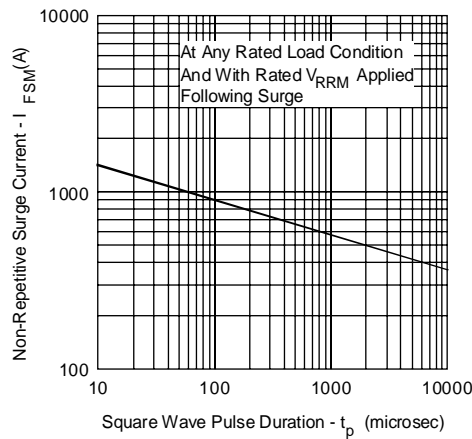

Fig. 7 - Maximum Non-Repetitive Surge Current

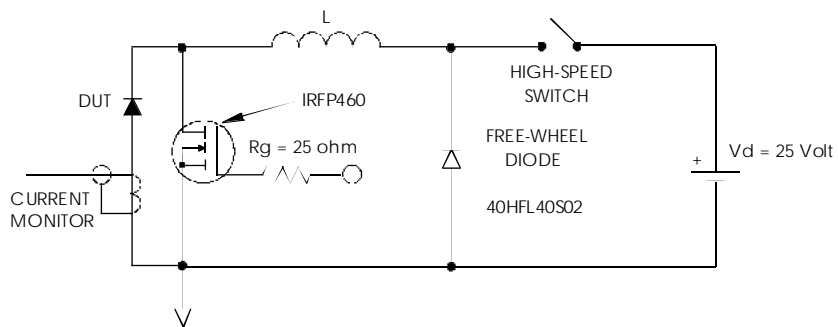

Fig. 8 - Unclamped Inductive Test Circuit